

3.6MHz, Rail-to-Rail I/O CMOS Operational Amplifier

FEATURES

- **HIGH GAIN BANDWIDTH: 3.6MHz**
- **RAIL-TO-RAIL INPUT AND OUTPUT**
0.8mV Typical Vos
- **INPUT VOLTAGE RANGE: -0.1V to +5.6V**
with Vs = 5.5V
- **SUPPLY RANGE: +2.5V to +5.5V**
- **SHUTDOWN: RS521S/RS522S**
- **SPECIFIED UP TO +125°C**
- **MicroSIZE PACKAGES: SOT23-5, SOT23-6**

APPLICATIONS

- **SENSORS**
- **PHOTODIODE AMPLIFICATION**
- **ACTIVE FILTERS**
- **TEST EQUIPMENT**
- **DRIVING A/D CONVERTERS**

DESCRIPTION

The RS52X families of products offer low voltage operation and rail-to-rail input and output, as well as excellent speed/power consumption ratio, providing an excellent bandwidth (3.6MHz) and slew rate of 1.8V/us. The op-amps are unity gain stable and feature an ultra-low input bias current.

The devices are ideal for sensor interfaces, active filters and portable applications. The RS521S, RS522S include a shutdown mode. Under logic control, the amplifiers can be switched from normal operation to a standby current that is less than 1uA. The RS52X families of operational amplifiers are specified at the full temperature range of -40°C to +125°C under single or dual power supplies of 2.5V to 5.5V.

PIN CONFIGURATIONS

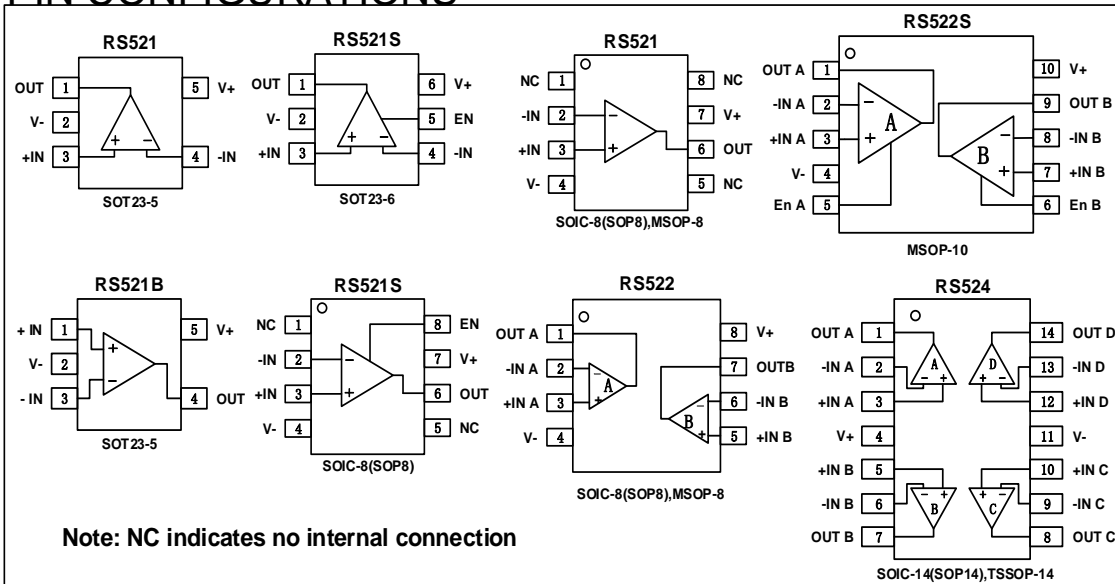

ABSOLUTE MAXIMUM RATINGS ⁽¹⁾

Supply Voltage, V+ to V-.....	7.0V
Input Terminals, Voltage ⁽²⁾	- 0.5 to (V+) + 0.5V
Current ⁽²⁾	±10mA
Storage Temperature	-65°C to +150°C
Operating Temperature	-40°C to +125°C
Junction Temperature.....	150°C
Package Thermal Resistance @ T _A = +25°C	
SOT23-5, SOT23-6.....	200°C/W
MSOP-10, SOIC-8	150°C/W
SOIC-14, TSSOP-14.....	100°C/W
Lead Temperature (Soldering, 10s)	260°C
ESD Susceptibility	
HBM	5000V
MM	400V



ESD SENSITIVITY CAUTION

ESD damage can range from subtle performance degradation to complete device failure. Precision integrated circuits may be more susceptible to damage because very small parametric changes could cause the device not to meet its published specifications.

(1) Stresses above these ratings may cause permanent damage. Exposure to absolute maximum conditions for extended periods may degrade device reliability. These are stress ratings only, and functional operation of the device at these or any other conditions beyond those specified is not implied.

(2) Input terminals are diode-clamped to the power-supply rails. Input signals that can swing more than 0.5V beyond the supply rails should be current-limited to 10mA or less.

PACKAGE/ORDERING INFORMATION

PRODUCT	ORDERING NUMBER	TEMPERATURE RANGE	PACKAGE LEAD	PACKAGE MARKING	PACKAGE OPTION
RS521	RS521XK	-40°C~125°C	SOIC-8(SOP8)	RS521	Tape and Reel,2500
	RS521XF	-40°C~125°C	SOT23-5	521	Tape and Reel,3000
	RS521BXF	-40°C~125°C	SOT23-5	521B	Tape and Reel,3000
	RS521XM	-40°C~125°C	MSOP-8	RS521	Tape and Reel,3000
RS521S	RS521SXK	-40°C~125°C	SOIC-8(SOP8)	RS521S	Tape and Reel,2500
	RS521SXH	-40°C~125°C	SOT23-6	521S	Tape and Reel,3000
RS522	RS522XK	-40°C~125°C	SOIC-8(SOP8)	RS522	Tape and Reel,2500
	RS522XM	-40°C~125°C	MSOP-8	RS522	Tape and Reel,3000
RS522S	RS522SXN	-40°C~125°C	MSOP-10	RS522S	Tape and Reel,3000
RS524	RS524XP	-40°C~125°C	SOIC-14(SOP14)	RS524	Tape and Reel,2500
	RS524XQ	-40°C~125°C	TSSOP-14	RS524	Tape and Reel,3000

ELECTRICAL CHARACTERISTICS

 (At $T_A = +25^\circ\text{C}$, $V_S = 5\text{V}$, $R_L = 10\text{k}\Omega$ connected to $V_S/2$, and $V_{OUT} = V_S/2$, unless otherwise noted.)

PARAMETER		CONDITIONS	T_J	RS521S, RS522S, RS521, RS522, RS524			UNIT
				MIN	TYP	MAX	
POWER SUPPLY							
V_S	Operating Voltage Range		25°C	2.5		5.5	V
I_Q	Quiescent Current/Amplifier		25°C		260	350	μA
PSRR	Power-Supply Rejection Ratio	$V_S = 2.5\text{V to } 5.5\text{V}$, $V_{cm} = (V_-) + 0.5\text{V}$	25°C	76	86		dB
			$-40^\circ\text{C to } 125^\circ\text{C}$	69			
INPUT							
V_{os}	Input Offset Voltage		25°C		0.8	3	mV
$V_{os\ TC}$	Input Offset Voltage Average Drift	$-40^\circ\text{C to } 125^\circ\text{C}$			2		$\mu\text{V}/^\circ\text{C}$
I_B	Input Bias Current		25°C		1	10	pA
I_{os}	Input Offset Current		25°C		1	10	pA
V_{cm}	Common-Mode Voltage Range	$V_S = 5.5\text{V}$	25°C	-0.1		5.6	V
CMRR	Common-Mode Rejection Ratio	$V_S = 5.5\text{V}$, $V_{cm} = -0.1\text{V to } 4\text{V}$	25°C	76	87		dB
			$-40^\circ\text{C to } 125^\circ\text{C}$	71			
			25°C	62	71		
			$-40^\circ\text{C to } 125^\circ\text{C}$	60			
OUTPUT							
AOL	Open-Loop Voltage Gain	$R_L = 2\text{k}\Omega$, $V_o = 0.15\text{V to } 4.85\text{V}$	25°C	100	107		dB
			$-40^\circ\text{C to } 125^\circ\text{C}$	86			
			25°C	100	110		
			$-40^\circ\text{C to } 125^\circ\text{C}$	87			
	Output Swing From Rail	$R_L = 2\text{k}\Omega$ $R_L = 10\text{k}\Omega$	25°C		31 7		mV
I_{out}	Output Short-Circuit Current		25°C		80		mA
FREQUENCY RESPONSE							
SR	Slew Rate		25°C		1.8		V/ μs
GBP	Gain-Bandwidth Product		25°C		3.6		MHz
PM	Phase Margin		25°C		65		$^\circ$
t_s	Setting Time, 0.1%				0.5		μs
	Overload Recovery Time	$V_{IN} \cdot \text{Gain} \geq V_S$			0.7		μs
NOISE							
e_n	Input Voltage Noise Density	$f = 1\text{KHz}$	25°C		15		$\text{nV}/\sqrt{\text{Hz}}$
		$f = 10\text{KHz}$	25°C		13		$\text{nV}/\sqrt{\text{Hz}}$
ENABLE/SHUTDOWN(RS521S,RS522S)							
$I_{Q(OFF)}$	Supply Current in Shutdown		25°C		<1		μA
t_{OFF}			25°C		3		μs
t_{ON}			25°C		20		μs
V_L	Shut Down		25°C	V_-		$(V_-) + 0.8$	V
V_H	Amplifier Is Active		25°C	$(V_-) + 2$		V_+	V

TYPICAL CHARACTERISTICS

At $T_A = +25^\circ\text{C}$, $V_S=5\text{V}$, $R_L = 10\text{k}\Omega$ connected to $V_S/2$, $V_{OUT} = V_S/2$, unless otherwise noted.

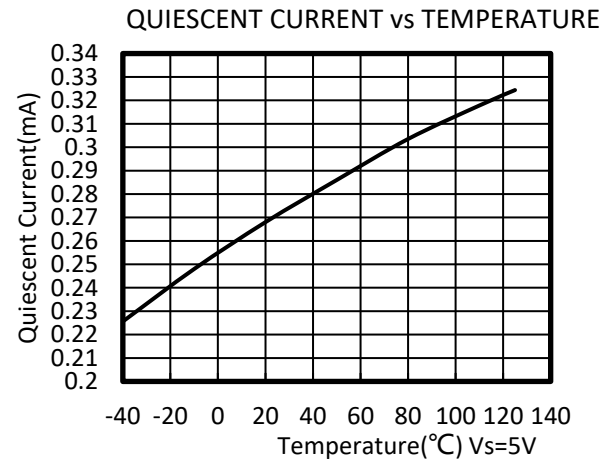
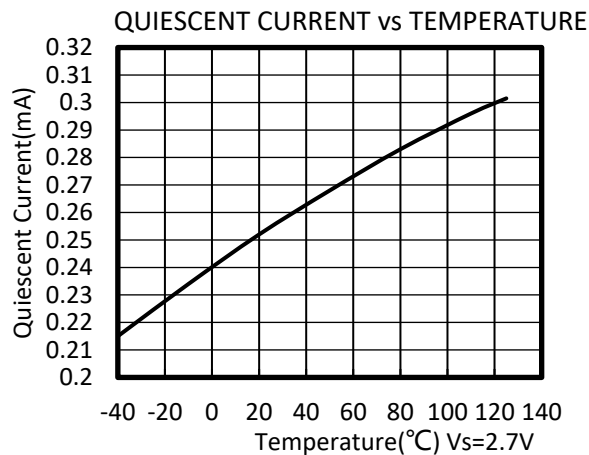
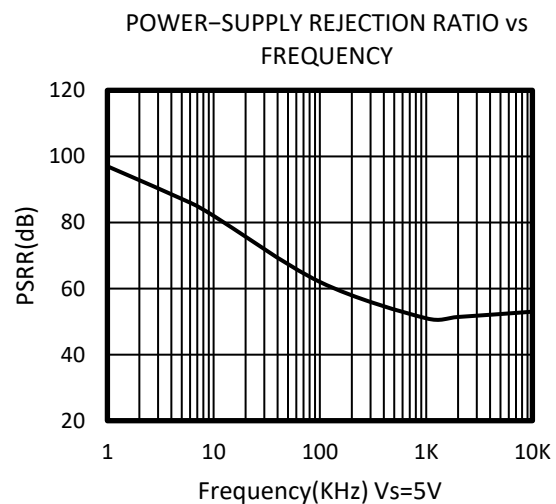
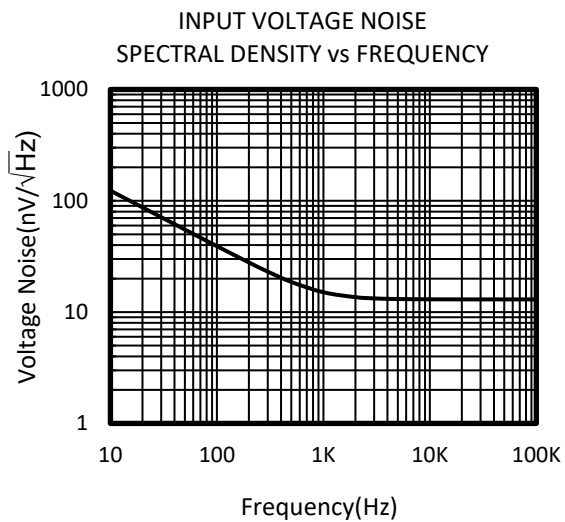
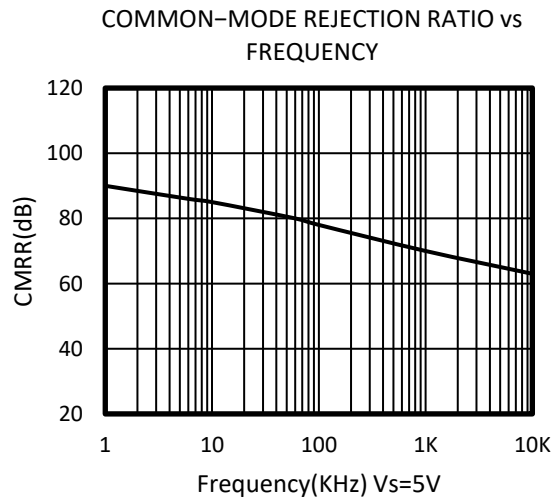
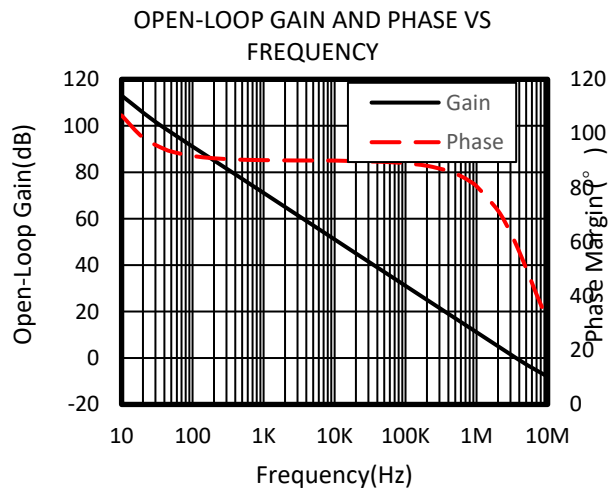

TYPICAL CHARACTERISTICS

At $T_A = +25^\circ\text{C}$, $V_S = 5\text{V}$, $R_L = 10\text{k}\Omega$ connected to $V_S/2$, $V_{OUT} = V_S/2$, unless otherwise noted.

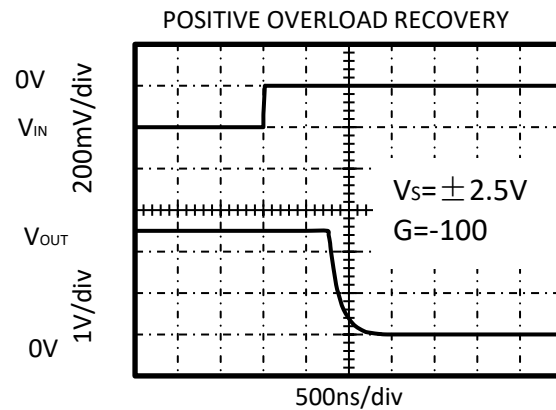
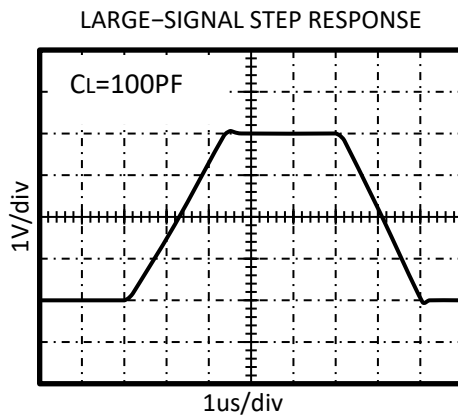
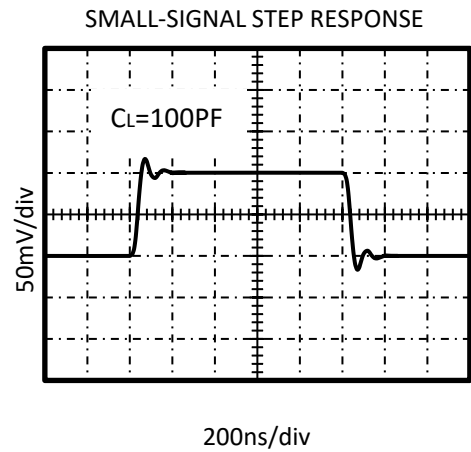
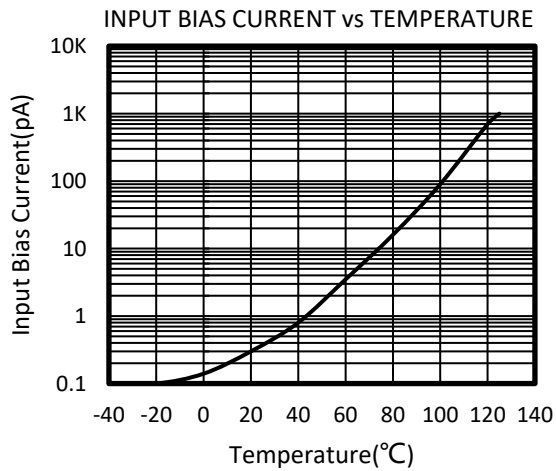
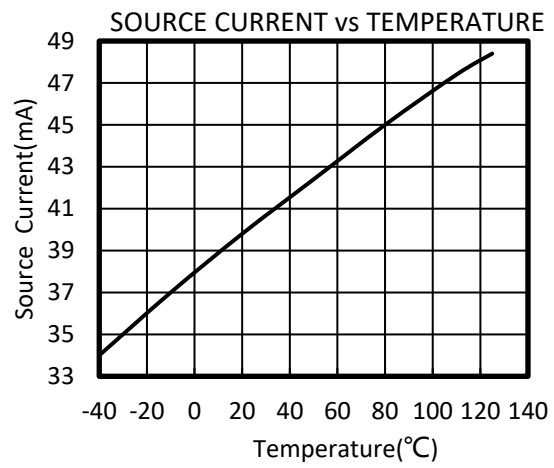
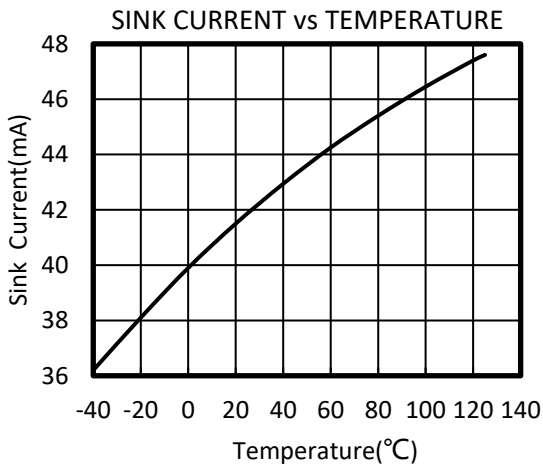

TYPICAL CHARACTERISTICS

At $T_A = +25^\circ\text{C}$, $V_S = 5\text{V}$, $R_L = 10\text{k}\Omega$ connected to $V_S/2$, $V_{OUT} = V_S/2$, unless otherwise noted.

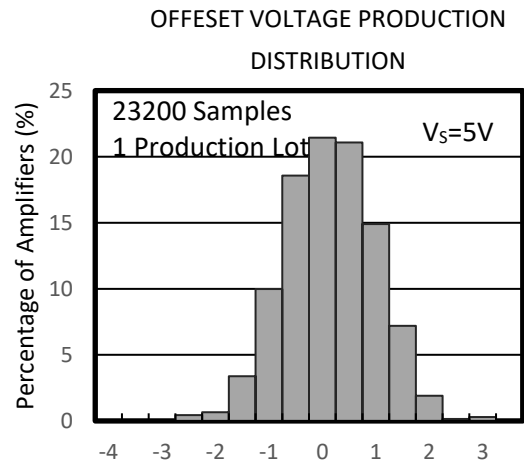
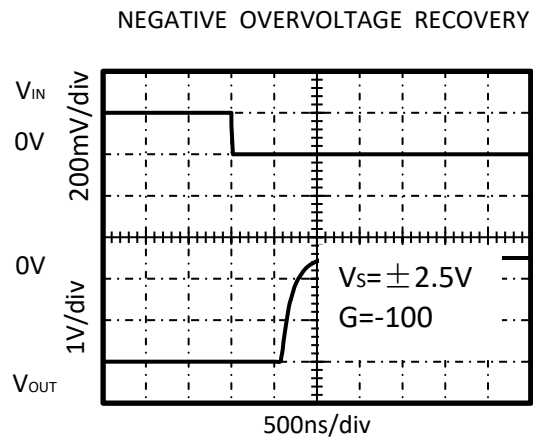

APPLICATION NOTES

The RS521, RS522, RS524, RS521S, RS522S are high precision, rail-to-rail operational amplifiers that can be run from a single-supply voltage 2.5V to 5.5V ($\pm 1.25V$ to $\pm 2.75V$). Supply voltages higher than 7V (absolute maximum) can permanently damage the amplifier.

Rail-to-rail input and output swing significantly increases dynamic range, especially in low-supply applications.

Good layout practice mandates use of a 0.1uF capacitor place closely across the supply pins.

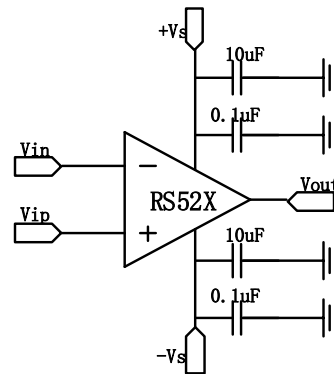

Figure1. Amplifier with Bypass Capacitors

RS521S/RS522S ENABLE FUNCTION

The RS521S/RS522S includes a shutdown mode. Under logic control, the amplifiers can be switched from normal mode to a standby current of 1uA. When the Enable pin is connected to high, the amplifier is active. Connecting Enable low disables the amplifier, and places the amplifier, and place the output in a high-impedance state.

LAYOUT GUIDELINS

Attention to good layout practices is always recommended. Keep traces short. When possible, use a PCB ground plane with surface-mount components placed as close to the device pins as possible. Place a 0.1uF capacitor closely across the supply pins.

These guidelines should be applied throughout the analog circuit to improve performance and provide benefits such as reducing the EMI susceptibility.

INSTRUMENTATION AMPLIFIER

In the three-op amp, instrumentation amplifier configuration shown in Figure2,

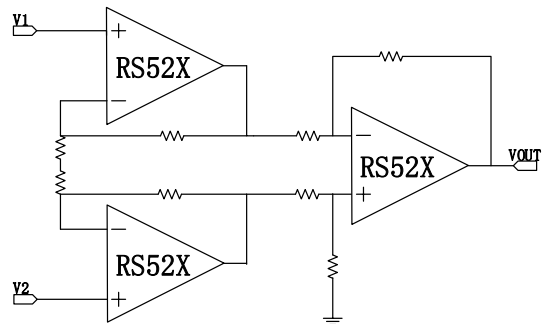
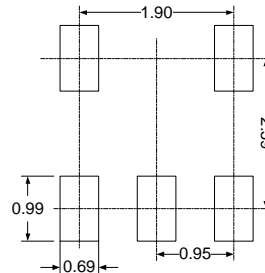
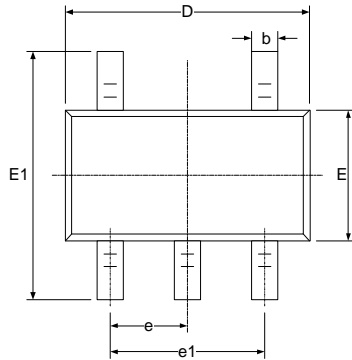

Figure2. Amplifier instrumentation amplifier

PACKAGE OUTLINE DIMENSIONS

SOT23-5



RECOMMENDED LAND PATTERN (Unit: mm)

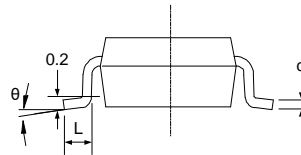
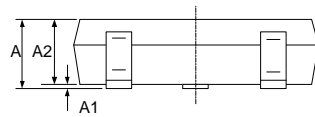

Symbol	Dimensions In Millimeters		Dimensions In Inches	
	Min	Max	Min	Max
A	1.050	1.250	0.041	0.049
A1	0.000	0.100	0.000	0.004
A2	1.050	1.150	0.041	0.045
b	0.300	0.500	0.012	0.020
c	0.100	0.200	0.004	0.008
D	2.820	3.020	0.111	0.119
E	1.500	1.700	0.059	0.067
E1	2.650	2.950	0.104	0.116
e	0.950(BSC)		0.037(BSC)	
e1	1.800	2.000	0.071	0.079
L	0.300	0.600	0.012	0.024
θ	0°	8°	0°	8°

SOT23-6

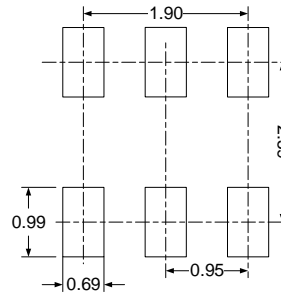
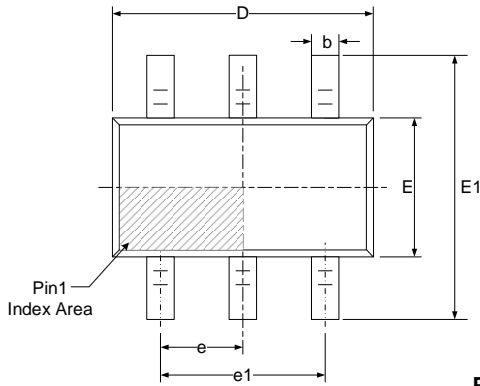

RECOMMENDED LAND PATTERN (Unit: mm)

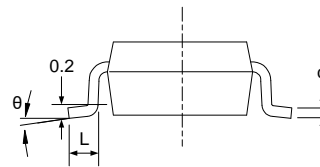
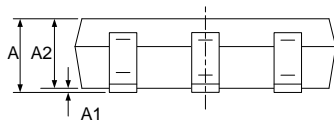

Symbol	Dimensions In Millimeters		Dimensions In Inches	
	Min	Max	Min	Max
A	1.050	1.250	0.041	0.049
A1	0.000	0.100	0.000	0.004
A2	1.050	1.150	0.041	0.045
b	0.300	0.500	0.012	0.020
c	0.100	0.200	0.004	0.008
D	2.820	3.020	0.111	0.119
E	1.500	1.700	0.059	0.067
E1	2.650	2.950	0.104	0.116
e	0.950(BSC)		0.037(BSC)	
e1	1.800	2.000	0.071	0.079
L	0.300	0.600	0.012	0.024
θ	0°	8°	0°	8°

MSOP-8

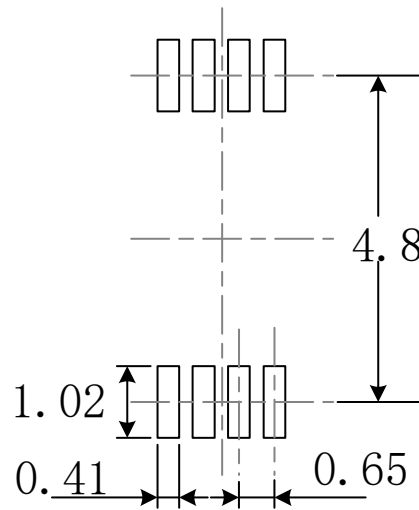
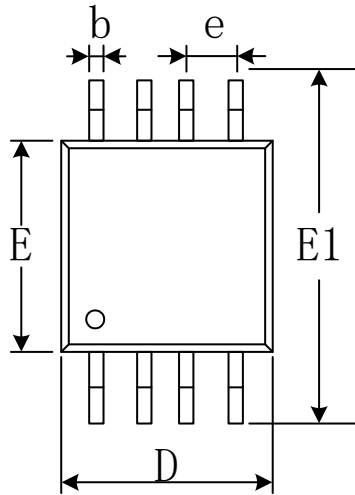

RECOMMENDED LAND PATTERN (Unit: mm)

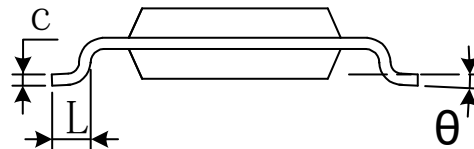
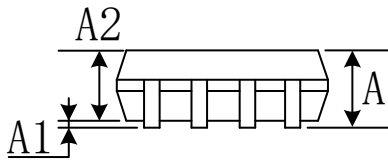

Symbol	Dimensions In Millimeters		Dimensions In Inches	
	Min	Max	Min	Max
A	0.820	1.100	0.032	0.043
A1	0.020	0.150	0.001	0.006
A2	0.750	0.950	0.030	0.037
b	0.250	0.380	0.010	0.015
c	0.090	0.230	0.004	0.009
D	2.900	3.100	0.114	0.122
e	0.650(BSC)		0.026(BSC)	
E	2.900	3.100	0.114	0.122
E1	4.750	5.050	0.187	0.199
L	0.400	0.800	0.016	0.031
θ	0°	6°	0°	6°

MSOP-10

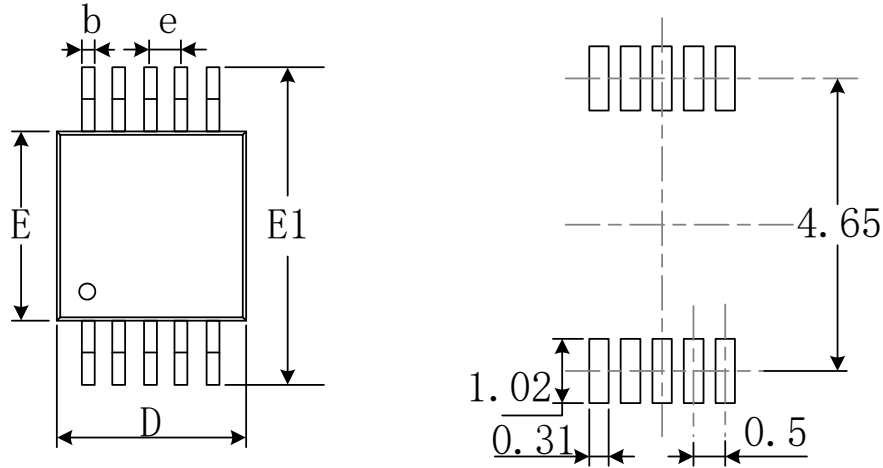

RECOMMENDED LAND PATTERN (Unit: mm)

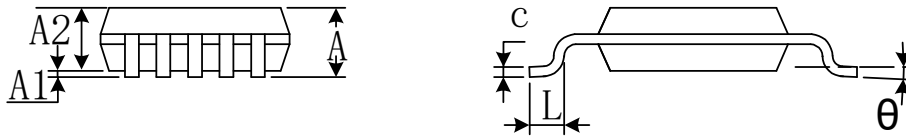

Symbol	Dimensions In Millimeters		Dimensions In Inches	
	Min	Max	Min	Max
A	0.820	1.100	0.032	0.043
A1	0.020	0.150	0.001	0.006
A2	0.750	0.950	0.030	0.037
b	0.180	0.280	0.007	0.011
c	0.090	0.230	0.004	0.009
D	2.900	3.100	0.114	0.122
e	0.50(BSC)		0.020(BSC)	
E	2.900	3.100	0.114	0.122
E1	4.750	5.050	0.187	0.199
L	0.400	0.800	0.016	0.031
θ	0°	6°	0°	6°

TSSOP-14

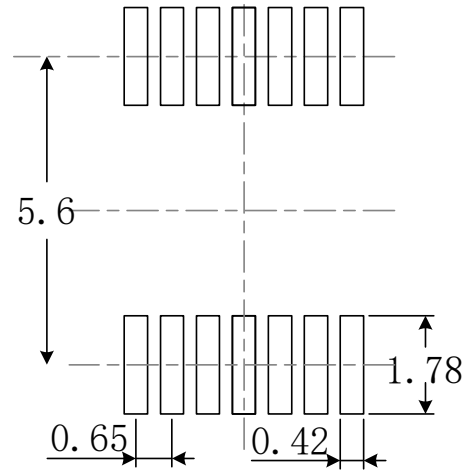
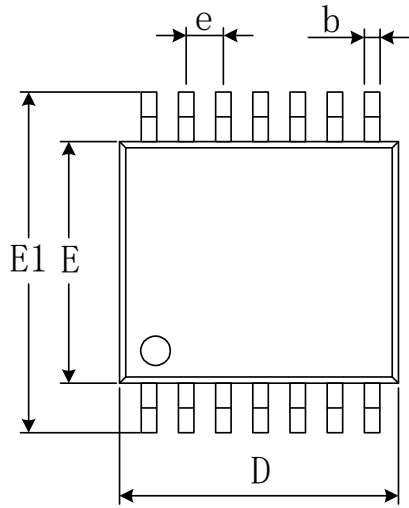

RECOMMENDED LAND PATTERN (Unit: mm)

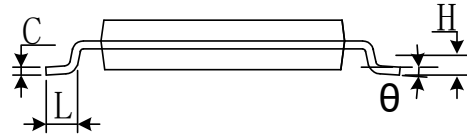
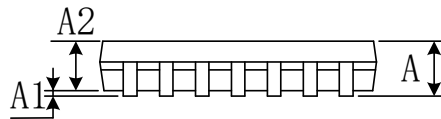

Symbol	Dimensions In Millimeters		Dimensions In Inches	
	Min	Max	Min	Max
A		1.200		0.047
A1	0.050	0.150	0.002	0.006
A2	0.800	1.050	0.031	0.041
b	0.190	0.300	0.007	0.012
c	0.090	0.200	0.004	0.008
D	4.860	5.100	0.191	0.201
E	4.300	4.500	0.169	0.177
E1	6.250	6.550	0.246	0.258
e	0.650(BSC)		0.026(BSC)	
L	0.500	0.700	0.020	0.028
H	0.25(TYP)		0.01(TYP)	
θ	1°	7°	1°	7°

SOIC-8(SOP8)

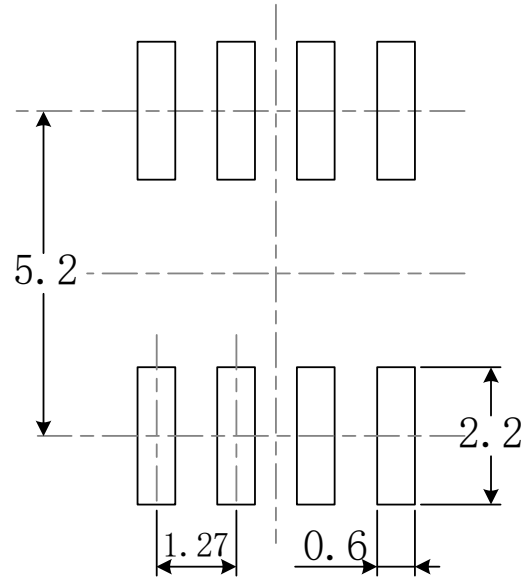
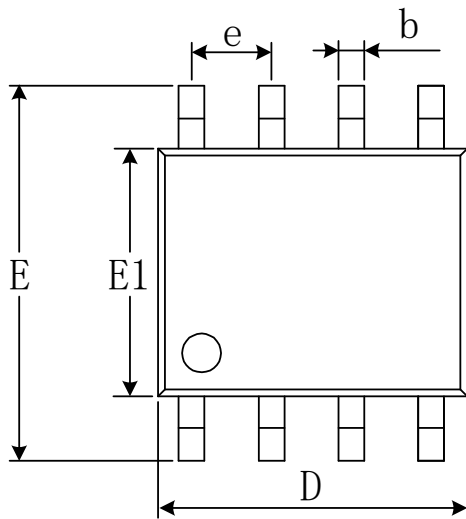

RECOMMENDED LAND PATTERN (Unit: mm)

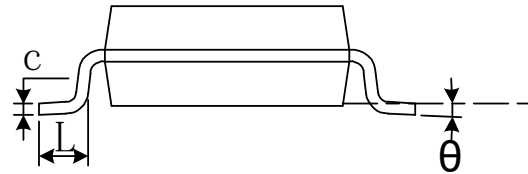
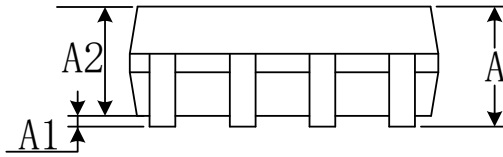

Symbol	Dimensions In Millimeters		Dimensions In Inches	
	Min	Max	Min	Max
A	1.350	1.750	0.053	0.069
A1	0.100	0.250	0.004	0.010
A2	1.350	1.550	0.053	0.061
b	0.330	0.510	0.013	0.020
c	0.170	0.250	0.007	0.010
D	4.800	5.000	0.189	0.197
e	1.270(BSC)		0.050(BSC)	
E	5.800	6.200	0.228	0.244
E1	3.800	4.000	0.150	0.157
L	0.400	1.270	0.016	0.050
θ	0°	8°	0°	8°

SOIC-14(SOP14)

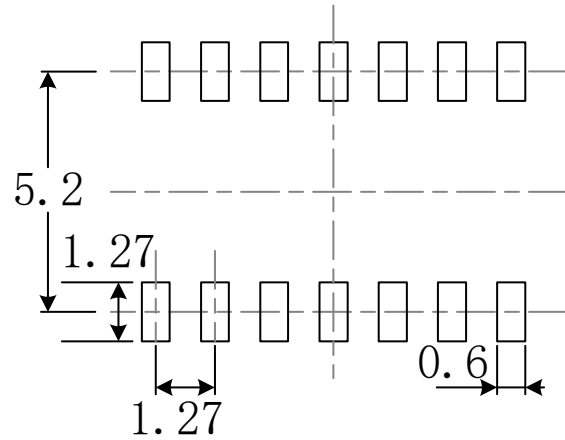
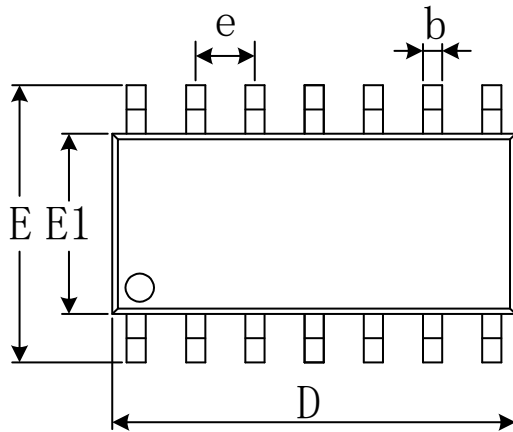

RECOMMENDED LAND PATTERN (Unit: mm)

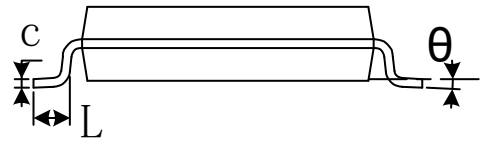
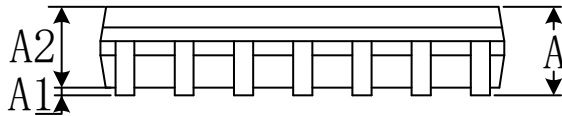

Symbol	Dimensions In Millimeters		Dimensions In Inches	
	Min	Max	Min	Max
A	1.350	1.750	0.053	0.069
A1	0.100	0.250	0.004	0.010
A2	1.350	1.550	0.053	0.061
b	0.310	0.510	0.012	0.020
c	0.100	0.250	0.004	0.010
D	8.450	8.850	0.333	0.348
e	1.270(BSC)		0.050(BSC)	
E	5.800	6.200	0.228	0.244
E1	3.800	4.000	0.150	0.157
L	0.400	1.270	0.016	0.050
θ	0°	8°	0°	8°

X-ON Electronics

Largest Supplier of Electrical and Electronic Components

Click to view similar products for [Operational Amplifiers - Op Amps](#) category:

Click to view products by [RUNIC](#) manufacturer:

Other Similar products are found below :

[430227FB](#) [AZV831KTR-G1](#) [UPC451G2-A](#) [UPC824G2-A](#) [LT1678IS8](#) [042225DB](#) [058184EB](#) [UPC822G2-A](#) [UPC258G2-A](#)
[NCS5651MNTXG](#) [NCV33202DMR2G](#) [NJM324E](#) [NTE925](#) [5962-9080901MCA*](#) [AP4310AUMTR-AG1](#) [HA1630D02MMEL-E](#)
[HA1630S01LPEL-E](#) [SCY33178DR2G](#) [NJU77806F3-TE1](#) [NCV5652MUTWG](#) [NCV20034DR2G](#) [LM2902EDR2G](#) [NTE778S](#) [NTE871](#)
[NTE924](#) [NTE937](#) [MCP6V16UT-E/OT](#) [MCP6V17T-E/MS](#) [MCP6V19T-E/ST](#) [SCY6358ADR2G](#) [LTC2065IUD#PBF](#) [NCS20282FCTTAG](#)
[LM4565FVT-GE2](#) [EL5420CRZ-T7A](#) [TSV791IYLT](#) [TSV772IQ2T](#) [TLV2772QPWR](#) [NJM2100M-TE1](#) [NJM4556AM-TE1](#) [MCP6487-E/SN](#)
[AS324MTR-E1](#) [AS358MMTR-G1](#) [MCP6232T-EMNY](#) [MCP662-E/MF](#) [TLC081AIP](#) [TLC082AIP](#) [TLE2074ACDW](#) [TLV07IDR](#)
[TLV2170IDGKT](#) [TLV2455IDR](#)