

# 7MHz, Rail-to-Rail I/O CMOS Operational Amplifier

## FEATURES

- HIGH GAIN BANDWIDTH: 7MHz
- RAIL-TO-RAIL INPUT AND OUTPUT  
0.7mV Typical Vos
- INPUT VOLTAGE RANGE: -0.1V to +5.6V  
with Vs = 5.5V
- SUPPLY RANGE: +2.5V to +5.5V
- SHUTDOWN: RS621S/RS622S
- SPECIFIED UP TO +125°C
- MicroSIZE PACKAGES: SOT23-5, SOT23-6

## APPLICATIONS

- SENSORS
- PHOTODIODE AMPLIFICATION
- ACTIVE FILTERS
- TEST EQUIPMENT
- DRIVING A/D CONVERTERS

## DESCRIPTION

The RS62X families of products offer low voltage operation and rail-to-rail input and output, as well as excellent speed/power consumption ratio, providing an excellent bandwidth (7MHz) and slew rate of 3.7V/us. The op-amps are unity gain stable and feature an ultra-low input bias current.

The devices are ideal for sensor interfaces, active filters and portable applications. The RS621S, RS622S include a shutdown mode. Under logic control, the amplifiers can be switched from normal operation to a standby current that is less than 1uA. The RS62X families of operational amplifiers are specified at the full temperature range of -40°C to +125°C under single or dual power supplies of 2.5V to 5.5V.

## PIN CONFIGURATIONS

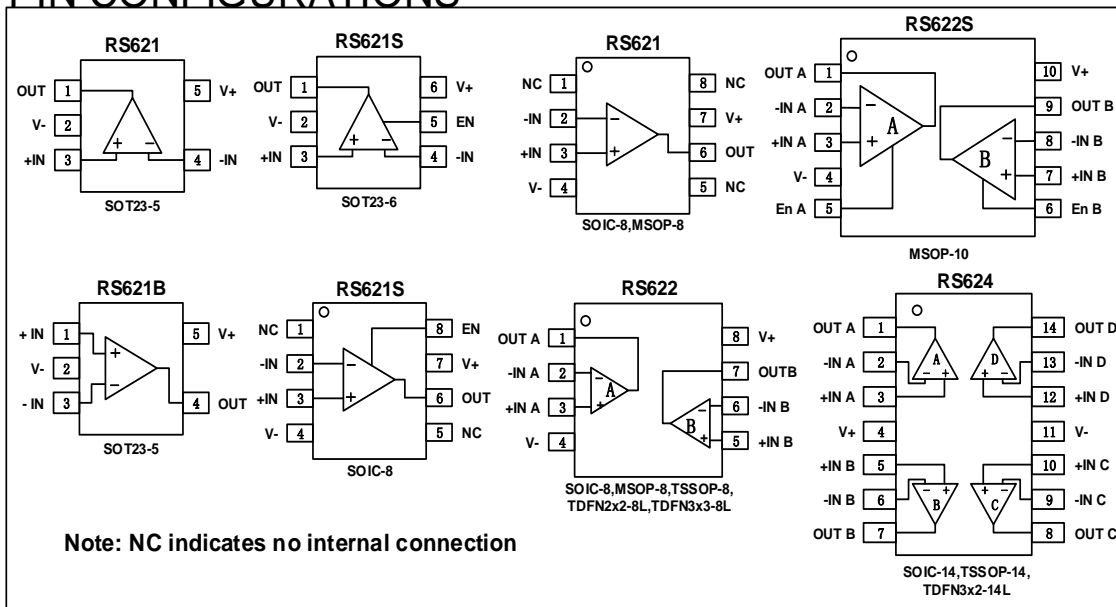

**ABSOLUTE MAXIMUM RATINGS <sup>(1)</sup>**

Supply Voltage, V+ to V-.....	7.0V
Input Terminals, Voltage <sup>(2)</sup> .....	- 0.5 to (V+) + 0.5V
Current <sup>(2)</sup> .....	±10mA
Storage Temperature .....	-65°C to +150°C
Operating Temperature .....	-40°C to +125°C
Junction Temperature.....	150°C
Package Thermal Resistance @ T <sub>A</sub> = +25°C	
SOT23-5, SOT23-6.....	200°C/W
MSOP-10, SOIC-8, TSSOP-8.....	150°C/W
SOIC-14, TSSOP-14.....	100°C/W
Lead Temperature (Soldering, 10s) .....	260°C
ESD Susceptibility	
HBM .....	5000V
MM .....	400V

(1) Stresses above these ratings may cause permanent damage. Exposure to absolute maximum conditions for extended periods may degrade device reliability. These are stress ratings only, and functional operation of the device at these or any other conditions beyond those specified is not implied.

(2) Input terminals are diode-clamped to the power-supply rails. Input signals that can swing more than 0.5V beyond the supply rails should be current-limited to 10mA or less.

**ESD SENSITIVITY CAUTION**

ESD damage can range from subtle performance degradation to complete device failure. Precision integrated circuits may be more susceptible to damage because very small parametric changes could cause the device not to meet its published specifications.

**PACKAGE/ORDERING INFORMATION**

PRODUCT	ORDERING NUMBER	TEMPERATURE RANGE	PACKAGE LEAD	PACKAGE MARKING	PACKAGE OPTION
RS621	RS621XK	-40°C~125°C	SOIC-8	RS621	Tape and Reel,2500
	RS621XF	-40°C~125°C	SOT23-5	621	Tape and Reel,3000
	RS621BXF	-40°C~125°C	SOT23-5	621B	Tape and Reel,3000
	RS621XM	-40°C~125°C	MSOP-8	RS621	Tape and Reel,3000
RS621S	RS621SXK	-40°C~125°C	SOIC-8	RS621S	Tape and Reel,2500
	RS621SXH	-40°C~125°C	SOT23-6	621S	Tape and Reel,3000
RS622	RS622XK	-40°C~125°C	SOIC-8	RS622	Tape and Reel,2500
	RS622XM	-40°C~125°C	MSOP-8	RS622	Tape and Reel,3000
	RS622XTDE8	-40°C~125°C	TDFN2x2-8L	RS622	Tape and Reel,3000
	RS622XTDC8	-40°C~125°C	TDFN3x3-8L	RS622	Tape and Reel,3000
	RS622XQ	-40°C~125°C	TSSOP-8	RS622	Tape and Reel,3000
RS622S	RS622SXN	-40°C~125°C	MSOP-10	RS622S	Tape and Reel,3000
RS624	RS624XP	-40°C~125°C	SOIC-14	RS624	Tape and Reel,2500
	RS624XQ	-40°C~125°C	TSSOP-14	RS624	Tape and Reel,3000
	RS624XTDB14	-40°C~125°C	TDFN3x2-14L	RS624	Tape and Reel,3000

**ELECTRICAL CHARACTERISTICS**

 (At  $T_A = +25^\circ\text{C}$ ,  $V_S = 5\text{V}$ ,  $R_L = 10\text{k}\Omega$  connected to  $V_S/2$ , and  $V_{OUT} = V_S/2$ , unless otherwise noted.)

PARAMETER		CONDITIONS	$T_J$	RS621S,RS622S, RS621,RS622,RS624			UNIT
				MIN	TYP	MAX	
<b>POWER SUPPLY</b>							
$V_S$	Operating Voltage Range		25°C	2.5		5.5	V
$I_Q$	Quiescent Current/Amplifier		25°C		600	800	uA
PSRR	Power-Supply Rejection Ratio	$V_S = 2.5\text{V to } 5.5\text{V}$ $V_{cm} = (V_-) + 0.5\text{V}$	25°C	78	93		dB
			-40°C to 125°C	72			
<b>INPUT</b>							
$V_{os}$	Input Offset Voltage		25°C		0.7	3	mV
$V_{os\ TC}$	Input Offset Voltage Average Drift	-40°C to 125°C			2		uV/°C
$I_B$	Input Bias Current		25°C		1	10	pA
$I_{os}$	Input Offset Current		25°C		1	10	pA
$V_{cm}$	Common-Mode Voltage Range	$V_S = 5.5\text{V}$	25°C	-0.1		5.6	V
CMRR	Common-Mode Rejection Ratio	$V_S = 5.5\text{V}$ , $V_{cm} = -0.1\text{V to } 4\text{V}$ $V_S = 5.5\text{V}$ , $V_{cm} = -0.1\text{V to } 5.6\text{V}$	25°C	74	92		dB
			-40°C to 125°C	68			
			25°C	62	83		
			-40°C to 125°C	60			
<b>OUTPUT</b>							
AOL	Open-Loop Voltage Gain	$R_L = 2\text{k}\Omega$ , $V_o = 0.15\text{V to } 4.85\text{V}$ $R_L = 10\text{k}\Omega$ , $V_o = 0.05\text{V to } 4.95\text{V}$	25°C	96	102		dB
			-40°C to 125°C	83			
			25°C	98	106		
			-40°C to 125°C	85			
	Output Swing From Rail	$R_L = 2\text{k}\Omega$ $R_L = 10\text{k}\Omega$	25°C		40		mV
			25°C		7		
$I_{out}$	Output Short-Circuit Current		25°C		50		mA
<b>FREQUENCY RESPONSE</b>							
SR	Slew Rate		25°C		3.7		V/us
GBP	Gain-Bandwidth Product		25°C		7		MHz
$\Phi_m$	Phase Margin		25°C		64		°
$t_s$	Settling Time, 0.1%				0.5		us
	Overload Recovery Time	$V_{IN} \cdot \text{Gain} \geq V_S$			0.5		us
<b>NOISE</b>							
$e_n$	Input-Referred Voltage Noise	$f = 1\text{ kHz}$	25°C		11		nV/√Hz
		$f = 10\text{ kHz}$	25°C		7.5		nV/√Hz
<b>ENABLE/SHUTDOWN(RS621S,RS622S)</b>							
$I_{Q(OFF)}$	Supply Current in Shutdown		25°C		<1		uA
$t_{OFF}$			25°C		3		us
$t_{ON}$			25°C		20		us
$V_L$	Shut Down		25°C	V-		(V-)+0.8	V
$V_H$	Amplifier Is Active		25°C	(V-)+2		V+	V

## TYPICAL CHARACTERISTICS

At  $T_A = +25^\circ\text{C}$ ,  $V_S = 5\text{V}$ ,  $R_L = 10\text{k}\Omega$  connected to  $V_S/2$ ,  $V_{OUT} = V_S/2$ , unless otherwise noted.

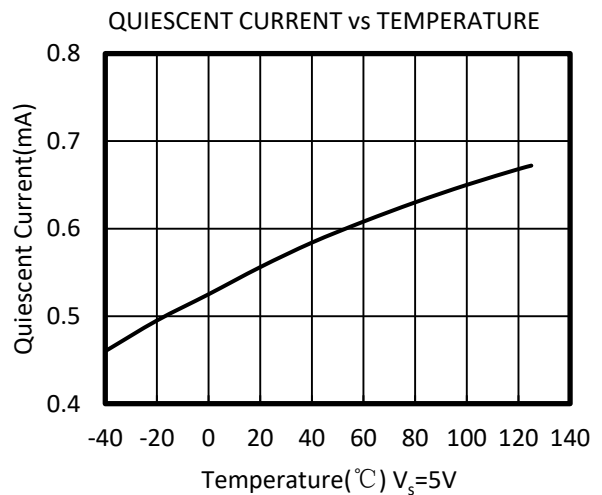
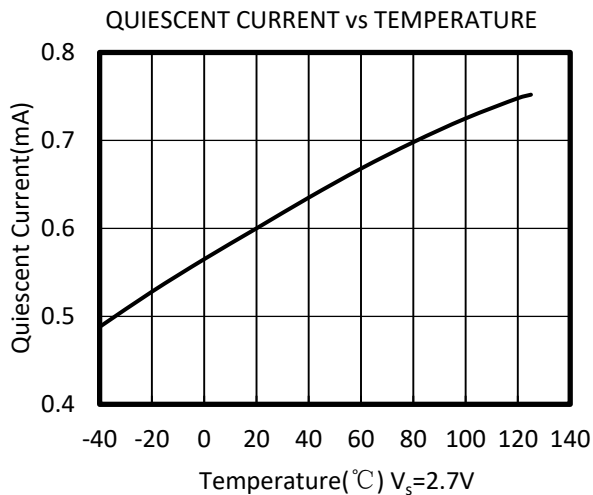
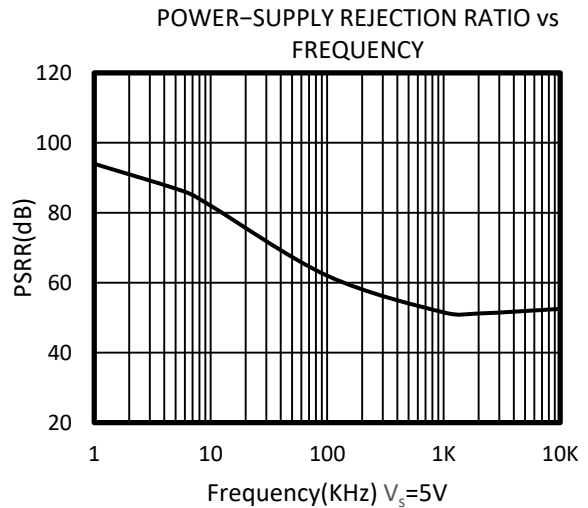
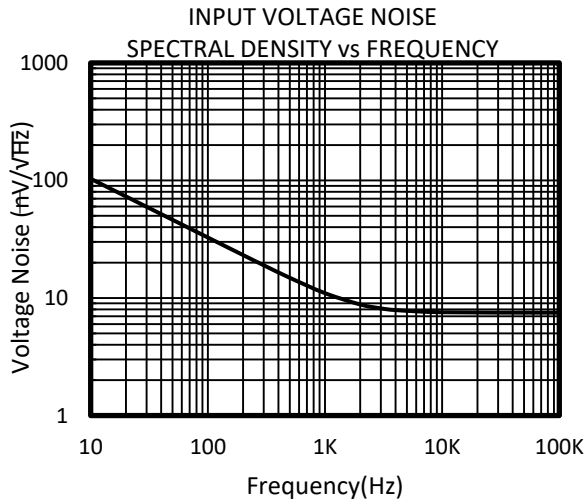
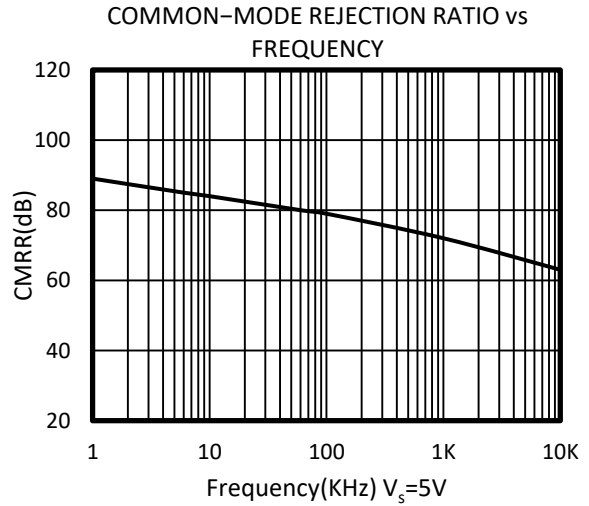
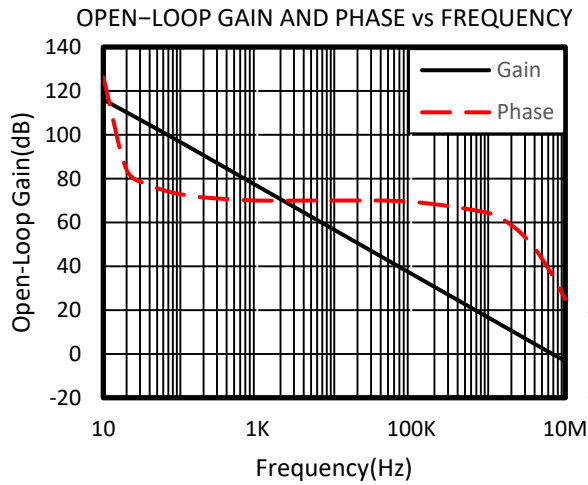

## TYPICAL CHARACTERISTICS

At  $T_A = +25^\circ\text{C}$ ,  $V_S = 5\text{V}$ ,  $R_L = 10\text{k}\Omega$  connected to  $V_S/2$ ,  $V_{OUT} = V_S/2$ , unless otherwise noted.

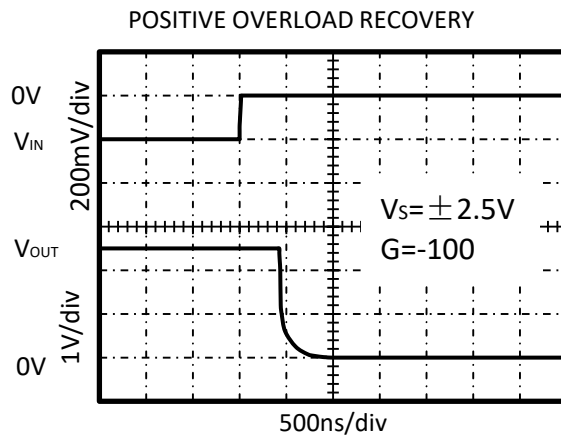
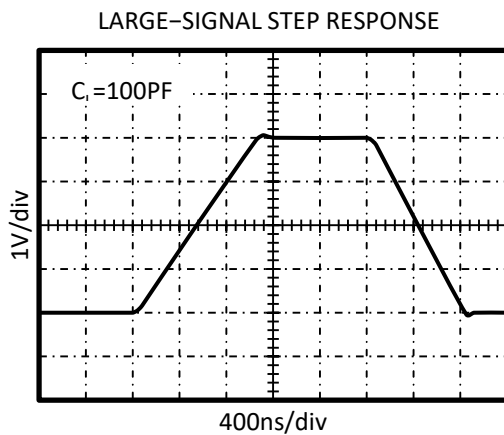
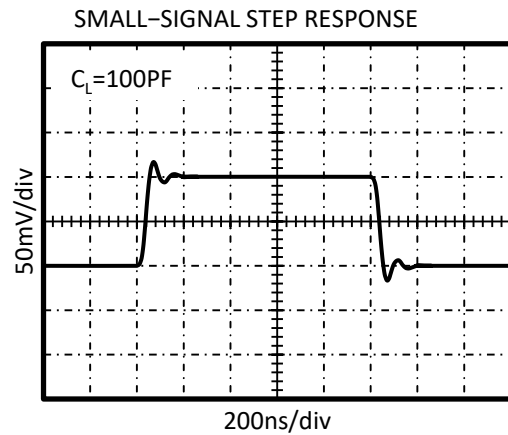
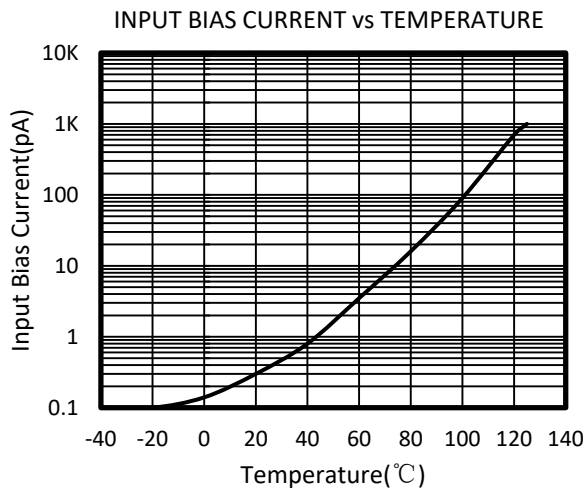
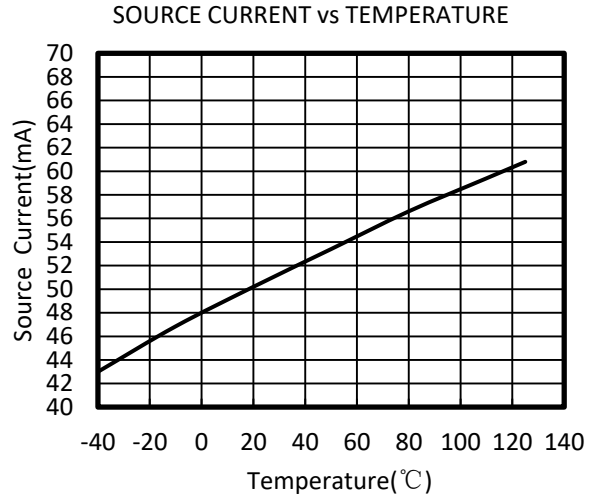
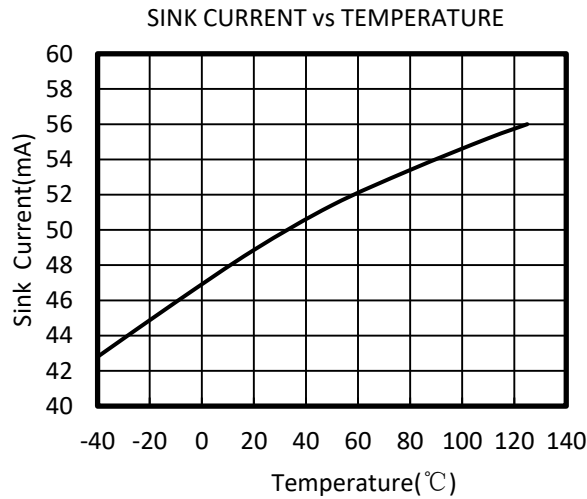

## TYPICAL CHARACTERISTICS

At  $T_A = +25^\circ\text{C}$ ,  $V_S = 5\text{V}$ ,  $R_L = 10\text{k}\Omega$  connected to  $V_S/2$ ,  $V_{OUT} = V_S/2$ , unless otherwise noted.

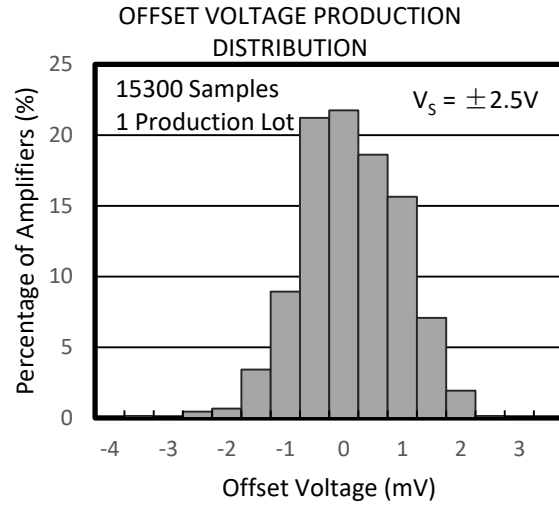
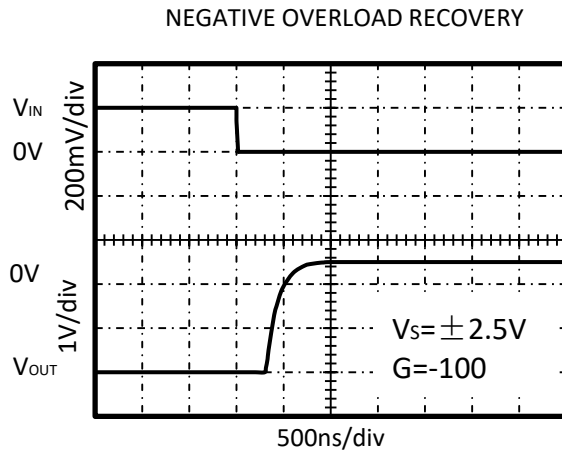

## APPLICATION NOTES

The RS621, RS622, RS624, RS621S, RS622S are high precision, rail-to-rail operational amplifiers that can be run from a single-supply voltage 2.5V to 5.5V ( $\pm 1.25V$  to  $\pm 2.75V$ ). Supply voltages higher than 7V (absolute maximum) can permanently damage the amplifier.

Rail-to-rail input and output swing significantly increases dynamic range, especially in low-supply applications.

Good layout practice mandates use of a 0.1uF capacitor place closely across the supply pins.

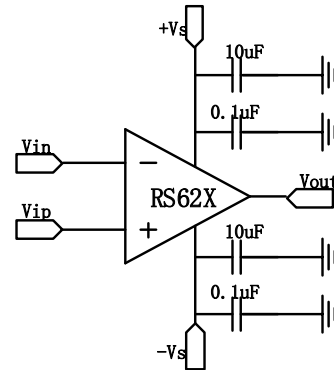

Figure1. Amplifier with Bypass Capacitors

## RS621S/RS622S ENABLE FUNCTION

The RS621S/RS622S includes a shutdown mode. Under logic control, the amplifiers can be switched from normal mode to a standby current of 1uA. When the Enable pin is connected to high, the amplifier is active. Connecting Enable low disables the amplifier, and places the amplifier, and place the output in a high-impedance state.

## LAYOUT GUIDELINS

Attention to good layout practices is always recommended. Keep traces short. When possible, use a PCB ground plane with surface-mount components placed as close to the device pins as possible. Place a 0.1uF capacitor closely across the supply pins.

These guidelines should be applied throughout the analog circuit to improve performance and provide benefits such as reducing the EMI susceptibility.

## INSTRUMENTATION AMPLIFIER

In the three-op amp, instrumentation amplifier configuration shown in Figure2,

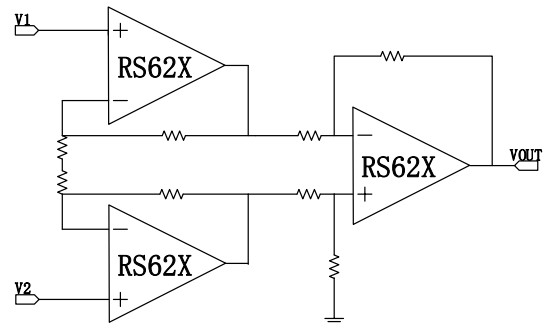
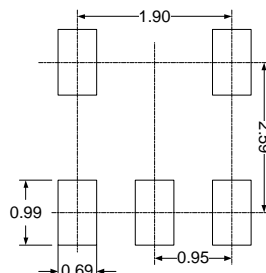
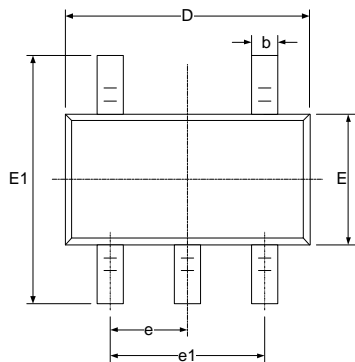

Figure2. Amplifier instrumentation amplifier

# PACKAGE OUTLINE DIMENSIONS

## SOT23-5



RECOMMENDED LAND PATTERN (Unit: mm)

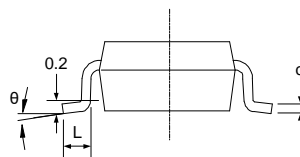
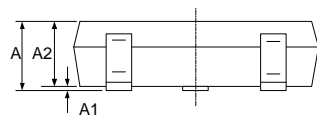

Symbol	Dimensions In Millimeters		Dimensions In Inches	
	Min	Max	Min	Max
A	1.050	1.250	0.041	0.049
A1	0.000	0.100	0.000	0.004
A2	1.050	1.150	0.041	0.045
b	0.300	0.500	0.012	0.020
c	0.100	0.200	0.004	0.008
D	2.820	3.020	0.111	0.119
E	1.500	1.700	0.059	0.067
E1	2.650	2.950	0.104	0.116
e	0.950(BSC)		0.037(BSC)	
e1	1.800	2.000	0.071	0.079
L	0.300	0.600	0.012	0.024
θ	0°	8°	0°	8°



# SOT23-6

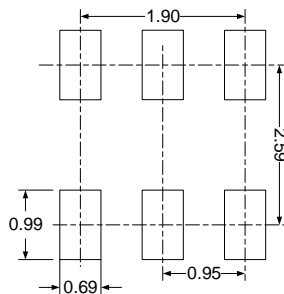
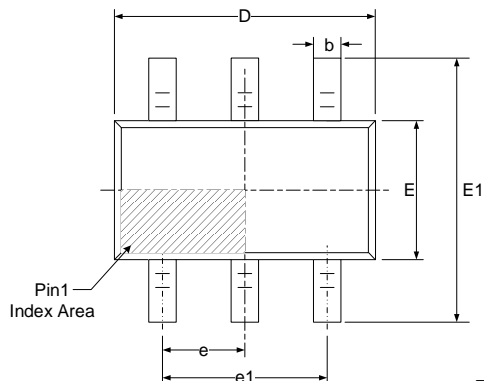

RECOMMENDED LAND PATTERN (Unit: mm)

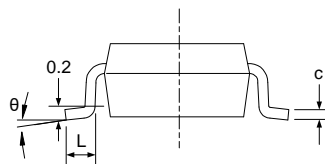
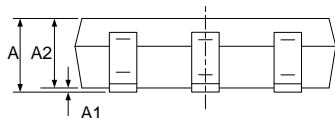

Symbol	Dimensions In Millimeters		Dimensions In Inches	
	Min	Max	Min	Max
A	1.050	1.250	0.041	0.049
A1	0.000	0.100	0.000	0.004
A2	1.050	1.150	0.041	0.045
b	0.300	0.500	0.012	0.020
c	0.100	0.200	0.004	0.008
D	2.820	3.020	0.111	0.119
E	1.500	1.700	0.059	0.067
E1	2.650	2.950	0.104	0.116
e	0.950(BSC)		0.037(BSC)	
e1	1.800	2.000	0.071	0.079
L	0.300	0.600	0.012	0.024
$\theta$	0°	8°	0°	8°

# MSOP-8

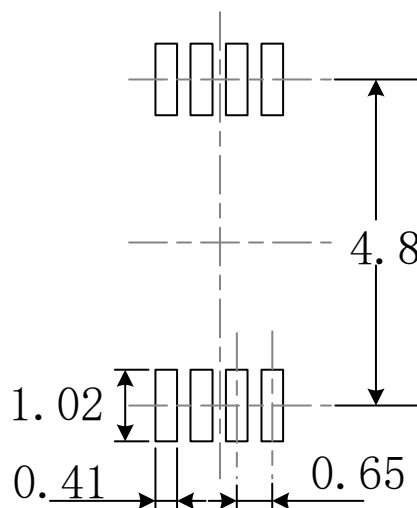
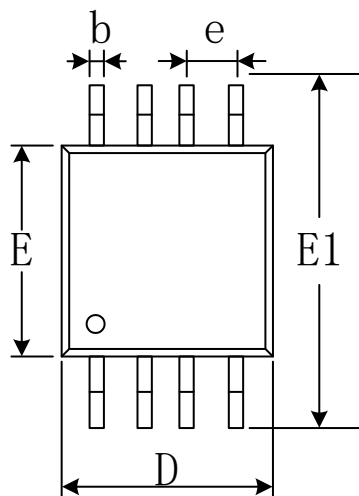

RECOMMENDED LAND PATTERN (Unit: mm)

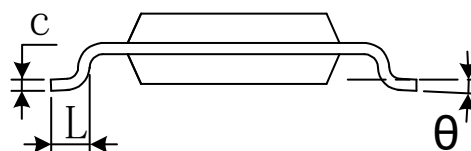
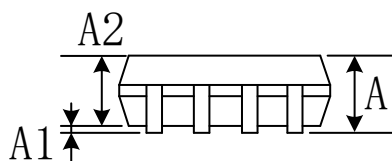

Symbol	Dimensions In Millimeters		Dimensions In Inches	
	Min	Max	Min	Max
A	0.820	1.100	0.032	0.043
A1	0.020	0.150	0.001	0.006
A2	0.750	0.950	0.030	0.037
b	0.250	0.380	0.010	0.015
c	0.090	0.230	0.004	0.009
D	2.900	3.100	0.114	0.122
e	0.650(BSC)		0.026(BSC)	
E	2.900	3.100	0.114	0.122
E1	4.750	5.050	0.187	0.199
L	0.400	0.800	0.016	0.031
$\theta$	0°	6°	0°	6°

# MSOP-10

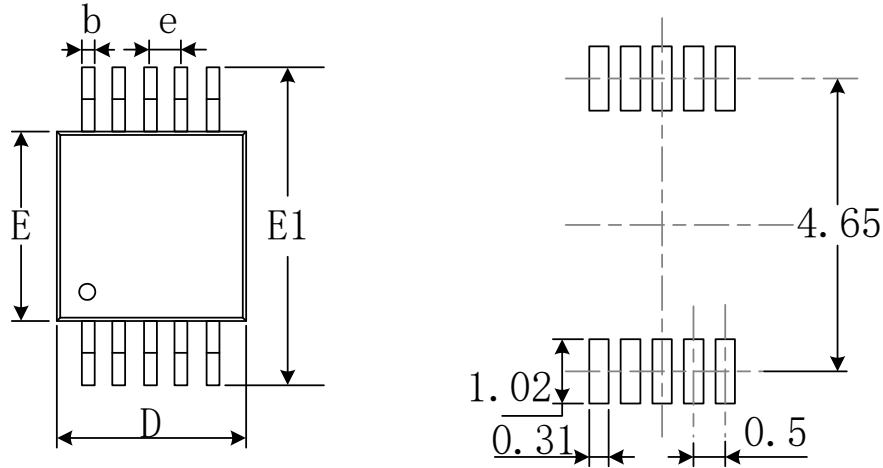

RECOMMENDED LAND PATTERN (Unit: mm)

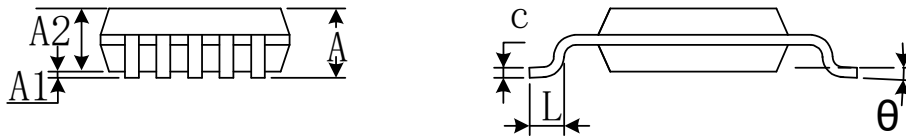

Symbol	Dimensions In Millimeters		Dimensions In Inches	
	Min	Max	Min	Max
A	0.820	1.100	0.032	0.043
A1	0.020	0.150	0.001	0.006
A2	0.750	0.950	0.030	0.037
b	0.180	0.280	0.007	0.011
c	0.090	0.230	0.004	0.009
D	2.900	3.100	0.114	0.122
e	0.50(BSC)		0.020(BSC)	
E	2.900	3.100	0.114	0.122
E1	4.750	5.050	0.187	0.199
L	0.400	0.800	0.016	0.031
θ	0°	6°	0°	6°

# TSSOP-8

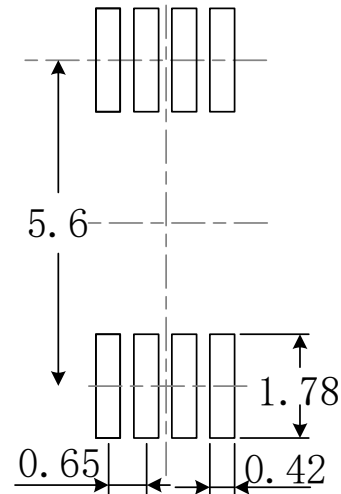
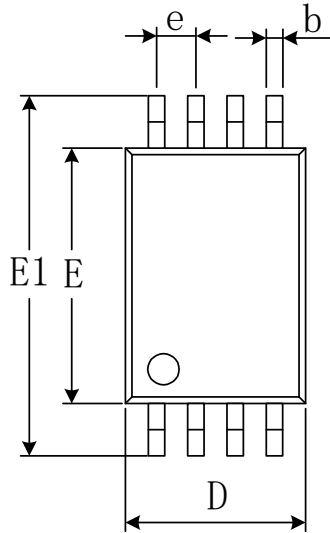

RECOMMENDED LAND PATTERN (Unit: mm)

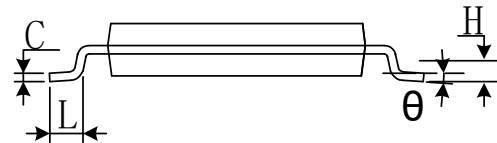
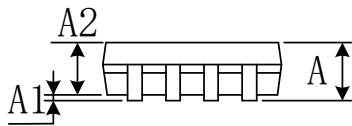

Symbol	Dimensions In Millimeters		Dimensions In Inches	
	Min	Max	Min	Max
A		1.200		0.047
A1	0.050	0.150	0.002	0.006
A2	0.800	1.050	0.031	0.041
b	0.190	0.300	0.007	0.012
c	0.090	0.200	0.004	0.008
D	2.900	3.100	0.114	0.122
E	4.300	4.500	0.169	0.177
E1	6.250	6.550	0.246	0.258
e	0.650(BSC)		0.026(BSC)	
L	0.500	0.700	0.020	0.028
H	0.25(TYP)		0.01(TYP)	
$\theta$	1°	7°	1°	7°

# TSSOP-14

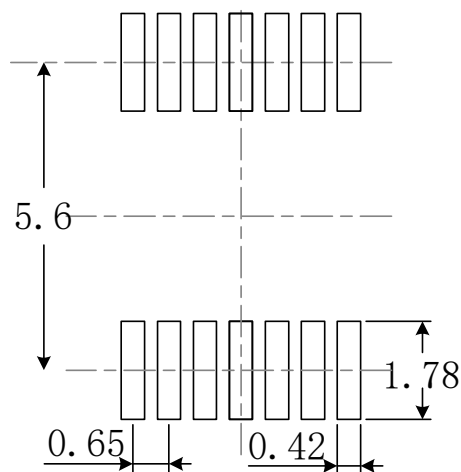
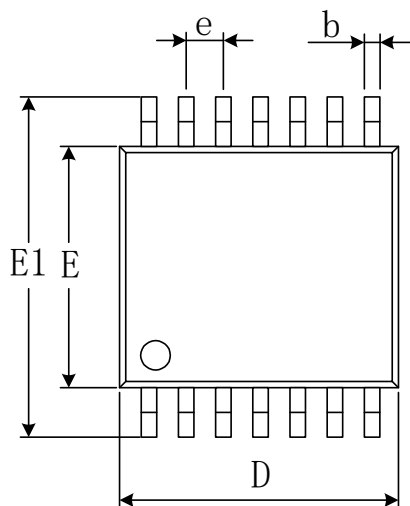

RECOMMENDED LAND PATTERN (Unit: mm)

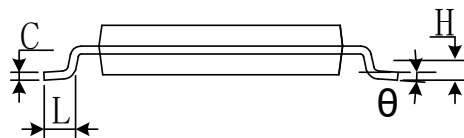
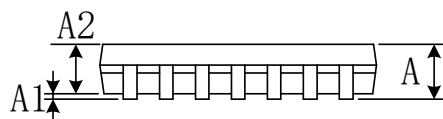

Symbol	Dimensions In Millimeters		Dimensions In Inches	
	Min	Max	Min	Max
A		1.200		0.047
A1	0.050	0.150	0.002	0.006
A2	0.800	1.050	0.031	0.041
b	0.190	0.300	0.007	0.012
c	0.090	0.200	0.004	0.008
D	4.860	5.100	0.191	0.201
E	4.300	4.500	0.169	0.177
E1	6.250	6.550	0.246	0.258
e	0.650(BSC)		0.026(BSC)	
L	0.500	0.700	0.020	0.028
H	0.25(TYP)		0.01(TYP)	
$\theta$	1°	7°	1°	7°

# SOIC-8

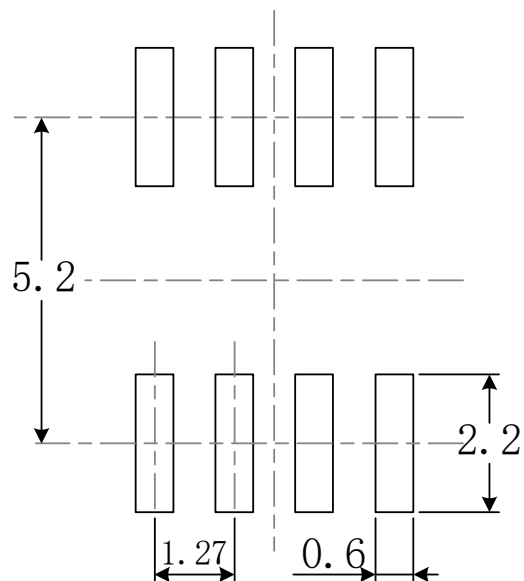
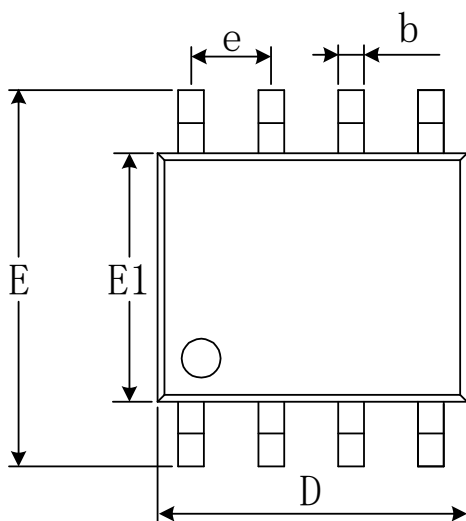

RECOMMENDED LAND PATTERN (Unit: mm)

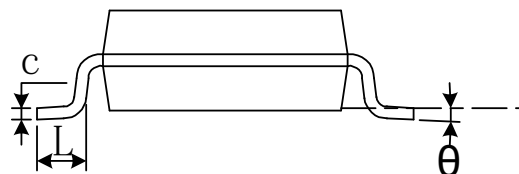
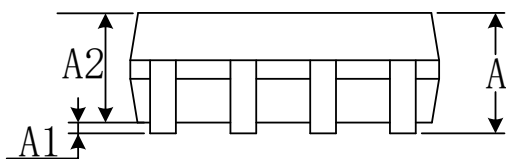

Symbol	Dimensions In Millimeters		Dimensions In Inches	
	Min	Max	Min	Max
A	1.350	1.750	0.053	0.069
A1	0.100	0.250	0.004	0.010
A2	1.350	1.550	0.053	0.061
b	0.330	0.510	0.013	0.020
c	0.170	0.250	0.007	0.010
D	4.800	5.000	0.189	0.197
e	1.270(BSC)		0.050(BSC)	
E	5.800	6.200	0.228	0.244
E1	3.800	4.000	0.150	0.157
L	0.400	1.270	0.016	0.050
$\theta$	0°	8°	0°	8°

# SOIC-14

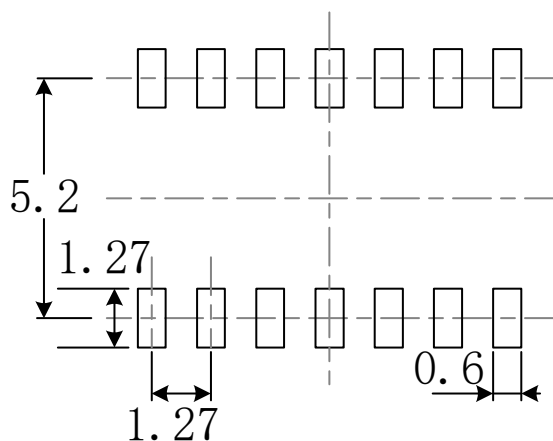
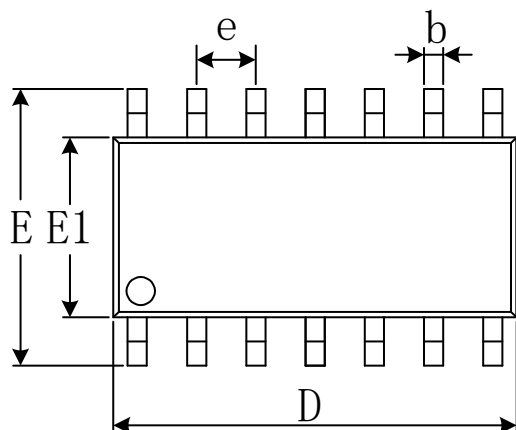

RECOMMENDED LAND PATTERN (Unit: mm)

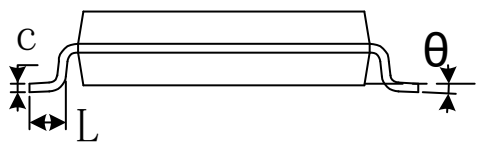
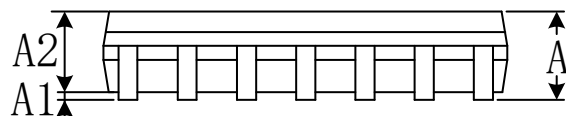

Symbol	Dimensions In Millimeters		Dimensions In Inches	
	Min	Max	Min	Max
A	1.350	1.750	0.053	0.069
A1	0.100	0.250	0.004	0.010
A2	1.350	1.550	0.053	0.061
b	0.310	0.510	0.012	0.020
c	0.100	0.250	0.004	0.010
D	8.450	8.850	0.333	0.348
e	1.270(BSC)		0.050(BSC)	
E	5.800	6.200	0.228	0.244
E1	3.800	4.000	0.150	0.157
L	0.400	1.270	0.016	0.050
$\theta$	0°	8°	0°	8°

# TDFN-2x2-8L

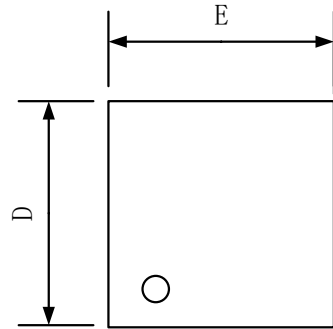

TOP VIEW

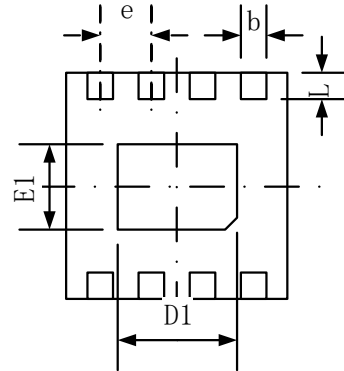

BOTTOM VIEW

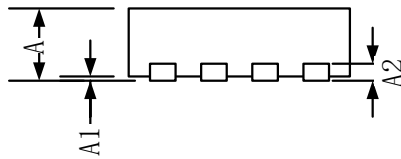

SIDE VIEW

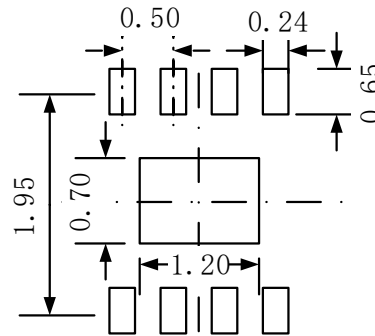

RECOMMENDED LAND  
PATTERN (Unit: mm)

Symbol	Dimensions In Millimeters		Dimensions In Inches	
	Min	Max	Min	Max
A	0.700	0.800	0.028	0.031
A1	0.000	0.050	0.000	0.002
A2	0.203(TYP)		0.008(TYP)	
b	0.180	0.300	0.007	0.012
D	1.900	2.100	0.075	0.083
D1	1.100	1.300	0.043	0.051
E	1.900	2.100	0.075	0.083
E1	0.600	0.800	0.024	0.031
e	0.500(TYP)		0.020(TYP)	
L	0.250	0.450	0.010	0.018



# TDFN-3x3-8L

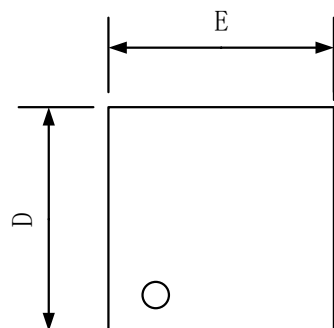

TOP VIEW

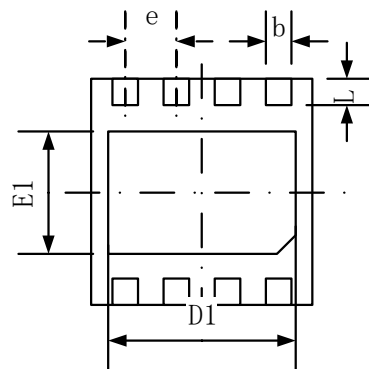

BOTTOM VIEW

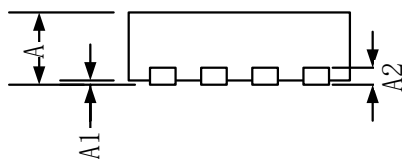

SIDE VIEW

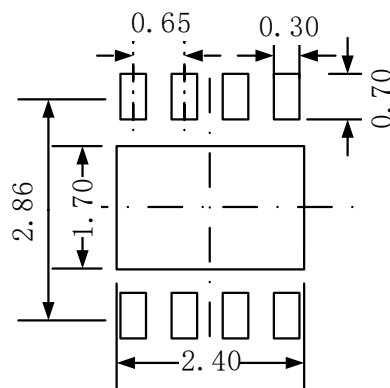

RECOMMENDED LAND PATTERN (Unit: mm)

Symbol	Dimensions In Millimeters		Dimensions In Inches	
	Min	Max	Min	Max
A	0.700	0.800	0.028	0.031
A1	0.000	0.050	0.000	0.002
A2	0.203		0.008	
b	0.250	0.350	0.010	0.014
D	2.900	3.100	0.114	0.122
D1	2.350	2.450	0.093	0.096
E	2.900	3.100	0.114	0.122
E1	1.650	1.750	0.065	0.069
e	0.650 TYP		0.026 TYP	
L	0.370	0.470	0.015	0.019

# TDFN-3x2-14L

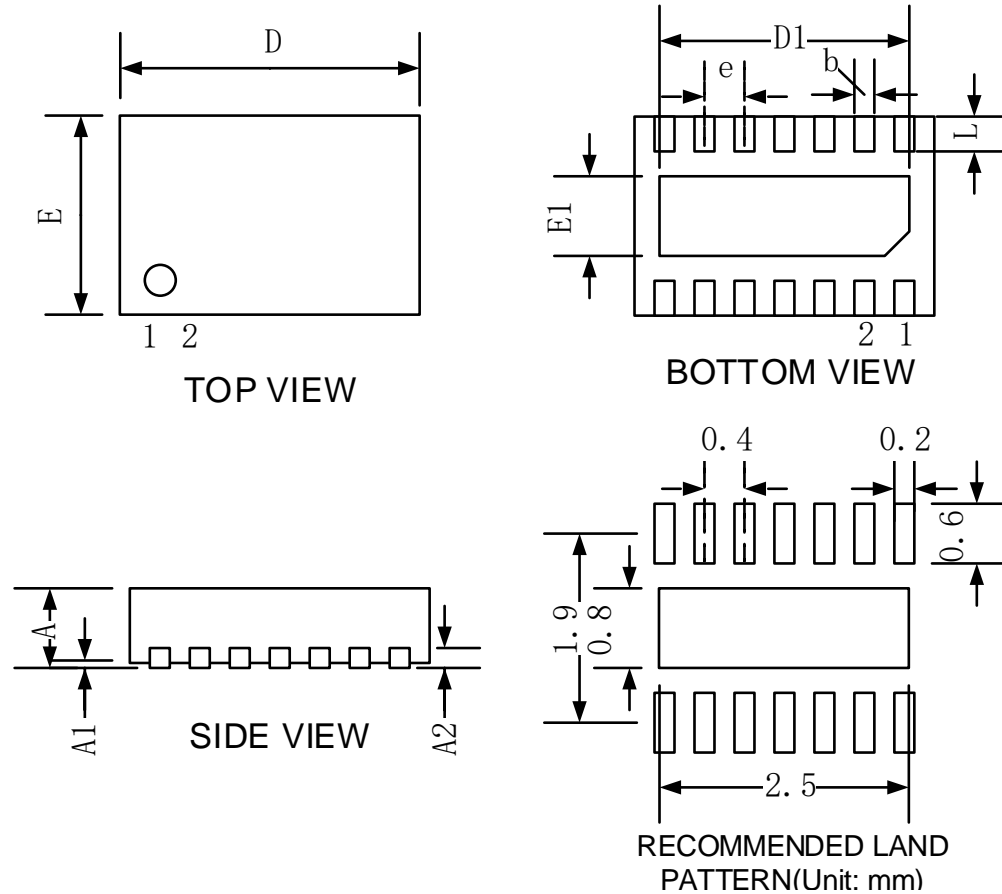

Symbol	Dimensions In Millimeters		Dimensions In Inches	
	Min	Max	Min	Max
A	0.700	0.800	0.028	0.031
A1	0.000	0.050	0.000	0.002
A2	0.200		0.008	
b	0.150	0.250	0.006	0.010
D	2.900	3.100	0.114	0.122
D1	2.400	2.600	0.094	0.102
E	1.900	2.100	0.075	0.083
E1	0.700	0.900	0.028	0.035
e	0.400 TYP		0.016 TYP	
L	0.300	0.400	0.012	0.016

## X-ON Electronics

Largest Supplier of Electrical and Electronic Components

*Click to view similar products for [Operational Amplifiers - Op Amps](#) category:*

*Click to view products by [RUNIC](#) manufacturer:*

Other Similar products are found below :

[430227FB](#) [AZV831KTR-G1](#) [UPC451G2-A](#) [UPC824G2-A](#) [LT1678IS8](#) [042225DB](#) [058184EB](#) [UPC822G2-A](#) [UPC258G2-A](#)  
[NCS5651MNTXG](#) [NCV33202DMR2G](#) [NJM324E](#) [NTE925](#) [5962-9080901MCA\\*](#) [AP4310AUMTR-AG1](#) [HA1630D02MMEL-E](#)  
[HA1630S01LPEL-E](#) [SCY33178DR2G](#) [NJU77806F3-TE1](#) [NCV5652MUTWG](#) [NCV20034DR2G](#) [LM2902EDR2G](#) [NTE778S](#) [NTE871](#)  
[NTE924](#) [NTE937](#) [MCP6V16UT-E/OT](#) [MCP6V17T-E/MS](#) [MCP6V19T-E/ST](#) [SCY6358ADR2G](#) [LTC2065IUD#PBF](#) [NCS20282FCTTAG](#)  
[LM4565FVT-GE2](#) [EL5420CRZ-T7A](#) [TSV791IYLT](#) [TSV772IQ2T](#) [TLV2772QPWR](#) [NJM2100M-TE1](#) [NJM4556AM-TE1](#) [MCP6487-E/SN](#)  
[MCP6487-E/MS](#) [AS324MTR-E1](#) [AS358MMTR-G1](#) [MCP6232T-EMNY](#) [MCP662-E/MF](#) [TLC081AIP](#) [TLC082AIP](#) [TLE2074ACDW](#)  
[TLV07IDR](#) [TLV2170IDGKT](#)