

150mA, Low Power Consumption, High Voltage CMOS LDO Regulator

FEATURES

- **Low Quiescent Current I_Q :
2 μ A Typical at Light Loads**
- **150mA Nominal Output Current**
- **Low Dropout Voltage**
- **Low Temperature Coefficient**
- **High Input Voltage (up to 36V)**
- **Output Voltage Accuracy: $\pm 2\%$**
- **Fixed 2.5V、3.0V、3.3V、3.6V、
and 5.0V Output Voltage**
- **Over temperature Protection**
- **Short Circuit Protection**
- **Micro SIZE PACKAGES: SOT23-3 and
SOT89-3L**

APPLICATIONS

- **Audio/Video Equipment**
- **Communication Equipment**
- **Battery-Powered Equipment**
- **Automotive Head Unit**
- **Laptop, Palmtops, Notebook Computers**

DESCRIPTION

The RS75xx-1 series is a set of low power high voltage regulators implemented in CMOS technology. Which can provide 150mA output current. The device allows input voltage as high as 36V. It is very suitable for multi-cell battery systems, bus voltage power supply systems and other high DC voltage systems. Wide input voltage can make it well withstand the impact of surge voltage and ensure the stability of output voltage.

The RS75xx-1 series only 2 μ A (typical) current is consumed by itself, which is especially important in multi-battery power supply systems and can reduce the standby power consumption of the whole system .

The RS75xx-1 is available in Green SOT23-3 and SOT89-3L packages. The over temperature is 150°C.

Device Information (1)

| PART NUMBER | PACKAGE | BODY SIZE (NOM) |
|-------------|-------------|-----------------|
| RS75xx-1 | SOT23-3(3) | 1.60mm×2.92mm |
| | SOT89-3L(3) | 2.45mm×4.50mm |

(1) For all available packages, see the orderable addendum at the end of the data sheet.

Typical Application Schematic

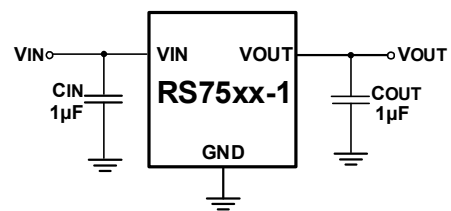

Pin Configuration and Functions (Top View)

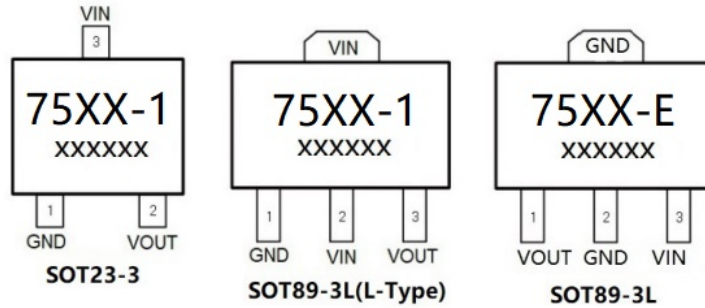

PIN DESCRIPTION

| NAME | PIN | | | FUNCTION |
|------|---------|----------------------|----------|--|
| | SOT23-3 | SOT89-3L (L-Type) | SOT89-3L | |
| GND | 1 | 1 | 2 | Ground. |
| VOUT | 2 | 3 | 1 | Regulator Output. Recommended output capacitor range: 1 μ F to 10 μ F. |
| VIN | 3 | 2 | 3 | Regulator Input. Up to 36V input voltage. At least 1 μ F supply bypass capacitor is recommended. |

PACKAGE/ORDERING INFORMATION

| PRODUCT | ORDERING NUMBER | V _{OUT} (V) | PACKAGE LEAD | PACKAGE MARKING | PACKAGE OPTION |
|----------|-----------------|----------------------|------------------|-----------------|--------------------|
| RS7525-1 | RS7525-1YF3 | 2.5 | SOT23-3 | 7525-1 | Tape and Reel,3000 |
| | RS7525-1YE3L | 2.5 | SOT89-3L(L-Type) | 7525-1 | Tape and Reel,1000 |
| RS7530-1 | RS7530-1YF3 | 3.0 | SOT23-3 | 7530-1 | Tape and Reel,3000 |
| | RS7530-1YE3L | 3.0 | SOT89-3L(L-Type) | 7530-1 | Tape and Reel,1000 |
| RS7533-1 | RS7533-1YF3 | 3.3 | SOT23-3 | 7533-1 | Tape and Reel,3000 |
| | RS7533-1YE3 | 3.3 | SOT89-3L | 7533-E | Tape and Reel,1000 |
| | RS7533-1YE3L | 3.3 | SOT89-3L(L-Type) | 7533-1 | Tape and Reel,1000 |
| RS7536-1 | RS7536-1YF3 | 3.6 | SOT23-3 | 7536-1 | Tape and Reel,3000 |
| | RS7536-1YE3L | 3.6 | SOT89-3L(L-Type) | 7536-1 | Tape and Reel,1000 |
| RS7550-1 | RS7550-1YF3 | 5.0 | SOT23-3 | 7550-1 | Tape and Reel,3000 |
| | RS7550-1YE3 | 5.0 | SOT89-3L | 7550-E | Tape and Reel,1000 |
| | RS7550-1YE3L | 5.0 | SOT89-3L(L-Type) | 7550-1 | Tape and Reel,1000 |

NOTE:

1.Date Code and Vendor Code also marking in package.

Specifications

Absolute Maximum Ratings

over operating free-air temperature range (unless otherwise noted) ⁽¹⁾⁽²⁾

| | | MIN | MAX | UNIT |
|------------------|---|--------------------|-----|------|
| V _{IN} | Input voltage | -0.3 | 40 | V |
| T _J | Junction temperature | -40 | 150 | °C |
| P _D | Continuous power dissipation ⁽³⁾ | Internally Limited | | W |
| T _{stg} | Storage temperature | -65 | 150 | °C |

(1) Stresses beyond those listed under *Absolute Maximum Ratings* may cause permanent damage to the device. These are stress ratings only, and functional operation of the device at these or any other conditions beyond those indicated under *Recommended Operating Conditions* is not implied. Exposure to absolute-maximum-rated conditions for extended periods may affect device reliability.

(2) All voltages are with respect to the GND pin.

(3) Internal thermal shutdown circuitry protects the device from permanent damage.

ESD Ratings

| | | VALUE | UNIT | |
|--------------------|-------------------------|------------------------|-------|---|
| V _(ESD) | Electrostatic discharge | Human-body model (HBM) | ±4000 | V |
| | | Machine model (MM) | ±100 | V |

Recommended Operating Conditions

over operating free-air temperature range (unless otherwise noted) ⁽¹⁾

| | | MIN | MAX | UNIT |
|------------------|-----------------------------------|-----|--------------------|------|
| V _{IN} | Input supply voltage | 2.5 | 36 | V |
| I _{OUT} | Output current | 0 | 150 | mA |
| C _{OUT} | Capacitor of V _{out} pin | 1 | 22 | μF |
| T _A | Operating temperature | -40 | +85 ⁽²⁾ | °C |

(1) All voltages are with respect to the GND pin

(2) The chip's operating temperature is determined by the junction temperature(T_J), the relationship between T_A and T_J, Please refer to the application note as below.

Thermal Information

| THERMAL METRIC (1) | | RS75xx-1 | | | UNIT |
|-----------------------|--|----------------------|----------|---------|------|
| | | SOT89-3L (L-Type) | SOT89-3L | SOT23-3 | |
| | | 3 PINS | 3 PINS | 3 PINS | |
| R _{θJA} | Junction-to-ambient thermal resistance | 165 | 75 | 185.6 | °C/W |
| R _{θJC(top)} | Junction-to-case (top) thermal resistance | 88.5 | 88.1 | 104.3 | °C/W |
| R _{θJB} | Junction-to-board thermal resistance | 39.6 | 9.6 | 54.5 | °C/W |
| ψ _{JT} | Junction-to-top characterization parameter | 26.5 | 6.2 | 31.0 | °C/W |
| ψ _{JB} | Junction-to-board characterization parameter | 49.7 | 9.7 | 54.5 | °C/W |
| R _{JC(bot)} | Junction-to-case (bottom) thermal resistance | 77.7 | 7.7 | N/A | °C/W |

ELECTRICAL CHARACTERISTICS

($V_{IN} = V_{OUT} + 2V$, $C_{IN} = C_{OUT} = 1\mu F$, $V_{OUT} = 3.3V$, Full = $-40^{\circ}C$ to $+85^{\circ}C$, typical values are at $T_A = +25^{\circ}C$, unless otherwise noted.)

| PARAMETER | SYMBOL | CONDITIONS | TEMP | MIN | TYP | MAX | UNITS |
|---|---|---|----------------|-----|------|-----|------------------|
| Input Voltage ⁽¹⁾ | V_{IN} | $V_{OUT} = 3.3V$ | $+25^{\circ}C$ | - | - | 36 | V |
| Output Voltage Accuracy | | $I_{OUT} = 10mA$ | $+25^{\circ}C$ | -2 | 0 | 2 | % |
| Ground Pin Current | | No load | $+25^{\circ}C$ | - | 2 | 3 | μA |
| Maximum Output Current ⁽²⁾ | | | $+25^{\circ}C$ | 70 | 100 | - | mA |
| Dropout Voltage ⁽³⁾ | V_{DROP} | $I_{OUT} = 100mA$, $\Delta V_O = 2\%$ | $+25^{\circ}C$ | - | 526 | 800 | mV |
| Line Regulation | $\frac{\Delta V_{OUT}}{\Delta V_{IN} \times V_{OUT}}$ | $V_{IN} = V_{OUT} + 2V$ to $36V$, $I_{OUT} = 1mA$ | $+25^{\circ}C$ | | 0.05 | 0.2 | %/V |
| Load Regulation | ΔV_{OUT} | $V_{IN} = V_{OUT} + 2V$, $I_{OUT} = 1mA$ to $50mA$ | $+25^{\circ}C$ | | 25 | 60 | mV |
| Power Supply Rejection Ratio | PSRR | $V_{OUT} = 3.3V$, $I_{OUT} = 10mA$ | $+25^{\circ}C$ | | 58 | | dB |
| | | | | | 40 | | |
| Output Voltage Temperature Coefficient ⁽⁴⁾ | $\frac{\Delta V_{OUT}}{\Delta T_A \times V_{OUT}}$ | $I_{OUT} = 1mA$ | FULL | | 100 | | ppm/ $^{\circ}C$ |
| THERMAL PROTECTION | | | | | | | |
| Thermal Shutdown Temperature | T_{SHDN} | | | | 150 | | $^{\circ}C$ |

NOTES:

1. $V_{IN} \geq V_{OUT (NOMINAL)}$, whichever is greater.

2 Maximum output current is affected by the PCB layout, size of metal trace, the thermal conduction path between metal layers, ambient temperature and the other environment factors of system. Attention should be paid to the dropout voltage when $V_{IN} < V_{OUT} + V_{DROP}$.

3. The dropout voltage is defined as $V_{IN} - V_{OUT}$, when V_{OUT} is 100mV below the value of V_{OUT} for $V_{IN} = V_{OUT (NOMINAL)} + 2V$.

4. Output voltage temperature coefficient is defined as the worst-case voltage change divided by the total temperature range.

ELECTRICAL CHARACTERISTICS

($V_{IN} = V_{OUT} + 2V$, $C_{IN} = C_{OUT} = 1\mu F$, $V_{OUT} = 5.0V$, Full = $-40^{\circ}C$ to $+85^{\circ}C$, typical values are at $T_A = +25^{\circ}C$, unless otherwise noted.)

| PARAMETER | SYMBOL | CONDITIONS | TEMP | MIN | TYP | MAX | UNITS |
|---|---|--|----------------|-----|------|-----|------------------|
| Input Voltage ⁽¹⁾ | V_{IN} | $V_{OUT} = 5.0V$ | $+25^{\circ}C$ | - | - | 36 | V |
| Output Voltage Accuracy | | $I_{OUT} = 10mA$ | $+25^{\circ}C$ | -2 | 0 | 2 | % |
| Ground Pin Current | | No load $V_{IN} = V_{OUT} + 2V$ | $+25^{\circ}C$ | - | 2 | 3 | μA |
| Maximum Output Current ⁽²⁾ | | | $+25^{\circ}C$ | 100 | 150 | - | mA |
| Dropout Voltage ⁽³⁾ | V_{DROP} | $I_{OUT} = 100mA$ $\Delta V_o = 2\%$ | $+25^{\circ}C$ | - | 440 | 700 | mV |
| Line Regulation | $\frac{\Delta V_{OUT}}{\Delta V_{IN} \times V_{OUT}}$ | $V_{IN} = V_{OUT} + 2V$ to 36V, $I_{OUT} = 1mA$ | $+25^{\circ}C$ | | 0.05 | 0.2 | %/V |
| Load Regulation | ΔV_{OUT} | $V_{IN} = V_{OUT} + 2V$, $I_{OUT} = 1mA$ to 150mA | $+25^{\circ}C$ | | 25 | 60 | mV |
| Power Supply Rejection Ratio | PSRR | $V_{OUT} = 5.0V$, $I_{OUT} = 10mA$ | $+25^{\circ}C$ | | 58 | | dB |
| | | $f = 217Hz$ $f = 1KHz$ | | | 40 | | |
| Output Voltage Temperature Coefficient ⁽⁴⁾ | $\frac{\Delta V_{OUT}}{\Delta T_A \times V_{OUT}}$ | $I_{OUT} = 1mA$ | FULL | | 100 | | ppm/ $^{\circ}C$ |
| THERMAL PROTECTION | | | | | | | |
| Thermal Shutdown Temperature | T_{SHDN} | | | | 150 | | $^{\circ}C$ |

NOTES:

- $V_{IN} \geq V_{OUT (NOMINAL)}$, whichever is greater.
- Maximum output current is affected by the PCB layout, size of metal trace, the thermal conduction path between metal layers, ambient temperature and the other environment factors of system. Attention should be paid to the dropout voltage when $V_{IN} < V_{OUT} + V_{DROP}$.
- The dropout voltage is defined as $V_{IN} - V_{OUT}$, when V_{OUT} is 100mV below the value of V_{OUT} for $V_{IN} = V_{OUT (NOMINAL)} + 2V$.
- Output voltage temperature coefficient is defined as the worst-case voltage change divided by the total temperature range.

TYPICAL CHARACTERISTICS

$V_{IN} = 5.3V$, $V_{OUT} = 3.0V$, $C_{IN} = C_{OUT} = 1\mu F$, $T_A = 25^\circ C$ unless otherwise noted.

Line-Transient Response

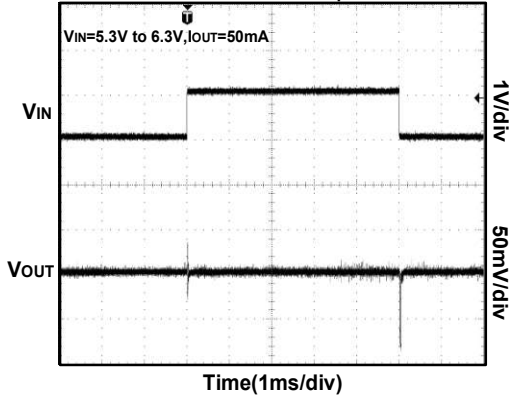

Load-Transient Response

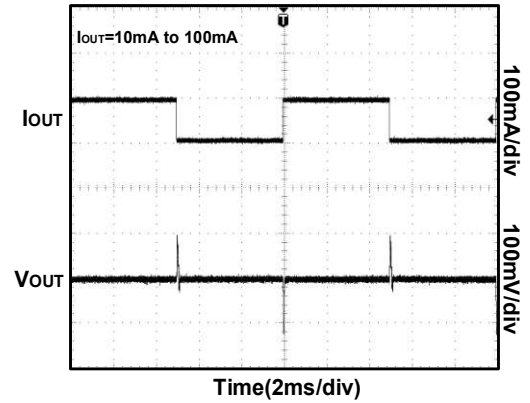

Power-Up/Power-Down Output Waveform

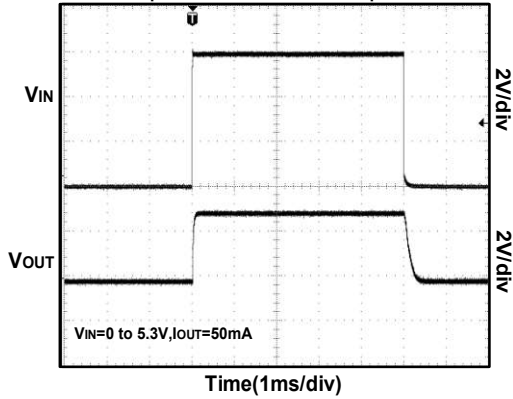

Output Short Waveform

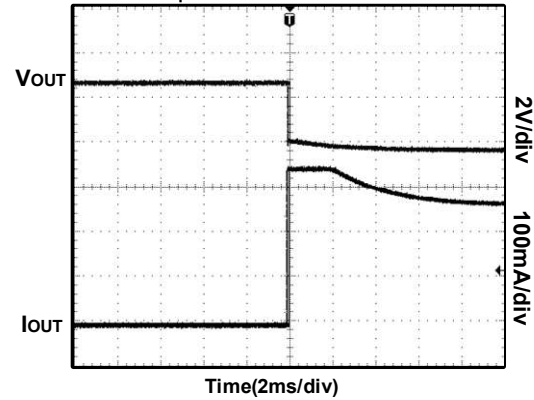

Dropout Voltage vs. Temperature

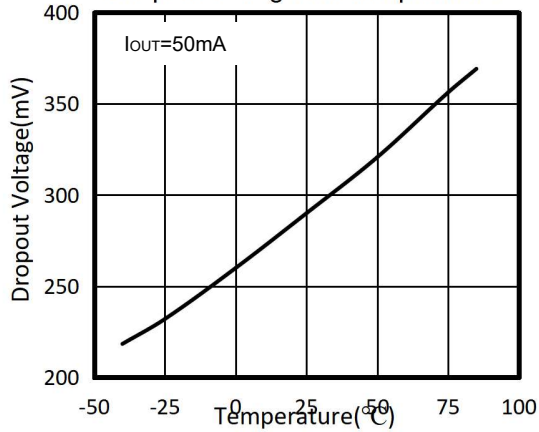

Dropout Voltage vs. Output Current

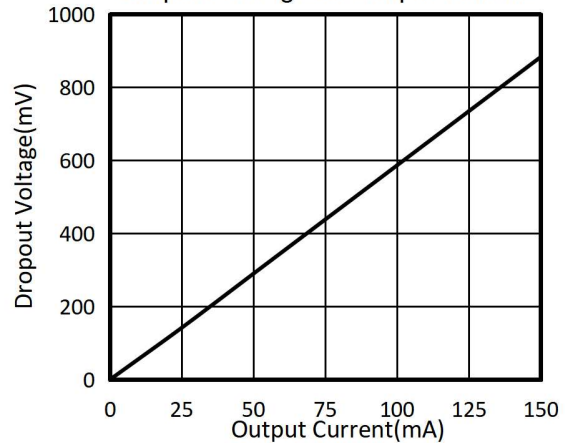

TYPICAL CHARACTERISTICS

$V_{IN} = 5.3V$, $V_{OUT} = 3.0V$, $C_{IN} = C_{OUT} = 1\mu F$, $T_A = 25^\circ C$ unless otherwise noted.

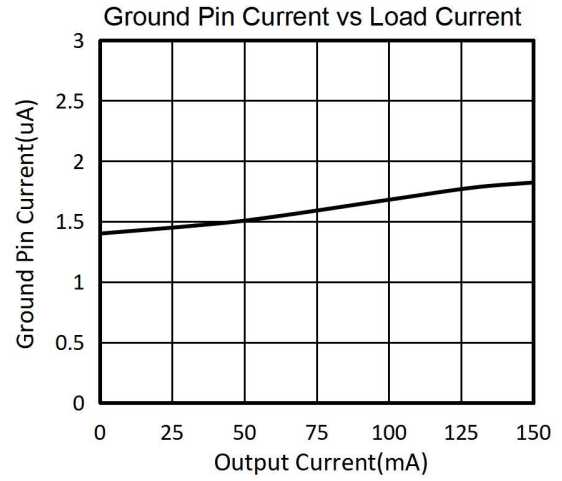
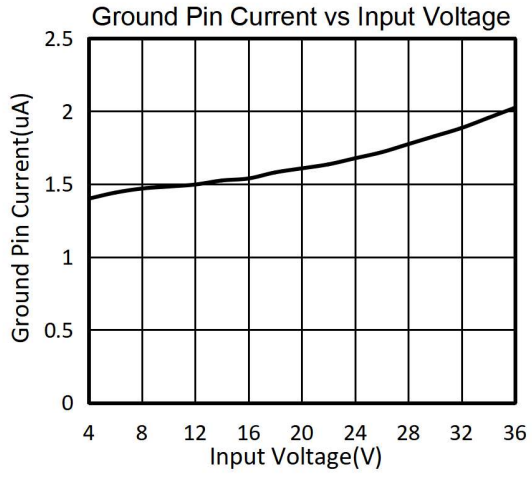

DETAILED DESCRIPTION

Overview

The RS75xx-1 low-dropout regulators (LDO) consumes only 2μA of quiescent current at light load and delivers excellent line and load transient performance. These characteristics, combined with low noise and good PSRR with low dropout voltage, make this device ideal for portable consumer applications.

Functional Block Diagram

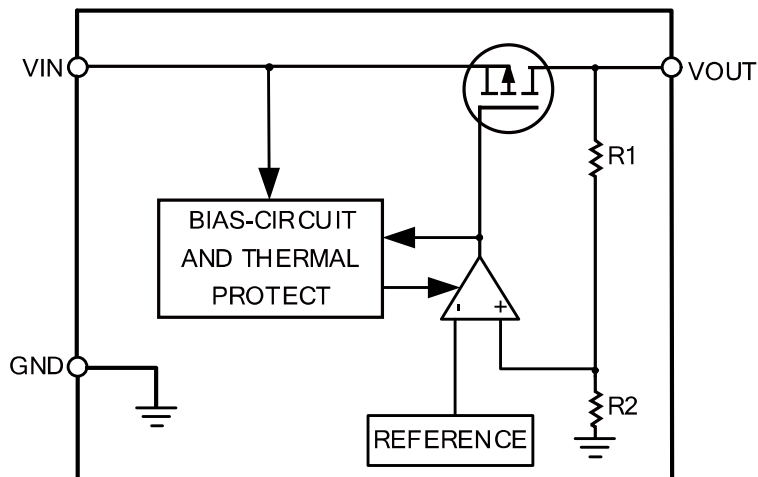

Thermal Considerations

When the junction temperature is too high, the thermal protection circuitry sends a signal to the control logic that will shut down the IC. The IC will restart when the temperature has sufficiently cooled down. The maximum power dissipation is dependent on the thermal resistance of the case and the circuit board, the temperature difference between the die junction and the ambient air, and the rate of air flow. The GND pin must be connected to the ground plane for proper dissipation.

Applications Note:

- 1) The phase compensation circuit and ESR of the output capacitor are used inside the circuit to compensate, so a capacitor larger than 1.0μF must be connected to the ground.
- 2) It is recommended to use 1μF polar capacitors for input and output, and to keep the capacitors as close to the VIN and VOUT pins of LDO as possible.
- 3) Pay attention to the use conditions of input and output voltages and load currents to avoid the power consumption (PD) inside the IC exceeding the maximum power consumption allowed by the package.

$$PD = (V_{IN} - V_{OUT}) \times I_{OUT}$$

$$T_{PN} = PD \times R_{\theta JA} + T$$

T_{PN} is junction temperature

T is ambient temperature.

- 4) When the input voltage V_{IN} is greater than 2.5V, if V_{IN} is also higher than the output set value plus the device dropout voltage, V_{OUT} is equal to the set value. Otherwise, V_{OUT} is equal to V_{IN} minus the dropout voltage. If V_{IN} lower than 2.5V, the V_{OUT} is:

$$V_{OUT} = V_{IN} - V_{Dropout}$$

PACKAGE OUTLINE DIMENSIONS

SOT23-3

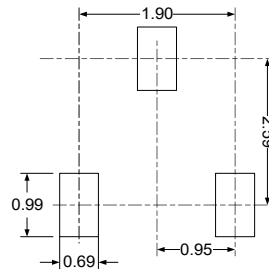
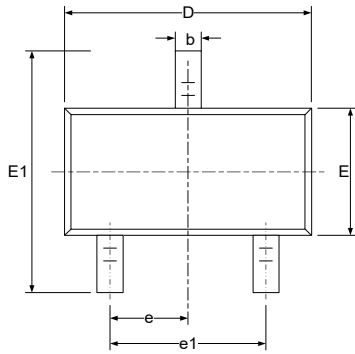
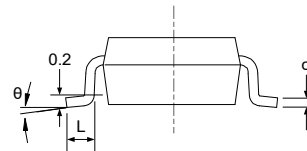
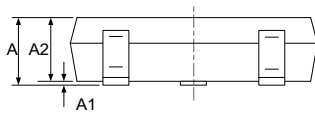
RECOMMENDED LAND PATTERN (Unit: mm)

| Symbol | Dimensions In Millimeters | | Dimensions In Inches | |
|----------|---------------------------|-------|----------------------|-------|
| | Min | Max | Min | Max |
| A | 1.050 | 1.250 | 0.041 | 0.049 |
| A1 | 0.000 | 0.100 | 0.000 | 0.004 |
| A2 | 1.050 | 1.150 | 0.041 | 0.045 |
| b | 0.300 | 0.500 | 0.012 | 0.020 |
| c | 0.100 | 0.200 | 0.004 | 0.008 |
| D | 2.820 | 3.020 | 0.111 | 0.119 |
| E | 1.500 | 1.700 | 0.059 | 0.067 |
| E1 | 2.650 | 2.950 | 0.104 | 0.116 |
| e | 0.950(BSC) | | 0.037(BSC) | |
| e1 | 1.800 | 2.000 | 0.071 | 0.079 |
| L | 0.300 | 0.600 | 0.012 | 0.024 |
| θ | 0° | 8° | 0° | 8° |

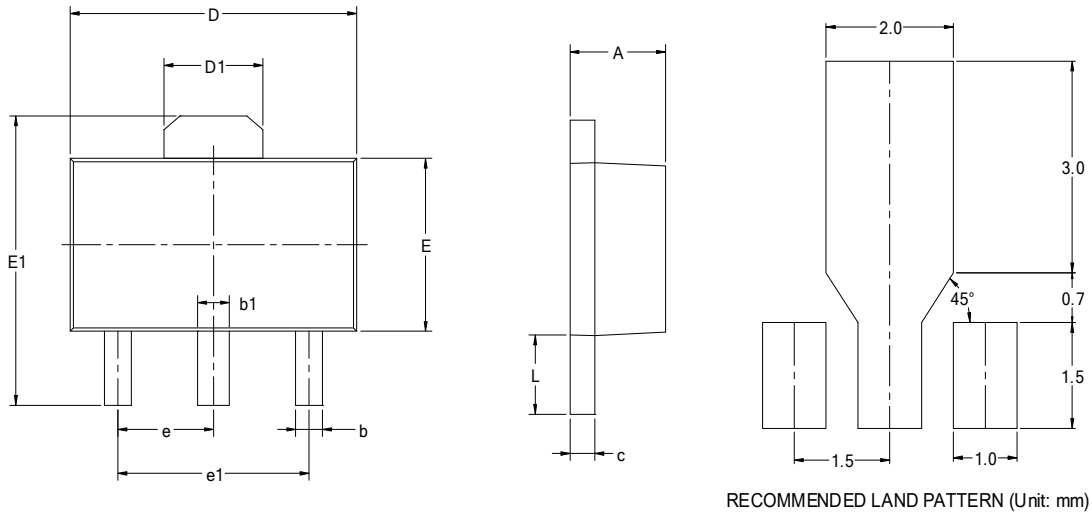
SOT89-3L

| Symbol | Dimensions In Millimeters | | Dimensions In Inches | |
|--------|---------------------------|-------|----------------------|-------|
| | Min | Max | Min | Max |
| A | 1.400 | 1.600 | 0.055 | 0.063 |
| b | 0.320 | 0.520 | 0.013 | 0.020 |
| b1 | 0.400 | 0.580 | 0.016 | 0.023 |
| c | 0.350 | 0.440 | 0.014 | 0.017 |
| D | 4.400 | 4.600 | 0.173 | 0.181 |
| D1 | 1.550 REF | | 0.061 REF | |
| E | 2.300 | 2.600 | 0.091 | 0.102 |
| E1 | 3.940 | 4.250 | 0.155 | 0.167 |
| e | 1.500 BSC | | 0.060 BSC | |
| e1 | 3.000 BSC | | 0.118 BSC | |
| L | 0.900 | 1.200 | 0.035 | 0.047 |

X-ON Electronics

Largest Supplier of Electrical and Electronic Components

Click to view similar products for [Linear Voltage Regulators](#) category:

Click to view products by [RUNIC](#) manufacturer:

Other Similar products are found below :

[LV5684PVD-XH](#) [MCDTSA6-2R](#) [L7815ACV-DG](#) [LV56801P-E](#) [UA7805CKC](#) [714954EB](#) [ZMR500QFTA](#) [BA033LBSG2-TR](#)

[NCV78M05ABDTRKG](#) [LV5680P-E](#) [L79M05T-E](#) [L78LR05D-MA-E](#) [NCV317MBTG](#) [NTE7227](#) [MP2018GZD-33-P](#) [MP2018GZD-5-P](#)

[LV5680NPVC-XH](#) [ZTS6538SE](#) [UA78L09CLP](#) [UA78L09CLPR](#) [CAT6221-PPTD-GT3](#) [MC78M09CDTRK](#) [NCV51190MNTAG](#)

[BL1118CS8TR1833](#) [BL8563CKETR18](#) [BL8077CKETR33](#) [BL9153-33CC3TR](#) [BL9161G-15BADRN](#) [BL9161G-28BADRN](#)

[BRCO7530MMC](#) [CJ7815B-TFN-ARG](#) [LM317C](#) [GM7333K](#) [GM7350K](#) [XC6206P332MR](#) [HT7533](#) [LM7912S/TR](#) [LT1764S/TR](#) [LM7805T](#)

[LM338T](#) [LM1117IMP-3.3/TR](#) [HT1117AM-3.3](#) [HT7550S](#) [AMS1117-3.3](#) [HT7150S](#) [78L12](#) [HT7550](#) [HT7533-1](#) [HXY6206I-2.5](#) [HT7133](#)