

Supply Voltage Supervisor with Reset Circuits

1 FEATURES

- **Operating Voltage Range: 1.0V to 5.5V**
- **Low Power Consumption: 40μA (Max)**
- **Precision Supply-Voltage Monitor:**
2.63V, 2.93V, 3.08V, 4.00V, 4.65V
- **Guaranteed $\overline{\text{RESET}}$ Valid at $V_{CC}= 1.0V$**
- **200ms Reset Pulse Width**
- **Voltage Monitor for Power-Fail or Low-Battery Warning**
- **Operating Temperature Range:**
-40°C to +125°C
- **Push-pull, $\overline{\text{RESET}}$ Output**
- **Available in Green Package: SOT23**

2 APPLICATIONS

- **Computers**
- **SOC , DSP or Micro controllers**
- **Embedded Systems**
- **Industrial Equipment**
- **Intelligent Instruments**
- **Critical μP Power Monitoring**
- **Wireless Communications Systems**

3 DESCRIPTIONS

The RS809 microprocessor (μP) supervisory circuits reduce the complexity and number of components required to monitor power-supply and battery function in μP systems. This device significantly improves system reliability and accuracy compared to separate ICs or discrete components.

These circuits perform a single function: they assert a reset signal whenever the V_{CC} supply voltage declines below a preset threshold, keeping it asserted for at least 200ms after V_{CC} has risen above the reset threshold. Reset thresholds suitable for operation with a variety of supply voltages are available.

The RS809 have push-pull outputs. The RS809 have an active-low $\overline{\text{RESET}}$ output. The reset comparator is designed to ignore fast transients on V_{CC} , and the outputs are guaranteed to be in the correct logic state for V_{CC} down to 1.0V.

Low supply current makes the RS809 ideal for use in portable equipment. The RS809 is available in Green SOT23 package. It operates over an ambient temperature range of -40°C to +125°C.

Device Information (1)

PART NUMBER	PACKAGE	BODY SIZE (NOM)
RS809	SOT23(3)	1.30mm×2.92mm

(1) For all available packages, see the orderable addendum at the end of the data sheet.

4 TYPICAL APPLICATION

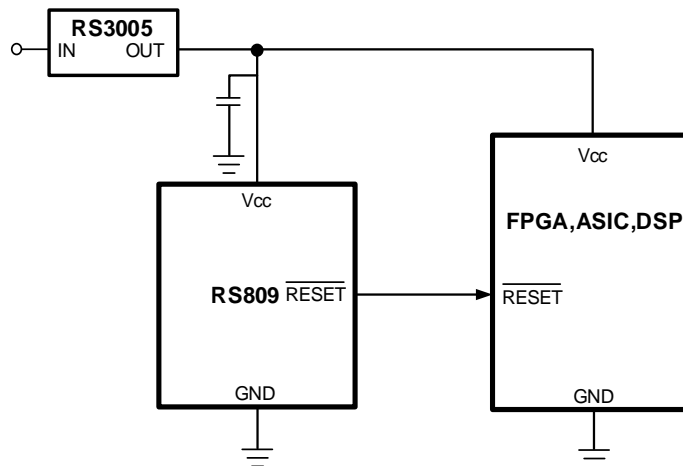

Table of Contents

1 FEATURES	1
2 APPLICATIONS	1
3 DESCRIPTIONS	1
4 TYPICAL APPLICATION	1
5 Revision History	3
6 PACKAGE/ORDERING INFORMATION ⁽¹⁾	4
7 PIN CONFIGURATIONS	5
8 SPECIFICATIONS	6
8.1 Absolute Maximum Ratings ⁽¹⁾	6
8.2 ESD Ratings	6
8.3 Thermal Information:	6
8.4 ELECTRICAL CHARACTERISTICS	7
8.5 TYPICAL OPERATING CHARACTERISTICS	8
9 Function Block Diagram	10
10 Detailed Description	10
11 Application and Implementation	11
11.1 Ensuring a Valid RESET Output Down to $V_{CC}=0V$	11
11.2 Reset Timing	11
12 PACKAGE OUTLINE DIMENSIONS	12
13 TAPE AND REEL INFORMATION	13

5 Revision History

Note: Page numbers for previous revisions may differ from page numbers in the current version.

Version	Change Date	Change Item
A.1	2021/08/09	Initial version completed
A.2	2022/05/09	1. Update PACKAGE MARKING on Page 5@RevA.1 2. Update Operating Temperature Range :-40°C to +125°C
A.3	2022/05/10	Update TYPICAL OPERATING CHARACTERISTICS
A.4	2022/11/25	1. Update TYPICAL OPERATING CHARACTERISTICS 2. Update PACKAGE/ORDERING INFORMATION

6 PACKAGE/ORDERING INFORMATION ⁽¹⁾

PRODUCT	ORDERING NUMBER	TEMPERATURE RANGE	PACKAGE LEAD	PACKAGE MARKING ^(2/3)	PACKAGE OPTION
RS809	RS809-1.63YSF3	-40°C ~+125°C	SOT23	809A	Tape and Reel,3000
	RS809-2.63YSF3	-40°C ~+125°C	SOT23	809B	Tape and Reel,3000
	RS809-2.93YSF3	-40°C ~+125°C	SOT23	809C	Tape and Reel,3000
	RS809-3.08YSF3	-40°C ~+125°C	SOT23	809D	Tape and Reel,3000
	RS809-4.00YSF3	-40°C ~+125°C	SOT23	809E	Tape and Reel,3000
	RS809-4.40YSF3	-40°C ~+125°C	SOT23	809F	Tape and Reel,3000
	RS809-4.65YSF3	-40°C ~+125°C	SOT23	809G	Tape and Reel,3000

NOTE:

- (1) This information is the most current data available for the designated devices. This data is subject to change without notice and revision of this document. For browser-based versions of this data sheet, refer to the right-hand navigation.
- (2) There may be additional marking, which relates to the lot trace code information (data code and vendor code), the logo or the environmental category on the device.
- (3) A, B, C, D, E, F, G represents different Reset Thresholds.

7 PIN CONFIGURATIONS

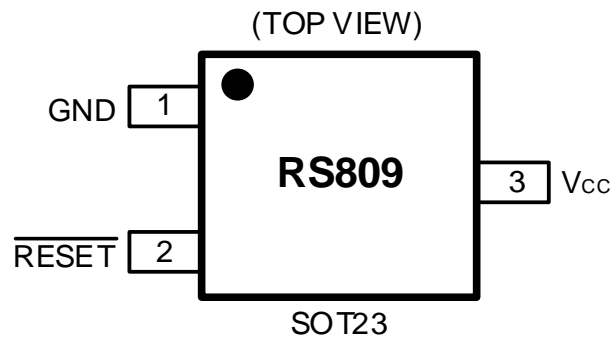

PIN DESCRIPTION

PIN	NAME	FUNCTION
SOT23		
1	GND	Ground, reference for all signals.
2	$\overline{\text{RESET}}$	Active-Low Reset Output remains low while V_{CC} is below the reset threshold, and for at least 200ms after V_{CC} rises above the reset threshold.
3	V_{CC}	Power Supply Voltage that is monitored.

8 SPECIFICATIONS

8.1 Absolute Maximum Ratings ⁽¹⁾

over operating free-air temperature range (unless otherwise noted) ⁽¹⁾⁽²⁾

		MIN	MAX	UNIT
V _{CC}	Supply voltage range	-0.5	6.0	V
V _I	Input voltage range ⁽²⁾	-0.5	6.0	V
V _O	Voltage range applied to any output in the high-impedance or power-off state ⁽²⁾	-0.5	6.0	V
V _O	Voltage range applied to any output in the high or low state ⁽²⁾⁽³⁾	-0.5	V _{CC} +0.5	V
I _{IK}	Input clamp current	V _I <0	-20	mA
I _{OK}	Output clamp current	V _O <0	-20	mA
I _O	Continuous output current		±20	mA
	Continuous current through V _{CC} or GND		±20	mA
T _J	Junction temperature ⁽⁴⁾	-65	150	°C
T _{stg}	Storage temperature	-65	150	°C
T _A	Operating temperature	-40	125	°C

(1) Stresses beyond those listed under *Absolute Maximum Ratings* may cause permanent damage to the device. These are stress ratings only, and functional operation of the device at these or any other conditions beyond those indicated under *Recommended Operating Conditions* is not implied. Exposure to absolute-maximum-rated conditions for extended periods may affect device reliability.

(2) The input and output negative-voltage ratings may be exceeded if the input and output current ratings are observed.

(3) The value of V_{CC} is provided in the *Recommended Operating Conditions table*.

(4) The maximum power dissipation is a function of T_{J(MAX)}, R_{θJA}, and T_A. The maximum allowable power dissipation at any ambient temperature is P_D = (T_{J(MAX)} - T_A) / R_{θJA}. All numbers apply for packages soldered directly onto a PCB.

8.2 ESD Ratings

The following ESD information is provided for handling of ESD-sensitive devices in an ESD protected area only.

		VALUE	UNIT
V _(ESD) Electrostatic discharge	Human-body model (HBM), per ANSI/ESDA/JEDEC JS-001 ⁽¹⁾	±6000	V
	Machine model (MM)	±300	V

(1) JEDEC document JEP155 states that 500 V HBM allows safe manufacturing with a standard ESD control process.



ESD SENSITIVITY CAUTION

ESD damage can range from subtle performance degradation to complete device failure. Precision integrated circuits may be more susceptible to damage because very small parametric changes could cause the device not to meet its published specifications.

8.3 Thermal Information:

THERMAL METRIC ⁽¹⁾		RS809	UNIT
		3 PINS	
		SOT23	
R _{θJA}	Junction-to-ambient thermal resistance	185.6	°C/W
R _{θJC(top)}	Junction-to-case (top) thermal resistance	104.3	°C/W
R _{θJB}	Junction-to-board thermal resistance	54.5	°C/W
Ψ _{JT}	Junction-to-top characterization parameter	31.0	°C/W
Ψ _{JB}	Junction-to-board characterization parameter	54.5	°C/W
R _{θJC(bot)}	Junction-to-case (bottom) thermal resistance	N/A	°C/W

(1) Thermal resistance varies with operating conditions.

8.4 ELECTRICAL CHARACTERISTICS

V_{CC} = 2.7V to 5.5V for RS809-2.63; V_{CC} = 3V to 5.5V for RS809-2.93; V_{CC} = 3.16V to 5.5V for RS809-3.08; V_{CC} = 4.1V to 5.5V for RS809-4.00; V_{CC} = 4.77V to 5.5V for RS809-4.65; T_A = -40°C to +125°C, unless otherwise noted, typical at 25°C.)

PARAMETER	SYMBOL	TEST CONDITIONS	Operating free-air temperature (T_A)						UNIT
			-40°C to 85°C			-40°C to 125°C			
			MIN	TYP	MAX	MIN	TYP	MAX	
Supply Voltage	V_{CC}		1.0		5.5	1.0		5.5	V
Supply Current	I_{SUPPLY}			20	40		20	40	μA
Reset Threshold	V_{RT}	RS809-2.63	2.56	2.63	2.70	2.52	2.63	2.74	V
		RS809-2.93	2.86	2.93	3.00	2.81	2.93	3.05	
		RS809-3.08	3.00	3.08	3.16	2.95	3.08	3.21	
		RS809-4.00	3.90	4.00	4.10	3.84	4.00	4.17	
		RS809-4.65	4.54	4.65	4.72	4.46	4.65	4.84	
Reset Threshold Hysteresis		RS809-2.63		12			12		mV
		RS809-2.93		14			14		
		RS809-3.08		15			15		
		RS809-4.00		20			20		
		RS809-4.65		23			23		
Reset Pulse Width	t_{RS}		100	200	350	100	200	400	ms
Reset Threshold Temperature Coefficient				30			30		ppm/°C
V_{CC} to \overline{RESET} delay	t_{RD}	$V_{CC}=3.3V$, RS809-2.93		30			30		μs
\overline{RESET} Output voltage	High	$I_{SOURCE} = 500\mu A$	0.7x V_{CC}			0.7x V_{CC}			V
	Low	$I_{SINK} = 1.2mA$	0.4			0.4			

8.5 TYPICAL OPERATING CHARACTERISTICS

NOTE: The graphs and tables provided following this note are a statistical summary based on a limited number of samples and are provided for informational purposes only.

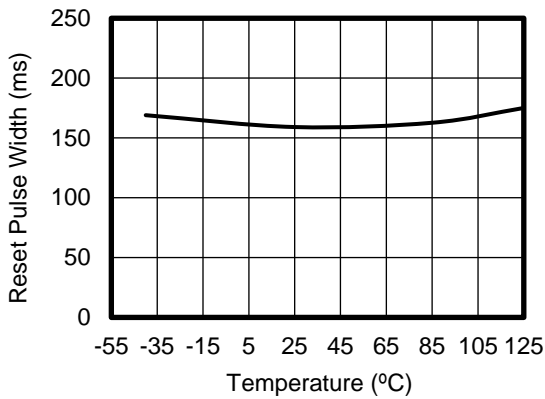

Figure 1. Reset Pulse Width vs Temperature

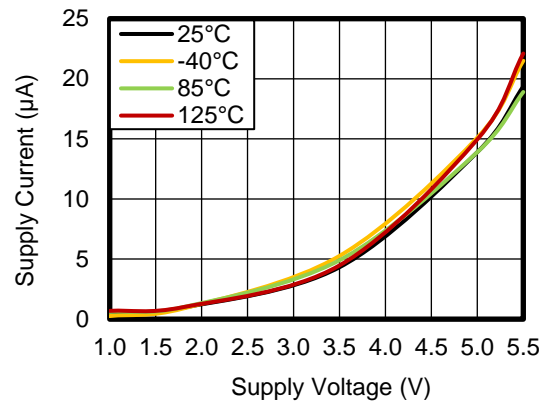

Figure 2. Supply Voltage vs Supply Current

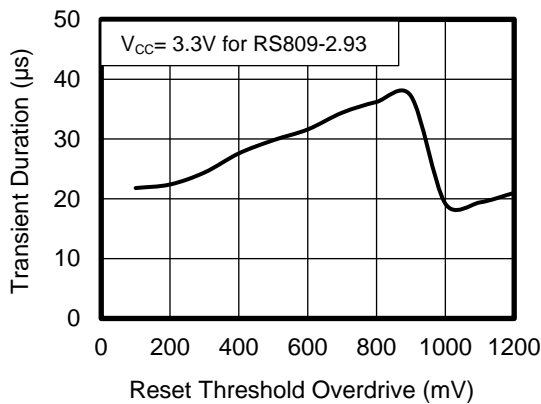

Figure 3. Transient Duration vs Reset Threshold Overdrive

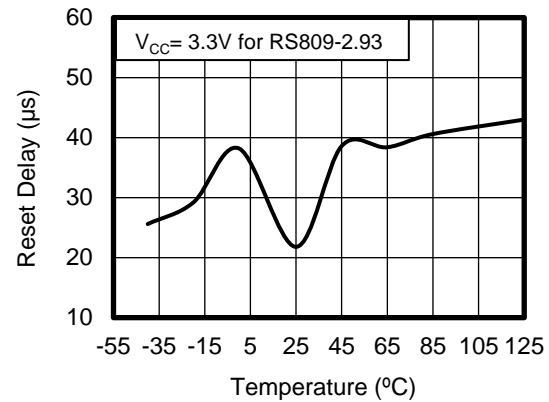

Figure 4. Reset Delay vs Temperature

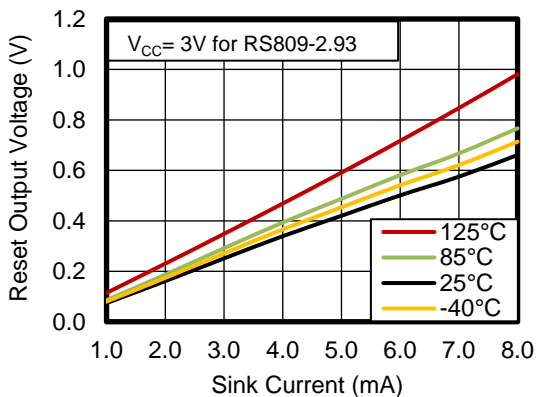

Figure 5. Reset Output Voltage vs Sink Current

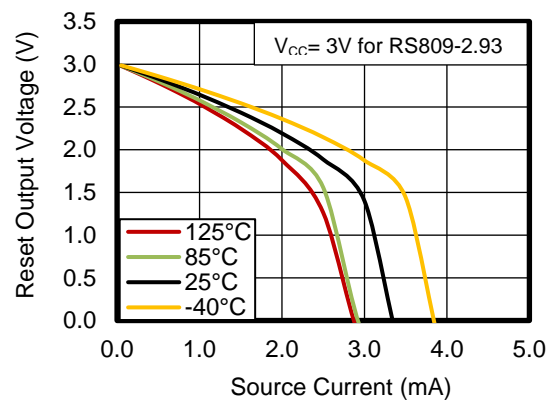

Figure 6. Reset Output Voltage vs Source Current

TYPICAL OPERATING CHARACTERISTICS

NOTE: The graphs and tables provided following this note are a statistical summary based on a limited number of samples and are provided for informational purposes only.

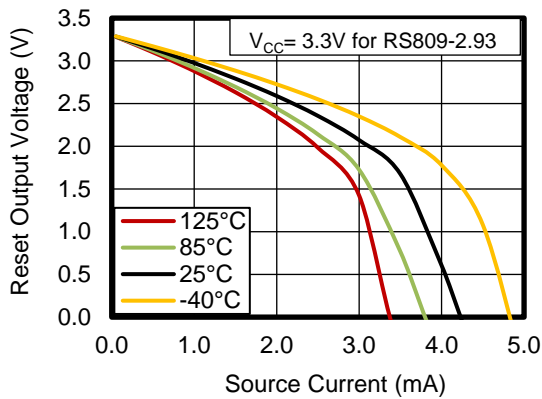

Figure 7. Reset Output Voltage vs Source Current

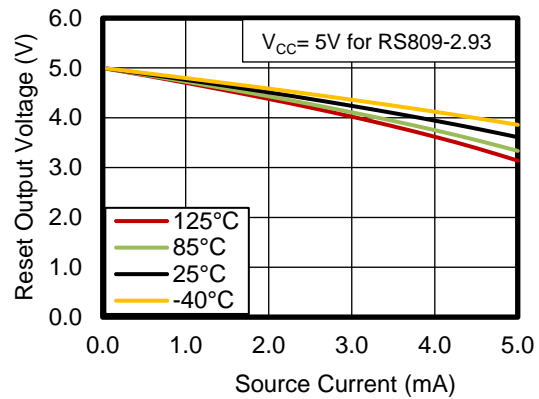

Figure 8. Reset Output Voltage vs Source Current

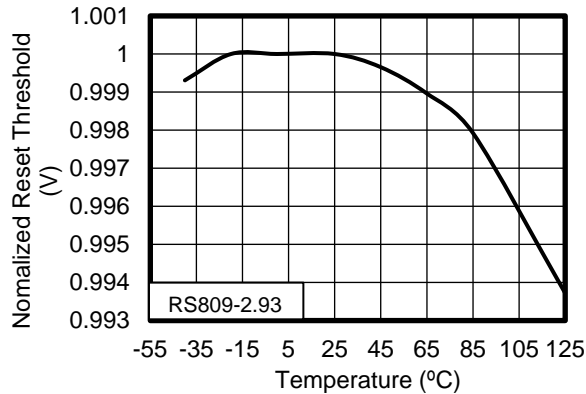

Figure 9. Normalized Reset Threshold vs Temperature

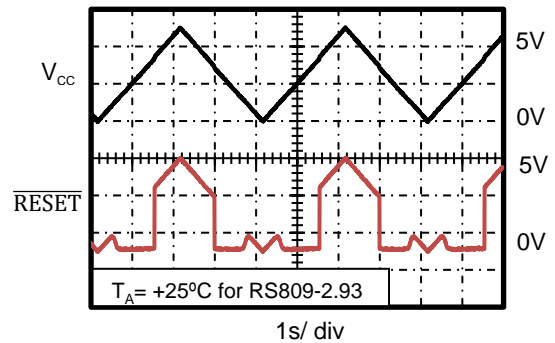

Figure 10. Reset Output Voltage vs Supply Voltage

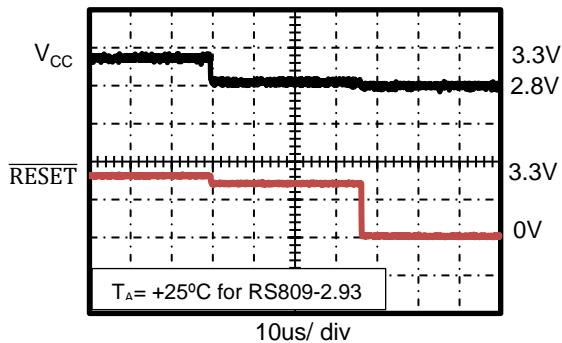
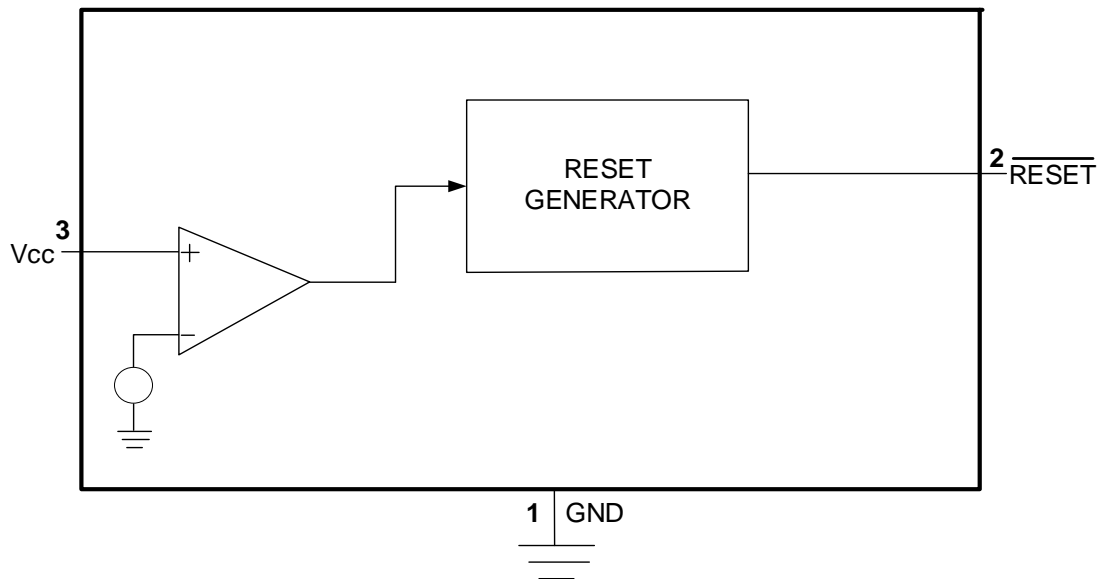

Figure 11. Reset Response Time

9 Function Block Diagram



10 Detailed Description

A microprocessor's (μP 's) reset input starts the μP in a known state. The RS809 assert reset to prevent code-execution errors during power-up, power-down or brownout conditions. They assert a reset signal whenever the V_{CC} supply voltage declines below a preset threshold, keeping it asserted for at least 200ms after V_{CC} has risen above the reset threshold. The RS809 have a push-pull output stage.

11 Application and Implementation

Information in the following applications sections is not part of the Runic component specification, and Runic does not warrant its accuracy or completeness. Runic’s customers are responsible for determining suitability of components for their purposes. Customers should validate and test their design implementation to confirm system functionality.

11.1 Ensuring a Valid RESET Output Down to $V_{CC}=0V$

When V_{CC} falls down below 1V, the RS809 \overline{RESET} output no longer sinks current, it becomes an open circuit. High-impedance CMOS logic inputs can drift to undetermined voltages if left un-driven. If a pull-down resistor is added to the \overline{RESET} pin, as shown in Figure 12, any stray charge or leakage currents will be drained to ground, holding \overline{RESET} low. Resistor value (R1) is not critical. It should be about 100K Ω , large enough not to load \overline{RESET} and small enough to pull \overline{RESET} to ground.

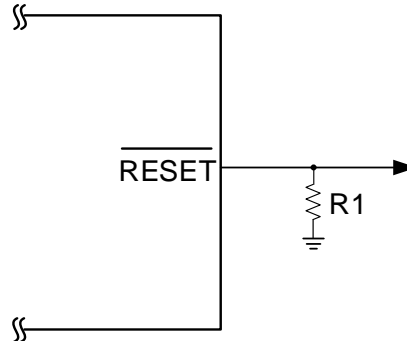

Figure 12. RESET Valid to Ground Circuit

11.2 Reset Timing

The reset signal is asserted low for the RS809 when the power supply voltage falls below the threshold trip voltage and remains asserted for at least 200ms after the power supply voltage has risen above the threshold.

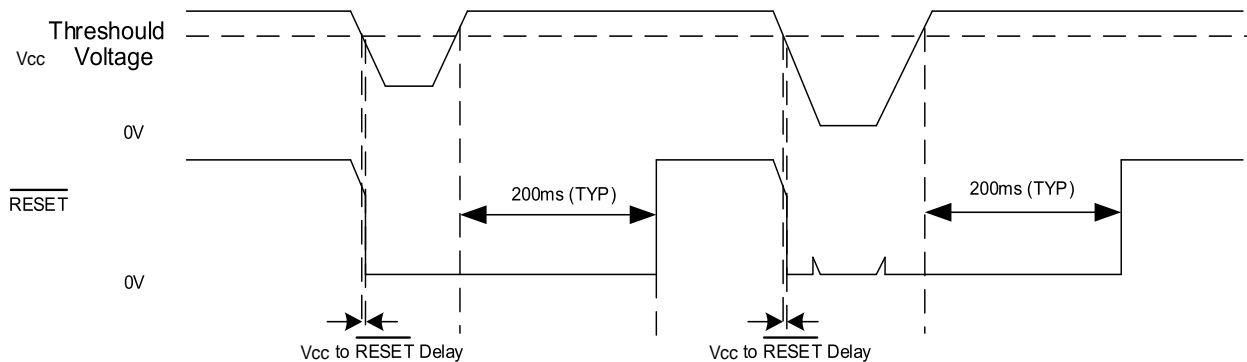
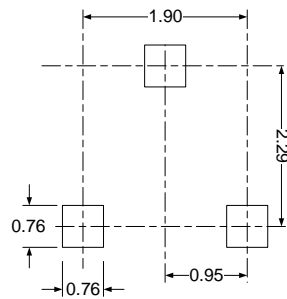
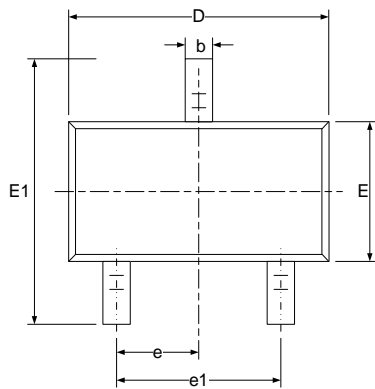

Figure 13. RESET Timing Diagram

12 PACKAGE OUTLINE DIMENSIONS

SOT23



RECOMMENDED LAND PATTERN (Unit: mm)

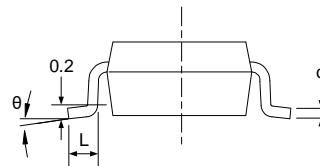
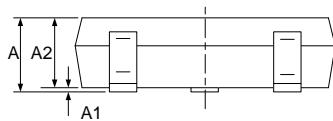

Symbol	Dimensions In Millimeters		Dimensions In Inches	
	Min	Max	Min	Max
A	0.900	1.150	0.035	0.045
A1	0.000	0.100	0.000	0.004
A2	0.900	1.050	0.035	0.041
b	0.300	0.500	0.012	0.020
c	0.080	0.150	0.003	0.006
D	2.800	3.000	0.110	0.118
E	1.200	1.400	0.047	0.055
E1	2.250	2.550	0.089	0.100
e	0.950 (BSC)		0.037 (BSC)	
e1	1.800	2.000	0.071	0.079
L	0.300	0.500	0.012	0.020
θ	0°	8°	0°	8°

NOTE:

- A. All linear dimension is in millimeters.
- B. This drawing is subject to change without notice.
- C. Body dimensions do not include mold flash or protrusion. Mold flash and protrusion shall not exceed 0.15 per side.
- D. BSC: Basic Dimension. Theoretically exact value shown without tolerances.

13 TAPE AND REEL INFORMATION

REEL DIMENSIONS

TAPE DIMENSION

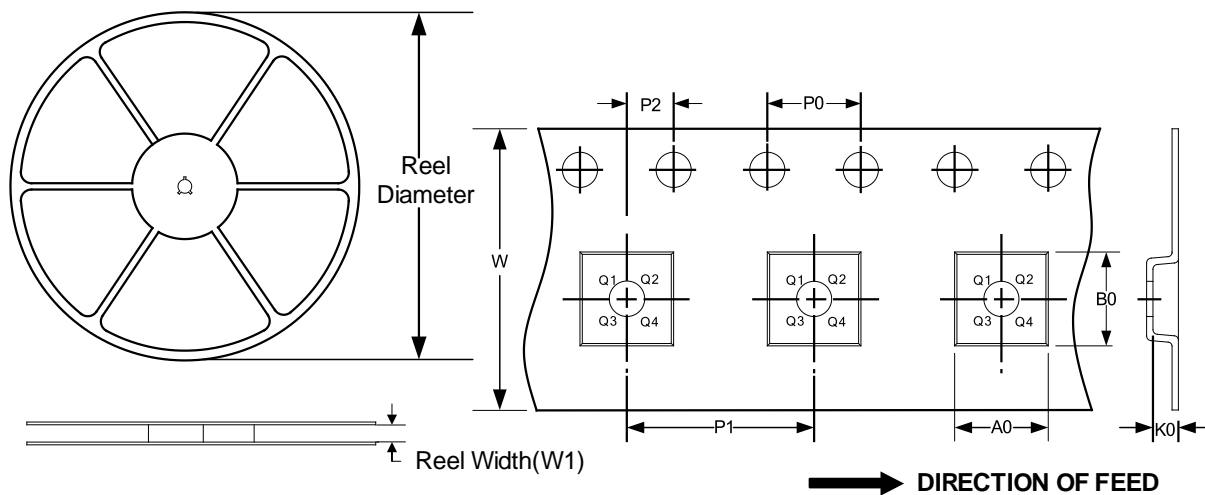

NOTE: The picture is only for reference. Please make the object as the standard.

KEY PARAMETER LIST OF TAPE AND REEL

Package Type	Reel Diameter	Reel Width (mm)	A0 (mm)	B0 (mm)	K0 (mm)	P0 (mm)	P1 (mm)	P2 (mm)	W (mm)	Pin1 Quadrant
SOT23	7"	9.5	3.15	2.77	1.22	4.0	4.0	2.0	8.0	Q3

NOTE:

1. All dimensions are nominal.
2. Plastic or metal protrusions of 0.15mm maximum per side are not included.

IMPORTANT NOTICE AND DISCLAIMER

Jiangsu Runic Technology Co., Ltd. will accurately and reliably provide technical and reliability data (including data sheets), design resources (including reference designs), application or other design advice, WEB tools, safety information and other resources, without warranty of any defect, and will not make any express or implied warranty, including but not limited to the warranty of merchantability Implied warranty that it is suitable for a specific purpose or does not infringe the intellectual property rights of any third party.

These resources are intended for skilled developers designing with Runic products You will be solely responsible for: (1) Selecting the appropriate products for your application; (2) Designing, validating and testing your application; (3) Ensuring your application meets applicable standards and any other safety, security or other requirements; (4) Runic and the Runic logo are registered trademarks of Runic Incorporated. All trademarks are the property of their respective owners; (5) For change details, review the revision history included in any revised document. The resources are subject to change without notice. Our company will not be liable for the use of this product and the infringement of patents or third-party intellectual property rights due to its use.

X-ON Electronics

Largest Supplier of Electrical and Electronic Components

Click to view similar products for [Supervisory Circuits](#) category:

Click to view products by [RUNIC](#) manufacturer:

Other Similar products are found below :

[CAT853STBI-T3](#) [RT9818C-27GU3](#) [DS1232L](#) [NCV302HSN45T1G](#) [STM6710FWB7F](#) [PT7M6127NLTA3EX](#) [XC6118C25AGR-G](#)
[ISL88011IH526Z-TK](#) [ISL88013IH529Z-TK](#) [ISL88705IP846Z](#) [ISL88706IP831Z](#) [ISL88708IB844Z](#) [ISL88708IP831Z](#) [TCM811MERCTR](#)
[X40420S14-A](#) [X40421S14-C](#) [X40430S14-A](#) [X40430S14I-A](#) [X40430S14I-B](#) [X40431S14-A](#) [X40431S14-B](#) [X40431S14-C](#) [X40431S14I-A](#)
[X40431S14I-B](#) [X40431S14I-C](#) [X4043P-2.7](#) [X4043PI-2.7](#) [X4043S8-2.7T1](#) [X4043S8IZ-2.7](#) [X4043S8IZT1](#) [X4043S8T1](#) [X4045P](#) [X4045PI](#)
[X4045PI-2.7](#) [X4045S8-2.7T1](#) [X4045S8IZ](#) [X4045S8T1](#) [X4163P](#) [X4163P-2.7](#) [X4163PI](#) [X4163PI-2.7](#) [X4163S8](#) [X4165P](#) [X4165P-2.7](#)
[X4165PI](#) [X4165PI-2.7](#) [X4165S8I-2.7](#) [X4283S8I](#) [X4323S8-2.7](#) [X4323S8I-2.7](#)