

36V, 1.2MHz Rail-to-Rail Output CMOS Operational Amplifier

FEATURES

- **HIGH GAIN BANDWIDTH:1.2MHz**
- **INPUT OFFSET VOLTAGE:±0.8mV (Typical)**
- **QUIESCENT CURRENT:100uA/Amp**
- **Rail to Rail Output**
- **Common-Mode Input Voltage Range Include Ground**
- **Supply Range: +3V to +36V**
- **SPECIFIED UP TO +125°C**
- **Micro SIZE PACKAGES: SOT23-5**

APPLICATIONS

- **SENSORS**
- **PHOTODIODE AMPLIFICATION**
- **ACTIVE FILTERS**
- **TEST EQUIPMENT**
- **DRIVING A/D CONVERTERS**

DESCRIPTION

The RS841X families of products offer high voltage (36V) operation and rail-to-rail output, as well as excellent speed/power consumption ratio, providing an excellent bandwidth (1.2MHz) and slew rate of 0.67V/us. The op-amps are unity gain stable and feature an ultra-low input bias current.

The devices are stable at capacitance up to 300pF. The input can operate normally within 100mV below of the negative power rail to 2V below of the positive power rail. The RS841X families of operational amplifiers are specified at the full temperature range of -40°C to +125°C under single power supplies of 3V to 36V or dual power supplies of ±1.5V to ±18V.

Device Information ⁽¹⁾

PART NUMBER	PACKAGE	BODY SIZE(NOM)
RS8411	SOT23-5	2.90mm x 1.60mm
RS8412	SOIC-8	4.90mm x 3.90mm
	MSOP-8	3.00mm x 3.00mm
RS8414	SOIC-14	8.65mm x 3.90mm
	TSSOP-14	5.00mm x 4.40mm

(1) For all available packages, see the orderable addendum at the end of the data sheet.

Revision History

Note: Page numbers for previous revisions may differ from page numbers in the current version.

Version	Change Date	Change Item
A.1	2020.12	Initial version completed

Pin Configuration and Functions (Top View)

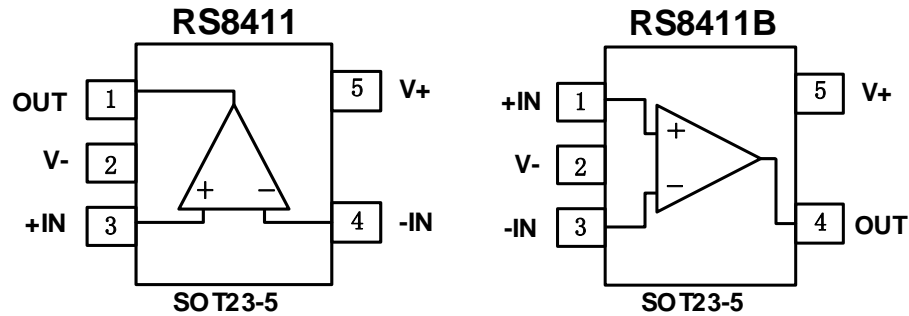

Pin Description

NAME	PIN		I/O	DESCRIPTION
	RS8411	RS8411B		
+IN	3	1	I	Positive (noninverting) input
V-	2	2	-	Negative (lowest) power supply or ground (for single supply operation)
-IN	4	3	I	Negative (inverting) input
OUT	1	4	O	Output
V+	5	5	-	Positive (highest) power supply

Pin Configuration and Functions (Top View)

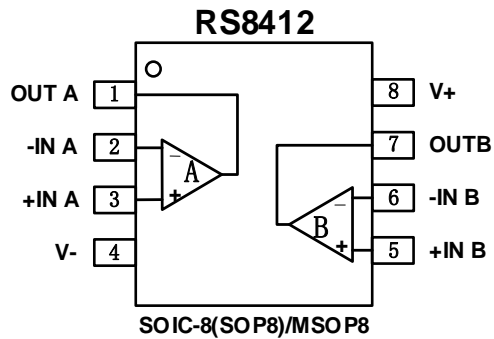

Pin Description

NAME	PIN	I/O	DESCRIPTION
	SOIC-8(SOP8)/MSOP-8		
-INA	2	I	Inverting input, channel A
+INA	3	I	Noninverting input, channel A
-INB	6	I	Inverting input, channel B
+INB	5	I	Noninverting input, channel B
OUTA	1	O	Output, channel A
OUTB	7	O	Output, channel B
V-	4	-	Negative (lowest) power supply or ground (for single supply operation)
V+	8	-	Positive (highest) power supply

Pin Configuration and Functions (Top View)

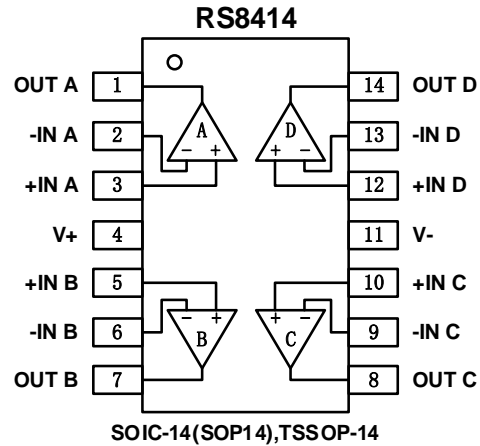

Pin Description

NAME	PIN	I/O	DESCRIPTION
	SOIC-14(SOP14)/TSSOP-14		
-INA	2	I	Inverting input, channel A
+INA	3	I	Noninverting input, channel A
-INB	6	I	Inverting input, channel B
+INB	5	I	Noninverting input, channel B
-INC	9	I	Inverting input, channel C
+INC	10	I	Noninverting input, channel C
-IND	13	I	Inverting input, channel D
+IND	12	I	Noninverting input, channel D
OUTA	1	O	Output, channel A
OUTB	7	O	Output, channel B
OUTC	8	O	Output, channel C
OUTD	14	O	Output, channel D
V-	11	-	Negative (lowest) power supply or ground (for single supply operation)
V+	4	-	Positive (highest) power supply

SPECIFICATIONS

Absolute Maximum Ratings

Over operating free-air temperature range (unless otherwise noted) ⁽¹⁾

		MIN	MAX	UNIT
Voltage	Supply, $V_s=(V+) - (V-)$	-0.7	36	V
	Signal input pin ⁽²⁾	(V-)-0.2	(V+) +0.2	
	Signal output pin ⁽³⁾	(V-)-0.2	(V+) +0.2	
Current	Signal input pin ⁽²⁾	-10	10	mA
	Signal output pin ⁽³⁾	-100	100	mA
	Output short-circuit ⁽⁴⁾	Continuous		
Temperature	Operating range, T_A	-40	125	°C
	Junction, T_J		150	
	Storage, T_{stg}	-55	150	

(1) Stresses above these ratings may cause permanent damage. Exposure to absolute maximum conditions for extended periods may degrade device reliability. These are stress ratings only, and functional operation of the device at these or any other conditions beyond those specified is not implied.

(2) Input terminals are diode-clamped to the power-supply rails. Input signals that can swing more than 0.5V beyond the supply rails should be current-limited to 10mA or less.

(3) Output terminals are diode-clamped to the power-supply rails. Output signals that can swing more than 0.5V beyond the supply rails should be current-limited to ± 100 mA or less.

(4) Short-circuit to ground, one amplifier per package.

ESD Ratings

			VALUE	UNIT
$V_{(ESD)}$	Electrostatic discharge	Human-body model (HBM)	± 5000	V
		Machine Model (MM)	± 200	

(1) JEDEC document JEP155 states that 500-V HBM allows safe manufacturing with a standard ESD control process.

Recommended Operating Conditions

Over operating free-air temperature range (unless otherwise noted)

		MIN	NOM	MAX	UNIT
Supply voltage, $V_s=(V+) - (V-)$	Single-supply	3		36	V
	Dual-supply	± 1.5		± 18	

Thermal Information

THERMAL METRIC ⁽¹⁾		RS8411	RS8412		RS8414		UNIT
		5PINS	8PINS		14PINS		
		SOT23-5	SOIC-8	MSOP-8	SOIC-14	TSSOP-14	
$R_{\theta JA}$	Junction-to-ambient thermal resistance	273.8	124.7	165	83.8	120.8	°C/W
$R_{\theta JC(top)}$	Junction-to-case(top) thermal resistance	126.8	66.9	53	70.7	34.3	°C/W
$R_{\theta JB}$	Junction-to-board thermal resistance	85.9	67.9	87	59.5	62.8	°C/W
Ψ_{JT}	Junction-to-top characterization parameter	10.9	19.2	4.9	11.6	10.5	°C/W
Ψ_{JB}	Junction-to-board characterization parameter	84.9	67.2	85	37.7	56.5	°C/W
$R_{\theta JC(bot)}$	Junction-to-case(bottom) thermal resistance	N/A	N/A	N/A	N/A	N/A	°C/W

PACKAGE/ORDERING INFORMATION

Orderable Device	Package Type	Pin	Channel	Op Temp(°C)	Device Marking ⁽¹⁾	Package Qty
RS8411XF	SOT23-5	5	1	-40°C~125°C	8411	Tape and Reel,3000
RS8411BXF	SOT23-5	5	1	-40°C~125°C	8411B	Tape and Reel,3000
RS8412XK	SOIC-8(SOP8)	8	2	-40°C~125°C	RS8412	Tape and Reel,4000
RS8412XM	MSOP-8	8	2	-40°C~125°C	RS8412	Tape and Reel,4000
RS8414XP	SOIC-14(SOP14)	14	4	-40°C~125°C	RS8414	Tape and Reel,4000
RS8414XQ	TSSOP-14	14	4	-40°C~125°C	RS8414	Tape and Reel,4000

NOTE:

- (1) There may be additional marking, which relates to the lot trace code information(data code and vendor code), the logo or the environmental category on the device.

ELECTRICAL CHARACTERISTICS

(At $T_A = +25^\circ\text{C}$, $V_S = 3\text{V}$ to 36V , $R_L = 10\text{k}\Omega$ connected to $V_S/2$, and $V_{OUT} = V_S/2$, unless otherwise noted.)

PARAMETER		CONDITIONS	T_J	RS841X			UNITS
				MIN	TYP	MAX	
POWER SUPPLY							
V_S	Operating Voltage Range		25°C	3		36	V
IQ	Quiescent Current/Amplifier	$V_S = \pm 2.5\text{V}$, $I_O = 0\text{mA}$	25°C		100	200	μA
		$V_S = \pm 18\text{V}$, $I_O = 0\text{mA}$			150	300	
PSRR	Power-Supply Rejection Ratio	$V_S = 5\text{V}$ to 36V	25°C	98	120		dB
INPUT							
V_{OS}	Input Offset Voltage	$V_{CM} = V_S/2$	25°C	-4	± 0.8	4	mV
			-40°C to 125°C		± 1.1		
V_{OS} Tc	Input Offset Voltage Average Drift		-40°C to 125°C		3		$\mu\text{V}/^\circ\text{C}$
IB	Input Bias Current	$V_{CM} = 0\text{V}$	25°C		10	60	μA
			-40°C to 125°C		600		
I_{OS}	Input Offset Current	$V_{CM} = 0\text{V}$	25°C		10	60	μA
			-40°C to 125°C		600		
V_{CM}	Common-Mode Voltage Range	$V_S = \pm 18\text{V}$	25°C	(V $-$)-0.1		(V $+$)-2	V
CMRR	Common-Mode Rejection Ratio	$V_S = \pm 2.5\text{V}$, $V_{CM} = (\text{V}-)-0.1\text{V}$ to (V $+$)-2V	25°C	70	110		dB
		$V_S = \pm 18\text{V}$, $V_{CM} = (\text{V}-)-0.1\text{V}$ to (V $+$)-2V	25°C	70			
OUTPUT							
A_{OL}	Open-Loop Voltage Gain	$R_L = 10\text{k}\Omega$, $V_O = (\text{V}-)-0.6\text{V}$ to (V $+$)-0.6V	25°C	92	115		dB
V_{OH}	Output Swing	$V_S = \pm 18\text{V}$, $R_L = 10\text{k}\Omega$	25°C	17.85			V
V_{OL}						-17.85	
I_{SC}	Short-circuit current	$V_S = 36\text{V}$, $V_O = 0\text{V}$	25°C		70		mA
C_{LOAD}	Capacitive load drive		25°C		100		pF
FREQUENCY RESPONSE							
SR	Slew Rate	$G = +1$, $C_L = 100\text{pF}$	25°C		0.67		V/ μs
GBW	Gain-Bandwidth Product		25°C		1.2		MHz
t_S	Setting Time, 0.01%	$V_S = \pm 2.5\text{V}$, $G = +1$, $C_L = 100\text{pF}$, Step=2V	25°C		5		μs
t_{OR}	Overload Recovery Time	V_{IN} Gain $\geq V_S$, $G = 11$	25°C		5		μs
t_{ON}	Turn On Time		25°C		10		μs
NOISE							
E_n	Input Voltage Noise	$f = 0.1\text{Hz}$ to 10Hz , $V_S = \pm 2.5\text{V}$	25°C		16		μV_{pp}
e_n	Input Voltage Noise Density	$f = 1\text{KHz}$	25°C		TBD		nV/ $\sqrt{\text{Hz}}$

TYPICAL CHARACTERISTICS

At $T_A = +25^\circ\text{C}$, $V_S = \pm 18\text{V}$, $R_L = 10\text{k}\Omega$ connected to $V_S/2$, $V_{OUT} = V_S/2$, unless otherwise noted.

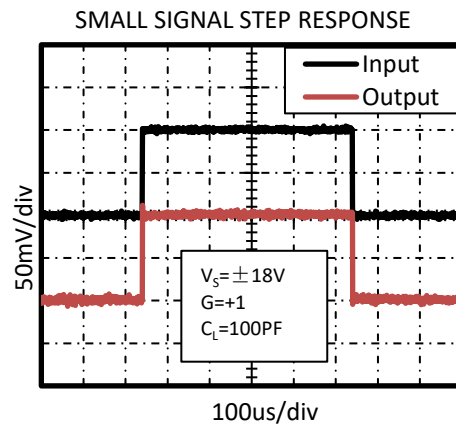
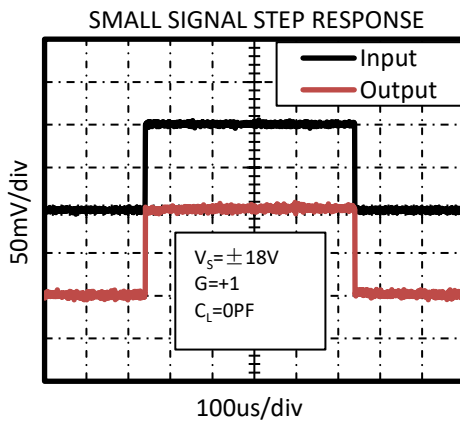
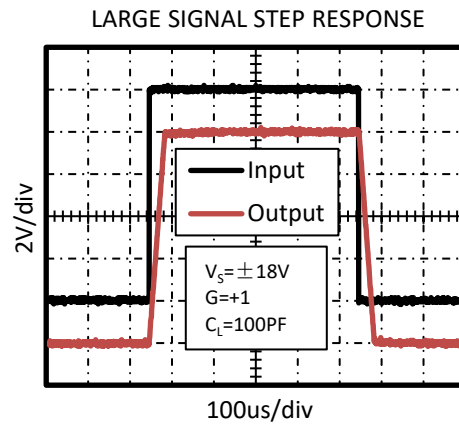
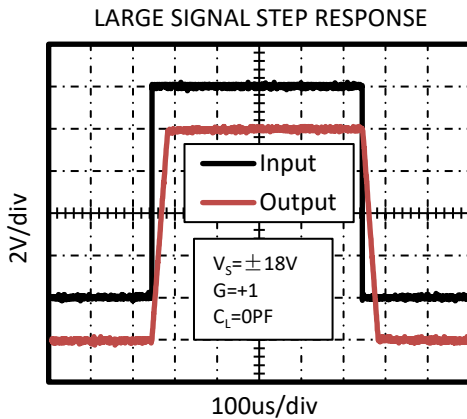
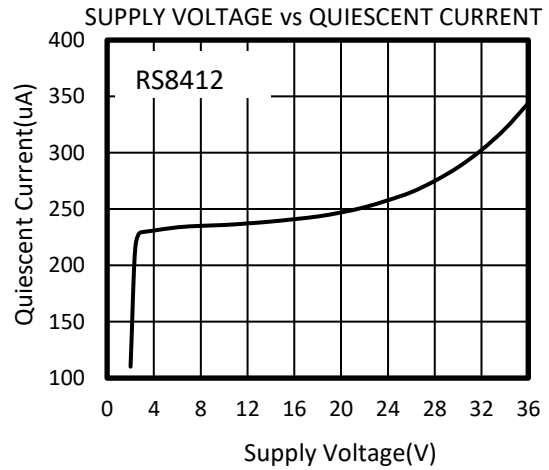
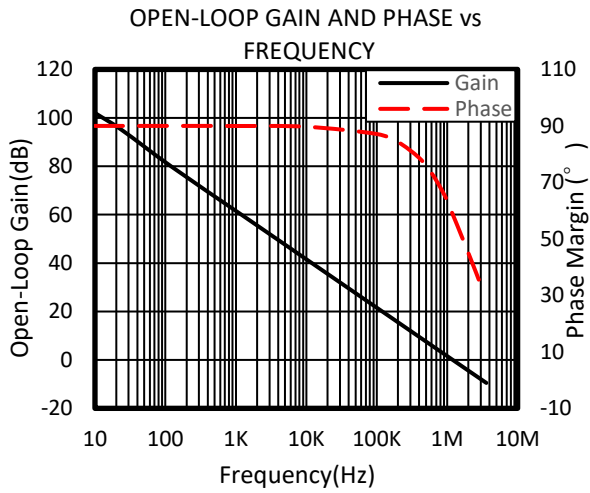

TYPICAL CHARACTERISTICS

At $T_A = +25^\circ\text{C}$, $V_S = \pm 18\text{V}$, $R_L = 10\text{k}\Omega$ connected to $V_S/2$, $V_{OUT} = V_S/2$, unless otherwise noted.

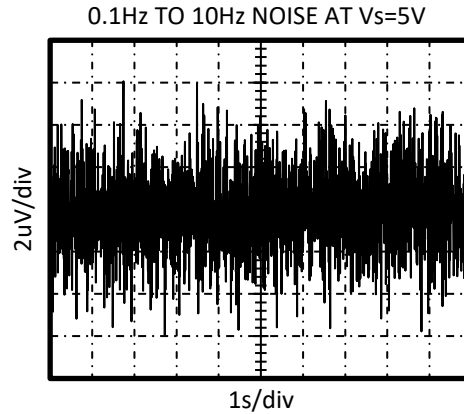
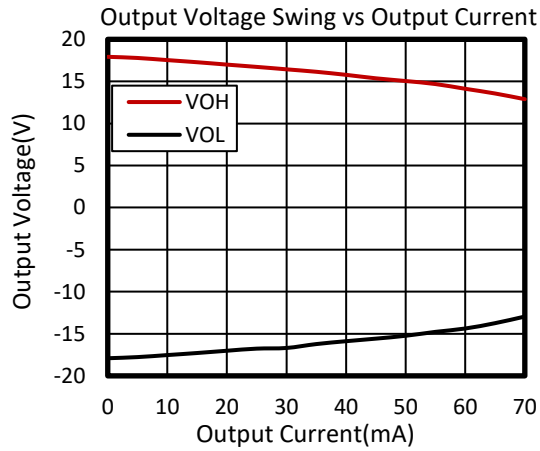
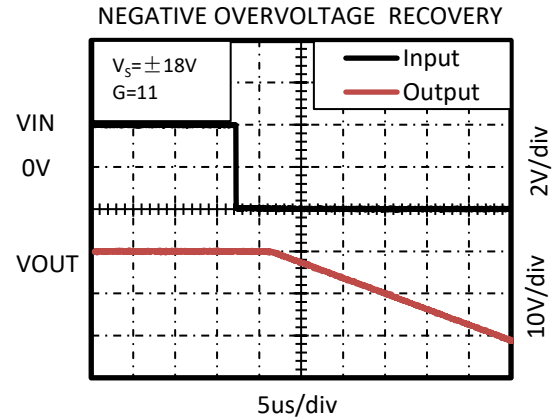
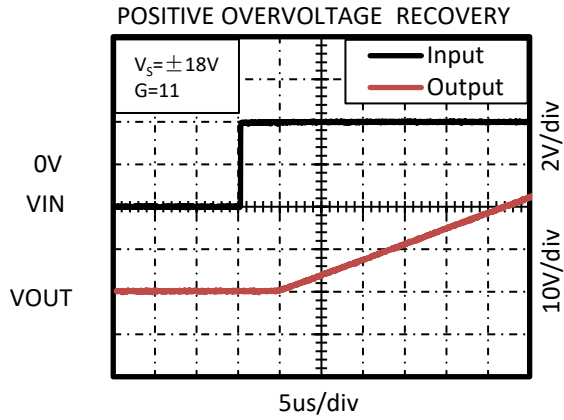

PACKAGE OUTLINE DIMENSIONS

SOT23-5

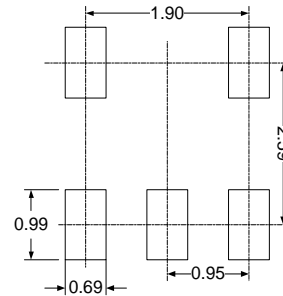
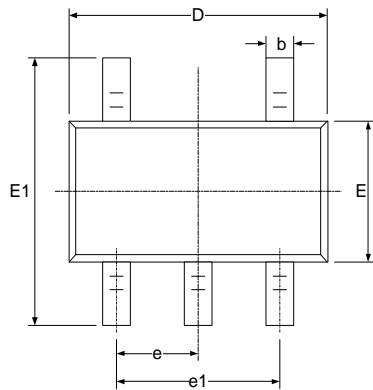
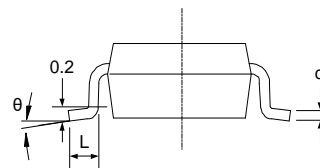
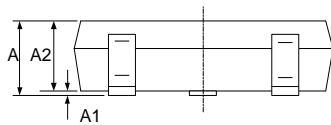
RECOMMENDED LAND PATTERN (Unit: mm)

Symbol	Dimensions In Millimeters		Dimensions In Inches	
	Min	Max	Min	Max
A	1.050	1.250	0.041	0.049
A1	0.000	0.100	0.000	0.004
A2	1.050	1.150	0.041	0.045
b	0.300	0.500	0.012	0.020
c	0.100	0.200	0.004	0.008
D	2.820	3.020	0.111	0.119
E	1.500	1.700	0.059	0.067
E1	2.650	2.950	0.104	0.116
e	0.950(BSC)		0.037(BSC)	
e1	1.800	2.000	0.071	0.079
L	0.300	0.600	0.012	0.024
θ	0°	8°	0°	8°

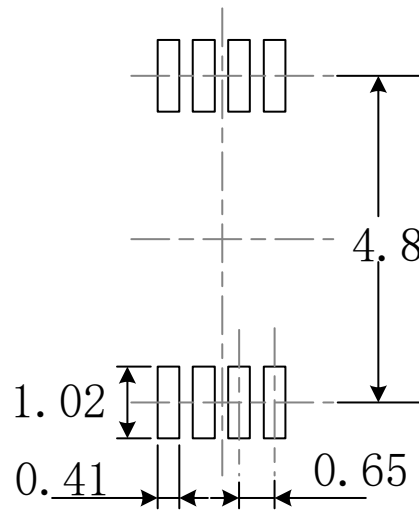
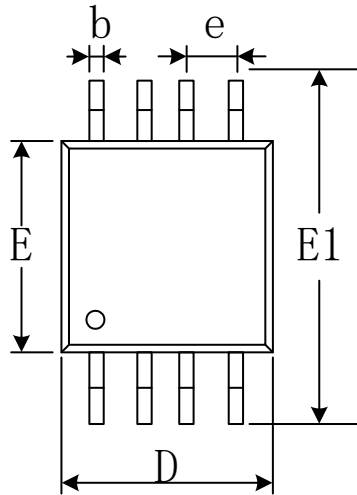
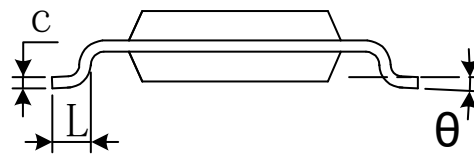
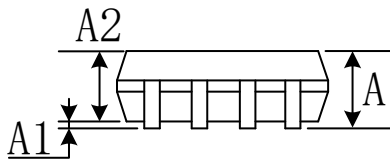
MSOP-8

RECOMMENDED LAND PATTERN (Unit: mm)

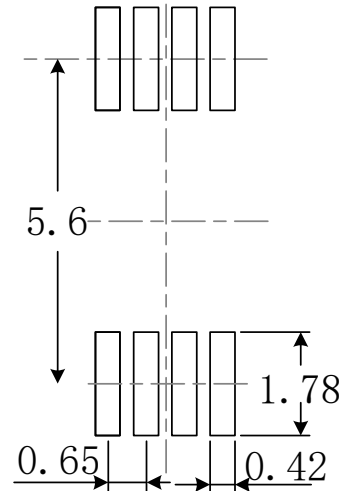
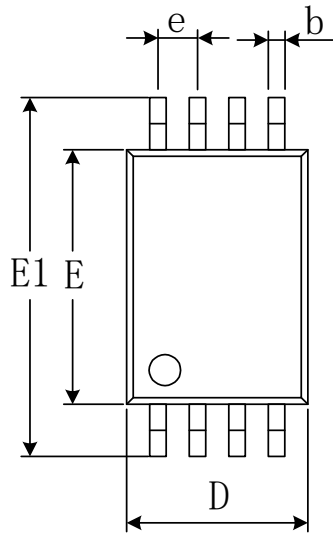
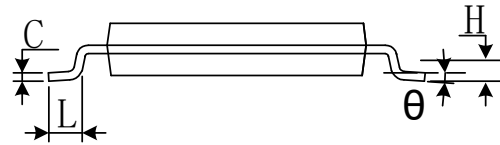
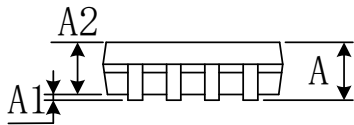
Symbol	Dimensions In Millimeters		Dimensions In Inches	
	Min	Max	Min	Max
A	0.820	1.100	0.032	0.043
A1	0.020	0.150	0.001	0.006
A2	0.750	0.950	0.030	0.037
b	0.250	0.380	0.010	0.015
c	0.090	0.230	0.004	0.009
D	2.900	3.100	0.114	0.122
e	0.650(BSC)		0.026(BSC)	
E	2.900	3.100	0.114	0.122
E1	4.750	5.050	0.187	0.199
L	0.400	0.800	0.016	0.031
θ	0°	6°	0°	6°

TSSOP-14

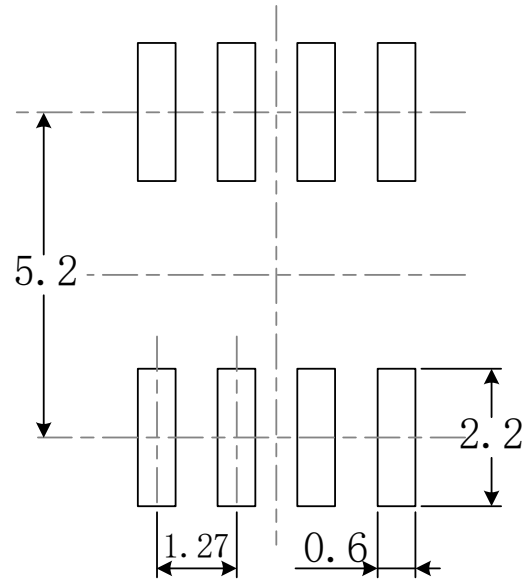
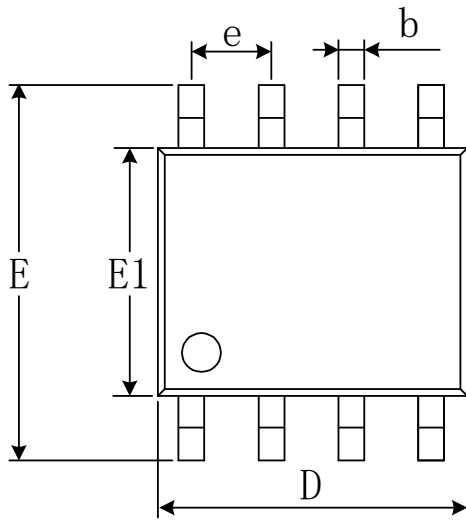
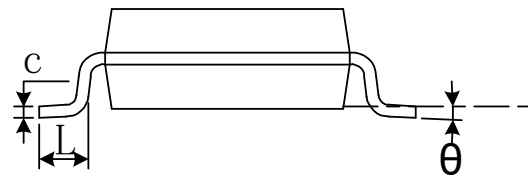
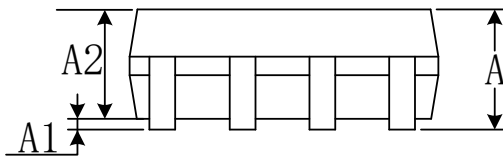
RECOMMENDED LAND PATTERN (Unit: mm)

Symbol	Dimensions In Millimeters		Dimensions In Inches	
	Min	Max	Min	Max
A		1.200		0.047
A1	0.050	0.150	0.002	0.006
A2	0.800	1.050	0.031	0.041
b	0.190	0.300	0.007	0.012
c	0.090	0.200	0.004	0.008
D	4.860	5.100	0.191	0.201
E	4.300	4.500	0.169	0.177
E1	6.250	6.550	0.246	0.258
e	0.650(BSC)		0.026(BSC)	
L	0.500	0.700	0.020	0.028
H	0.25(TYP)		0.01(TYP)	
θ	1°	7°	1°	7°

SOIC-8(SOP8)

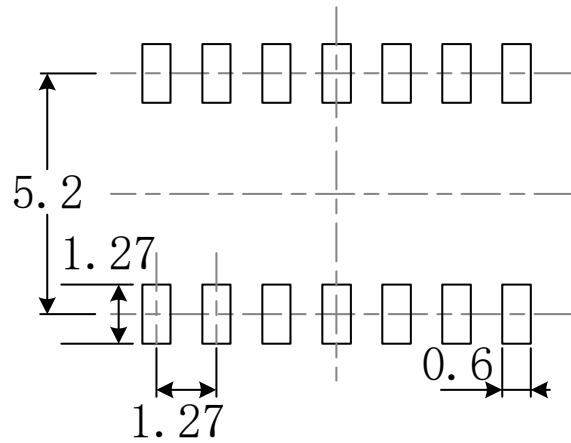
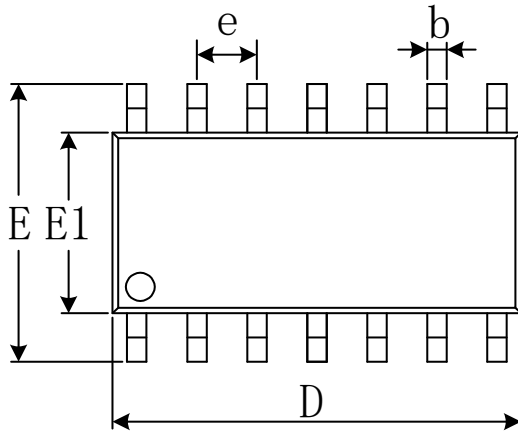
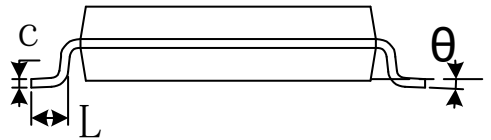
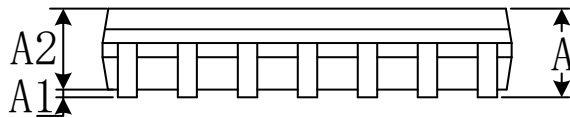
RECOMMENDED LAND PATTERN (Unit: mm)

Symbol	Dimensions In Millimeters		Dimensions In Inches	
	Min	Max	Min	Max
A	1.350	1.750	0.053	0.069
A1	0.100	0.250	0.004	0.010
A2	1.350	1.550	0.053	0.061
b	0.330	0.510	0.013	0.020
c	0.170	0.250	0.007	0.010
D	4.800	5.000	0.189	0.197
e	1.270(BSC)		0.050(BSC)	
E	5.800	6.200	0.228	0.244
E1	3.800	4.000	0.150	0.157
L	0.400	1.270	0.016	0.050
θ	0°	8°	0°	8°

SOIC-14(SOP14)

RECOMMENDED LAND PATTERN (Unit: mm)

Symbol	Dimensions In Millimeters		Dimensions In Inches	
	Min	Max	Min	Max
A	1.350	1.750	0.053	0.069
A1	0.100	0.250	0.004	0.010
A2	1.350	1.550	0.053	0.061
b	0.310	0.510	0.012	0.020
c	0.100	0.250	0.004	0.010
D	8.450	8.850	0.333	0.348
e	1.270(BSC)		0.050(BSC)	
E	5.800	6.200	0.228	0.244
E1	3.800	4.000	0.150	0.157
L	0.400	1.270	0.016	0.050
θ	0°	8°	0°	8°

X-ON Electronics

Largest Supplier of Electrical and Electronic Components

Click to view similar products for [Operational Amplifiers - Op Amps](#) category:

Click to view products by [RUNIC](#) manufacturer:

Other Similar products are found below :

[430227FB](#) [UPC451G2-A](#) [UPC824G2-A](#) [LT1678IS8](#) [042225DB](#) [058184EB](#) [UPC822G2-A](#) [UPC258G2-A](#) [NCS5651MNTXG](#)
[NCV33202DMR2G](#) [NJM324E](#) [NTE925](#) [5962-9080901MCA*](#) [AZV358MTR-G1](#) [AP4310AUMTR-AG1](#) [HA1630D02MMEL-E](#)
[HA1630S01LPEL-E](#) [AZV358MMTR-G1](#) [SCY33178DR2G](#) [NJU77806F3-TE1](#) [NCV5652MUTWG](#) [NCV20034DR2G](#) [NTE778S](#) [NTE871](#)
[NTE924](#) [NTE937](#) [MCP6V16UT-E/OT](#) [MCP6V17T-E/MS](#) [MCP6V19T-E/ST](#) [SCY6358ADR2G](#) [NCS20282FCTTAG](#) [LM4565FVT-GE2](#)
[EL5420CRZ-T7A](#) [TSV772IQ2T](#) [TSV792IYST](#) [NJM2100M-TE1](#) [COS2262MR](#) [COS2252MR](#) [COS5532SRB](#) [COS2272MR](#) [LMV358MR](#)
[COS6002MR](#) [LMV358SR](#) [LM358SR](#) [RC4580MM/TR](#) [HGV8544M/TR](#) [HGV8541M/TR](#) [HGV8634M/TR](#) [HGV8542M/TR](#)
[HGV8544MT/TR](#)