

---

## Zero-Drift, Rail-to-Rail I/O CMOS Operational Amplifiers

---

### Features

- **Low Offset Voltage: 20 $\mu$ V**
- **Input Offset Drift: 0.03 $\mu$ V/ $^{\circ}$ C**
- **High Gain Bandwidth Product: 4.3MHz**
- **Rail-to-Rail Input and Output**
- **High Gain, CMRR, PSRR:120dB**
- **High Slew Rate: 2.5V/ $\mu$ s**
- **Low Noise: 0.93uVp-p (0.01~10Hz)**
- **Low Power Consumption: 650 $\mu$ A /op amp**
- **Overload Recovery Time:1us**
- **Low Supply Voltage: +2.7 V to +5.5 V**
- **No External Capacitors Required**
- **Extended Temperature: -40 $^{\circ}$ C to +125 $^{\circ}$ C**

### Applications

- **Temperature Sensors**
- **Medical/Industrial Instrumentation**
- **Pressure Sensors**
- **Battery-Powered Instrumentation**
- **Active Filtering**
- **Weight Scale Sensor**
- **Strain Gage Amplifiers**
- **Power Converter/Inverter**

### Description

The RS8557,RS8558,RS8559 series of CMOS operational amplifiers use auto-zero techniques to simultaneously provide very low offset voltage (50 $\mu$ V max) and near-zero drift over time and temperature. This family of amplifiers has ultralow noise, offset and power.

This miniature, high-precision operational amplifiers offset high input impedance and rail-to-rail input and rail-to-rail output swing. With high gain-bandwidth product of 4.3MHz and slew rate of 2.5V/ $\mu$ s. Single or dual supplies as low as +2.7V ( $\pm$ 1.35V) and up to +5.5V ( $\pm$ 2.75V) may be used.

The RS8557/RS8558/RS8559 are specified for the extended industrial and automotive temperature range (-40 $^{\circ}$ C to 125 $^{\circ}$ C). The RS8557 single amplifier is available in 5-lead SOT23, 8-lead MSOP8 and 8-lead SOIC packages, The RS8558 dual amplifier is available in 8-lead SOIC and 8-lead MSOP narrow surface mount packages, The RS8559 quad amplifier is available in 14-lead SOIC and 14-lead narrow TSSOP packages.

# PIN CONFIGURATIONS

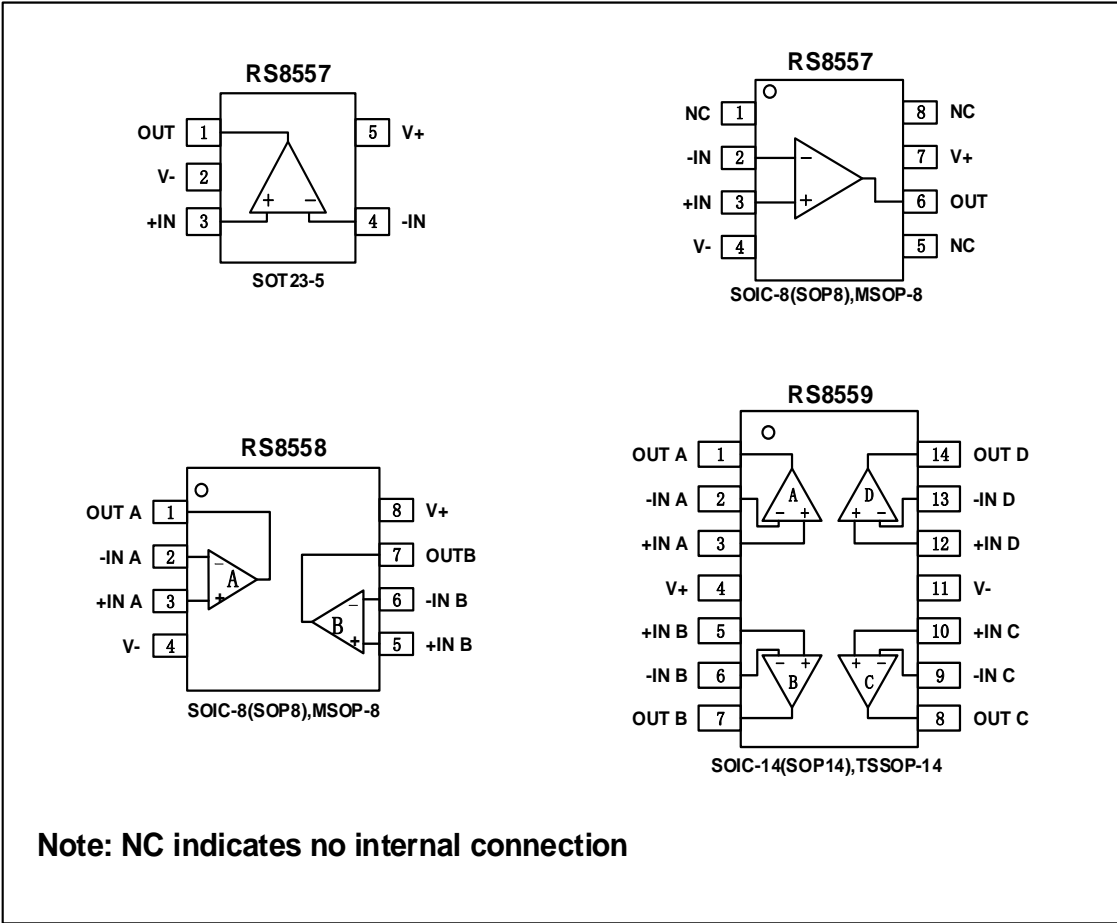

**ABSOLUTE MAXIMUM RATINGS <sup>(1)</sup>**

Supply Voltage, V+ to V-.....	7.0V
Input Terminals, Voltage <sup>(2)</sup> .....	- 0.5 to (V+) + 0.5V
Current <sup>(2)</sup> .....	±10mA
Storage Temperature .....	-65°C to +150°C
Operating Temperature .....	-40°C to +125°C
Junction Temperature.....	150°C
Package Thermal Resistance @ T <sub>A</sub> = +25°C	
SOT23-5, SOT23-6.....	200°C/W
MSOP-10, SOIC-8 .....	150°C/W
SOIC-14, TSSOP-14.....	100°C/W
Lead Temperature (Soldering, 10s) .....	260°C
ESD Susceptibility	
HBM .....	5000V
MM .....	400V

**ESD SENSITIVITY CAUTION**

ESD damage can range from subtle performance degradation to complete device failure. Precision integrated circuits may be more susceptible to damage because very small parametric changes could cause the device not to meet its published specifications.

(1) Stresses above these ratings may cause permanent damage. Exposure to absolute maximum conditions for extended periods may degrade device reliability. These are stress ratings only, and functional operation of the device at these or any other conditions beyond those specified is not implied.

(2) Input terminals are diode-clamped to the power-supply rails. Input signals that can swing more than 0.5V beyond the supply rails should be current-limited to 10mA or less.

**PACKAGE/ORDERING INFORMATION**

PRODUCT	ORDERING NUMBER	TEMPRANGE	PACKAGE	PACKAGE MARKING	TRANSPORT MEDIA, QUANTITY
RS8557	RS8557XF	-40°C ~125°C	SOT23-5	8557	Reel,3000
	RS8557XK	-40°C ~125°C	SOIC-8(SOP8)	RS8557	Reel,2500
	RS8557XM	-40°C ~125°C	MSOP-8	RS8557	Reel,3000
RS8558	RS8558XK	-40°C ~125°C	SOIC-8(SOP8)	RS8558	Reel,2500
	RS8558XM	-40°C ~125°C	MSOP-8	RS8558	Reel,3000
RS8559	RS8559XP	-40°C ~125°C	SOIC-14(SOP14)	RS8559	Reel,2500
	RS8559XQ	-40°C ~125°C	TSSOP-14	RS8559	Reel,3000

**ELECTRICAL CHARACTERISTICS**
**Boldface** limits apply over the specified temperature range,  $T_A = -40^{\circ}\text{C}$  to  $+125^{\circ}\text{C}$ .

 (At  $T_A = +25^{\circ}\text{C}$ ,  $V_S=5\text{V}$ ,  $R_L = 10\text{k}\Omega$  connected to  $V_S/2$ , and  $V_{OUT} = V_S/2$ , unless otherwise noted.)

PARAMETER	CONDITION	RS8557,RS8558, RS8559			UNIT
		MIN	TYP	MAX	
<b>OFFSET VOLTAGE</b>					
Input Offset Voltage $V_{os}$	$V_{CM} = V_S/2$		20	50	$\mu\text{V}$
<b>VS Temperature</b> $dV_{os}/dT$		<b>105</b>	<b>0.03</b>	<b>0.2</b>	$\mu\text{V}/^{\circ}\text{C}$
<b>VS Power Supply</b> <b>PSRR</b>	<b><math>V_S = +2.7\text{V}</math> to <math>+5.5\text{V}</math>, <math>V_{CM} = 0</math></b>	<b>105</b>	<b>120</b>		<b>dB</b>
Channel Separation, dc			0.13		$\mu\text{V}/\text{V}$
<b>INPUT BIAS CURRENT</b>					
Input Bias Current $I_B$	$V_{CM} = V_S/2$		50		$\text{pA}$
Input Offset Current $I_{os}$			10		$\text{pA}$
<b>NOISE PERFORMANCE</b>					
Input Voltage Noise $e_{n,p-p}$	$f=0.01\text{Hz}$ to $10\text{Hz}$		0.93		$\mu\text{V}_{pp}$
Input Voltage Noise $e_{n,p-p}$	$f=0.01\text{Hz}$ to $1\text{Hz}$		0.32		$\mu\text{V}_{pp}$
Input Voltage Noise Density $e_n$	$f=1\text{KHz}$		45		$\text{nV}/\sqrt{\text{Hz}}$
Input Current Noise Density $i_n$	$f=10\text{Hz}$		2.3		$\text{fA}/\sqrt{\text{Hz}}$
<b>INPUT VOLTAGE RANGE</b>					
Common-Mode Voltage Range $V_{CM}$		$(V_-)-0.2$		$(V_+)+0.2$	$\text{V}$
<b>Common-Mode Rejection Ratio</b> <b>CMRR</b>	<b><math>(V_-) - 0.2\text{V} &lt; V_{CM} &lt; (V_+) + 0.2\text{V}</math></b>	<b>105</b>	<b>120</b>		<b>dB</b>
<b>INPUT CAPACITANCE</b>					
Differential			1		$\text{pF}$
Common-Mode			5		$\text{pF}$
<b>OPEN-LOOP GAIN</b>					
<b>Open-Loop Voltage Gain</b> <b><math>A_{OL}</math></b>	<b><math>R_L=10\text{K}\Omega</math>, <math>V_O=0.3\text{V}</math> to <math>4.7\text{V}</math>, <math>-40^{\circ}\text{C}</math>~<math>125^{\circ}\text{C}</math></b>	<b>105</b>	<b>120</b>		<b>dB</b>
<b>DYNAMIC PERFORMANCE</b>					
Slew Rate <b>SR</b>	$G=+1$		2.5		$\text{V}/\mu\text{s}$
Gain-Bandwidth Product <b>GBW</b>			4.3		$\text{MHz}$
Overload Recovery Time			1		$\mu\text{s}$
<b>OUTPUT CHARACTERISTICS</b>					
Output Voltage High $V_{OH}$	$R_L=100\text{K}\Omega$ to GND	4.99	4.998		$\text{V}$
	$R_L=10\text{K}\Omega$ to GND	4.95	4.98		$\text{V}$
Output Voltage Low $V_{OL}$	$R_L=100\text{K}\Omega$ to $V_+$		1	10	$\text{mV}$
	$R_L=10\text{K}\Omega$ to $V_+$		10	30	$\text{mV}$
Short-Circuit Current $I_{SC}$			48		$\text{mA}$
<b>POWER SUOOLY</b>					
Operating Voltage Range		2.7		5.5	$\text{V}$
Quiescent Current/ Amplifier $I_Q$			650	900	$\mu\text{A}$

### TYPICAL CHARACTERISTICS

At  $T_A = +25^\circ\text{C}$ ,  $V_S=5\text{V}$ ,  $R_L = 10\text{k}\Omega$  connected to  $V_S/2$ ,  $V_{OUT} = V_S/2$ , unless otherwise noted.

OFFSET VOLTAGE PRODUCTION DISTRIBUTION

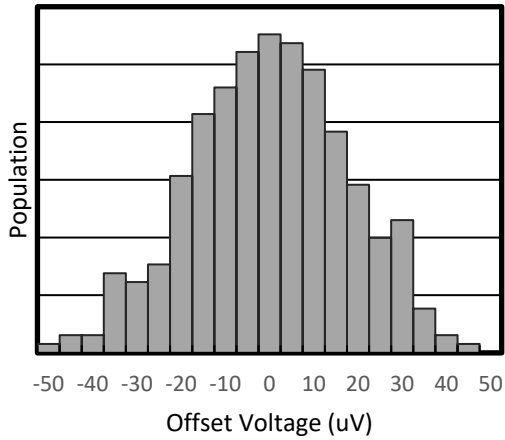

OFFSET VOLTAGE DRIFT PRODUCTION DISTRIBUTION

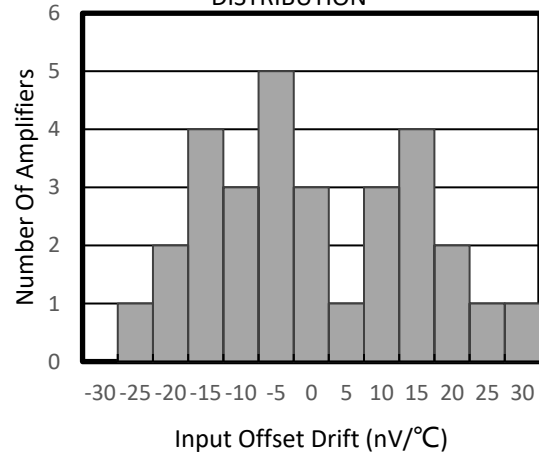

OPEN-LOOP GAIN AND PHASE vs FREQUENCY

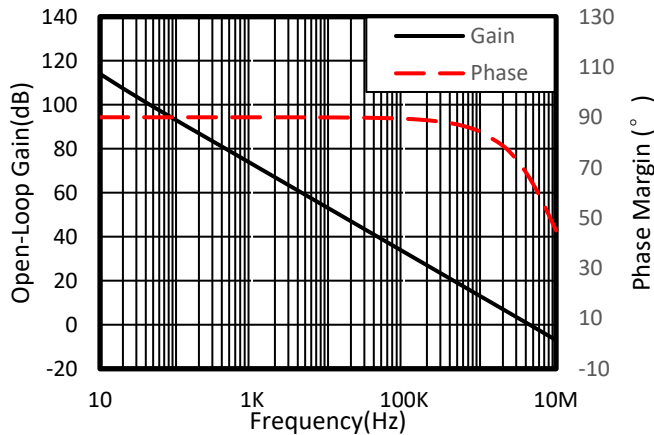

INPUT BIAS CURRENT vs TEMPERATURE

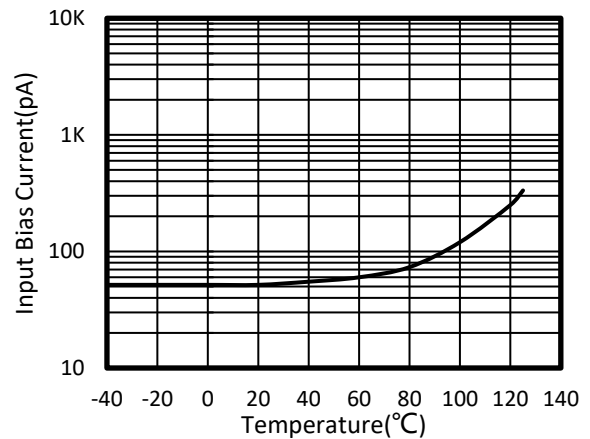

POWER-SUPPLY REJECTION RATIO vs FREQUENCY

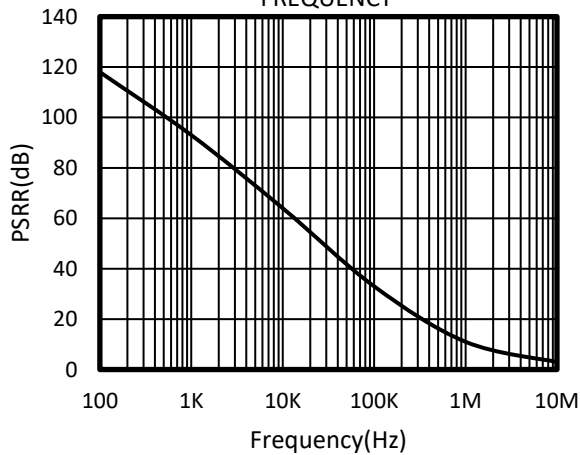

COMMON-MODE REJECTION RATIO vs FREQUENCY

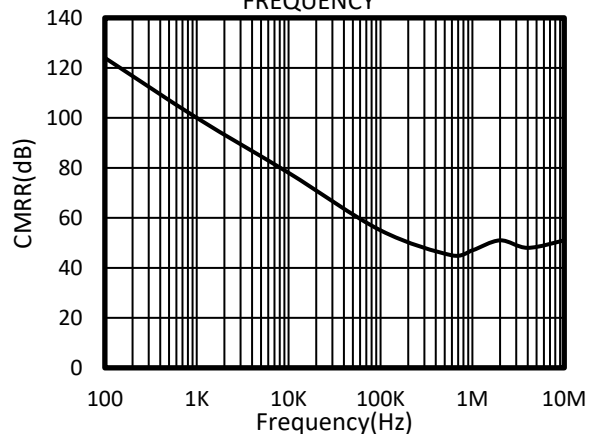

### TYPICAL CHARACTERISTICS

At  $T_A = +25^\circ\text{C}$ ,  $V_S = 5\text{V}$ ,  $R_L = 10\text{k}\Omega$  connected to  $V_S/2$ ,  $V_{OUT} = V_S/2$ , unless otherwise noted.

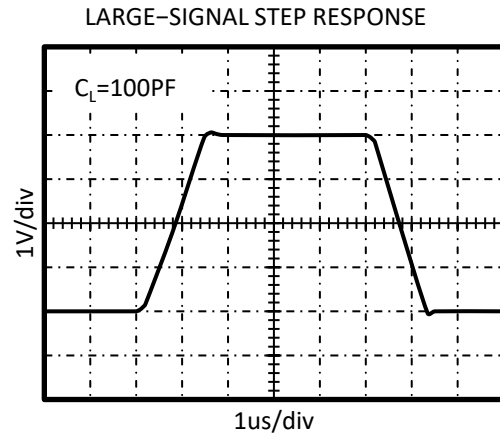
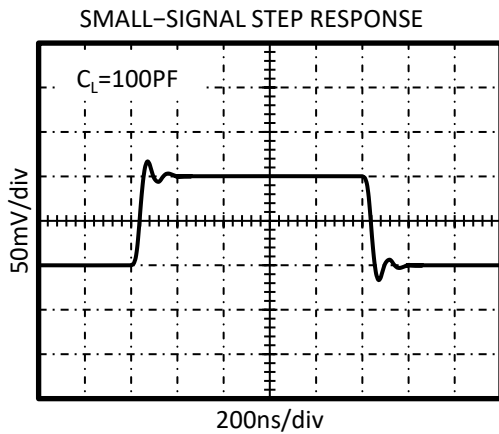
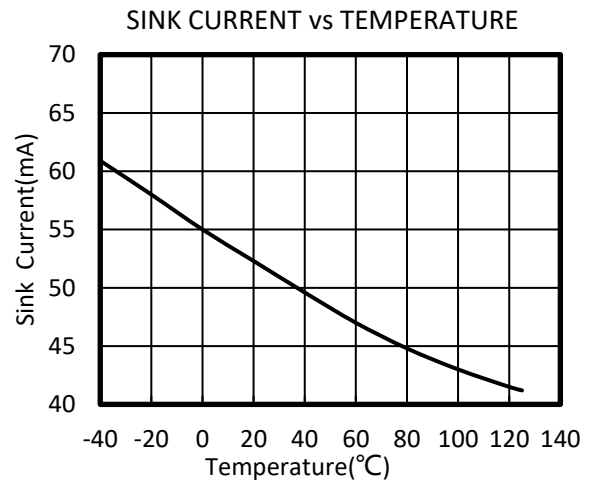
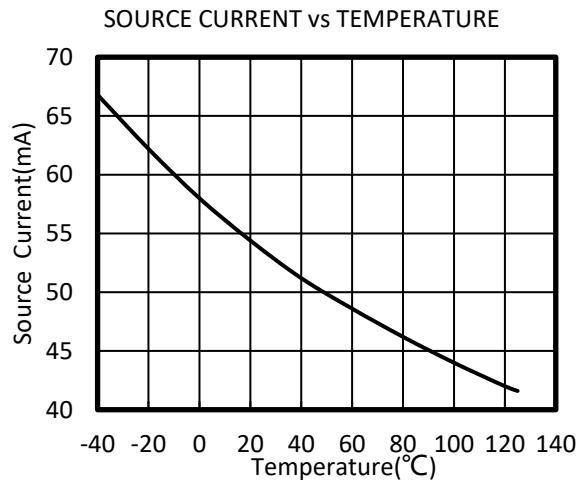
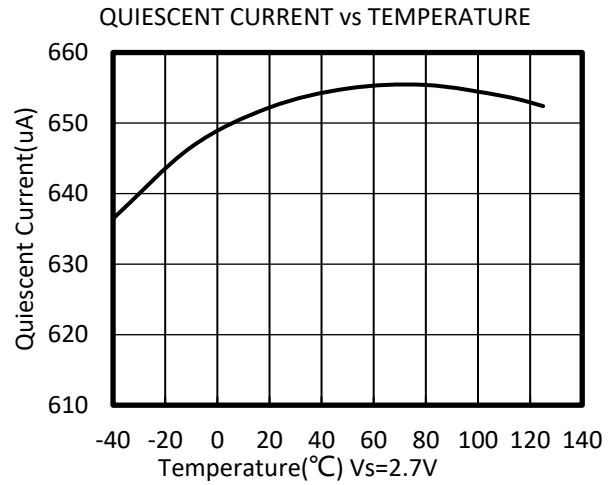
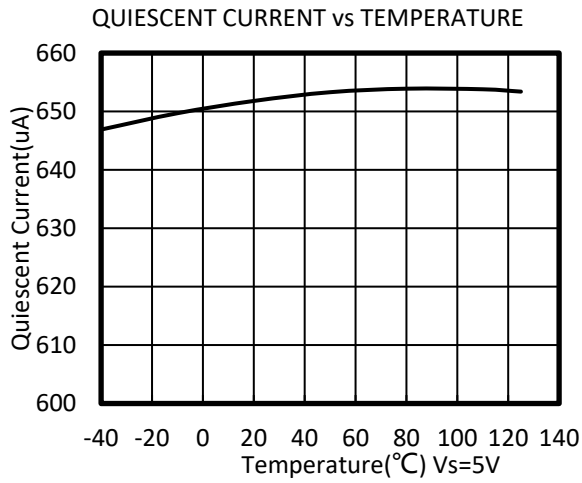

### TYPICAL CHARACTERISTICS

At  $T_A = +25^\circ\text{C}$ ,  $V_S = 5\text{V}$ ,  $R_L = 10\text{k}\Omega$  connected to  $V_S/2$ ,  $V_{OUT} = V_S/2$ , unless otherwise noted.

POSITIVE OVERVOLTAGE RECOVERY

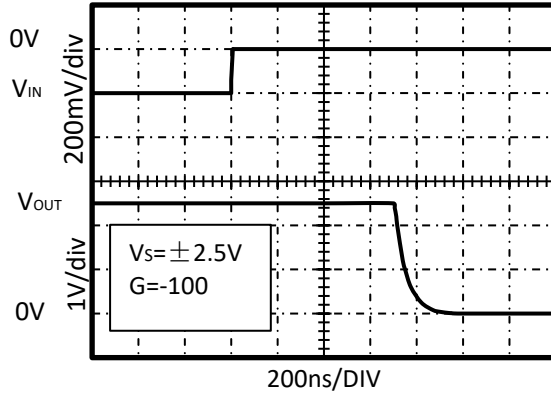

NEGATIVE OVERVOLTAGE RECOVERY

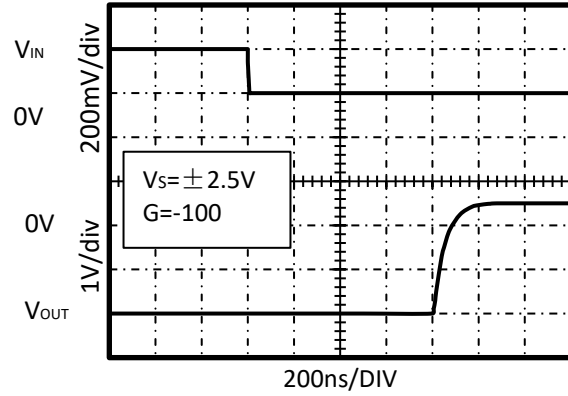

0.01Hz TO 10Hz NOISE AT  $V_S = 5\text{V}$

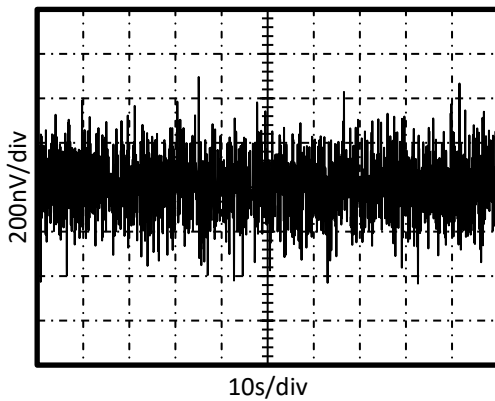

0.01Hz TO 10Hz NOISE AT  $V_S = 2.7\text{V}$

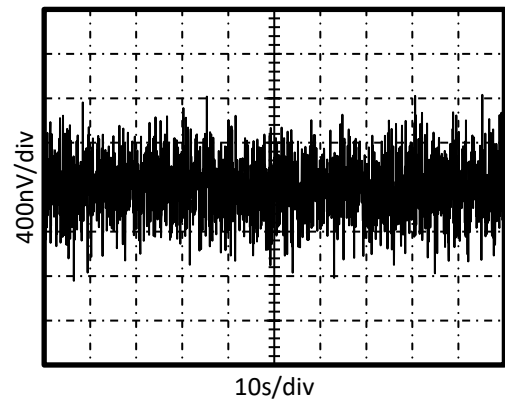

0.01Hz TO 1Hz NOISE AT  $V_S = 5\text{V}$

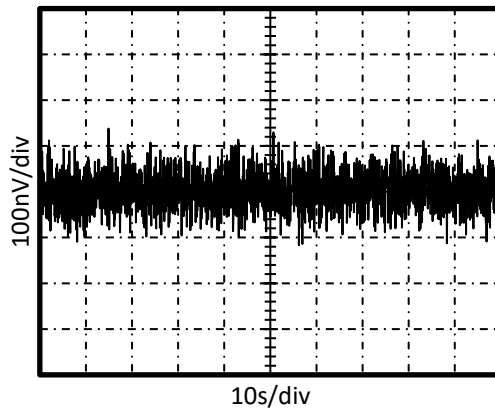

0.01Hz TO 1Hz NOISE AT  $V_S = 2.7\text{V}$

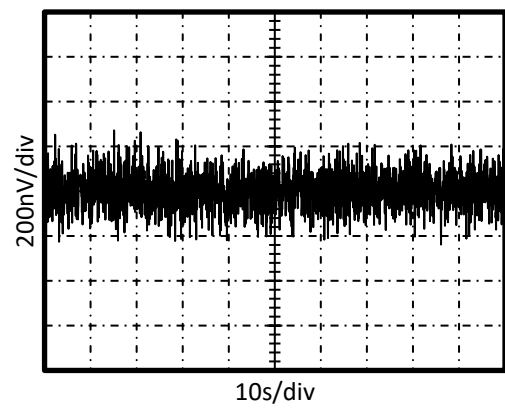

## APPLICATION NOTES

The RS8557, RS8558, RS8559 series op amps are unity-gain stable and free from unexpected output phase reversal. They use auto-zeroing techniques to provide low offset voltage and very low drift over time and temperature.

Good layout practice mandates use of a 0.1 $\mu$ F capacitor placed closely across the supply pins.

For lowest offset voltage and precision performance, circuit layout and mechanical conditions should be optimized. Avoid temperature gradients that create thermoelectric (Seebeck) effects in thermocouple junctions formed from connecting dissimilar conductors. These thermally-generated potentials can be made to cancel by assuring that they are equal on both input terminals.

- Use low thermoelectric-coefficient connections (avoid dissimilar metals).
- Thermally isolate components from power supplies or other heat-sources.
- Shield op amp and input circuitry from air currents, such as cooling fans.

Following these guidelines will reduce the likelihood of junctions being at different temperatures, which can cause thermoelectric voltages of 0.1 $\mu$ V/ $^{\circ}$ C or higher, depending on materials used.

## OPERATING VOLTAGE

The RS8557, RS8558, RS8559 series op amps operate over a power-supply range of +2.7V to +5.5V ( $\pm 1.35$ V to  $\pm 2.75$ V). Supply voltages higher than 7V (absolute maximum) can permanently damage the amplifier. Parameters that vary over supply voltage or temperature are shown in the Typical Characteristics section of this data sheet.

## LAYOUT GUIDELINES

Attention to good layout practices is always recommended. Keep traces short. When possible, use a PCB ground plane with surface-mount components placed as close to the device pins as possible. Place a 0.1 $\mu$ F capacitor closely across the supply pins. These guidelines should be applied throughout the analog circuit to improve performance and provide benefits such as reducing the EMI (electromagnetic-interference) susceptibility.

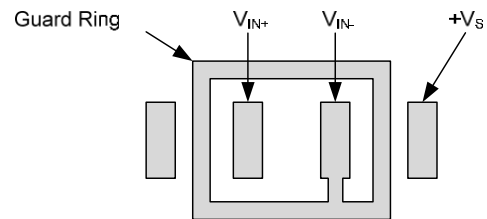
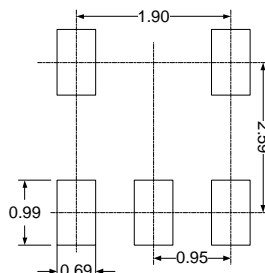
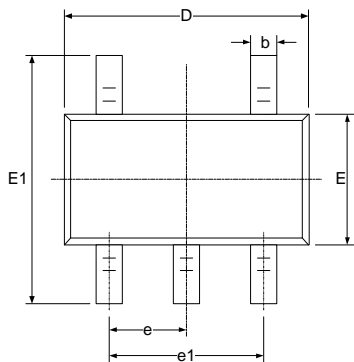

**Figure 1. The Layout of Guard Ring**



# PACKAGE OUTLINE DIMENSIONS

## SOT23-5



RECOMMENDED LAND PATTERN (Unit: mm)

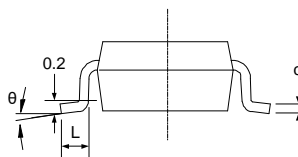
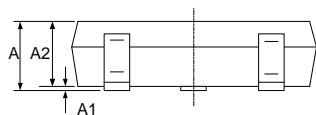

Symbol	Dimensions In Millimeters		Dimensions In Inches	
	Min	Max	Min	Max
A	1.050	1.250	0.041	0.049
A1	0.000	0.100	0.000	0.004
A2	1.050	1.150	0.041	0.045
b	0.300	0.500	0.012	0.020
c	0.100	0.200	0.004	0.008
D	2.820	3.020	0.111	0.119
E	1.500	1.700	0.059	0.067
E1	2.650	2.950	0.104	0.116
e	0.950(BSC)		0.037(BSC)	
e1	1.800	2.000	0.071	0.079
L	0.300	0.600	0.012	0.024
$\theta$	0°	8°	0°	8°

# MSOP-8

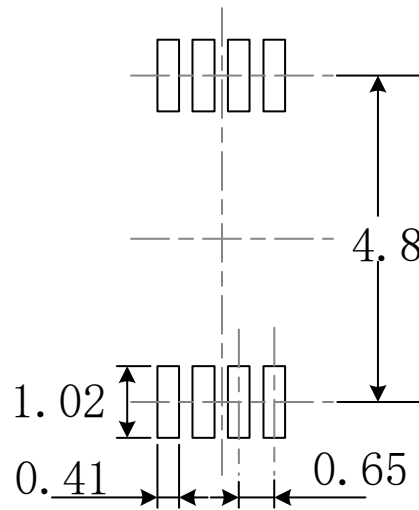
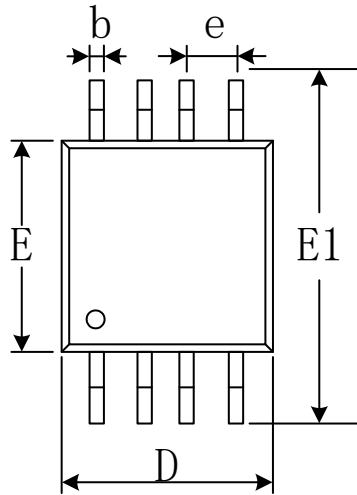

RECOMMENDED LAND PATTERN (Unit: mm)

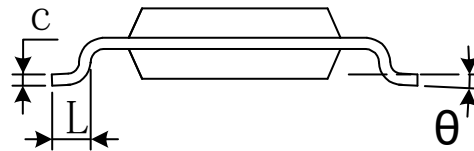
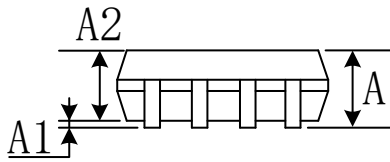

Symbol	Dimensions In Millimeters		Dimensions In Inches	
	Min	Max	Min	Max
A	0.820	1.100	0.032	0.043
A1	0.020	0.150	0.001	0.006
A2	0.750	0.950	0.030	0.037
b	0.250	0.380	0.010	0.015
c	0.090	0.230	0.004	0.009
D	2.900	3.100	0.114	0.122
e	0.650(BSC)		0.026(BSC)	
E	2.900	3.100	0.114	0.122
E1	4.750	5.050	0.187	0.199
L	0.400	0.800	0.016	0.031
$\theta$	0°	6°	0°	6°

# TSSOP-14

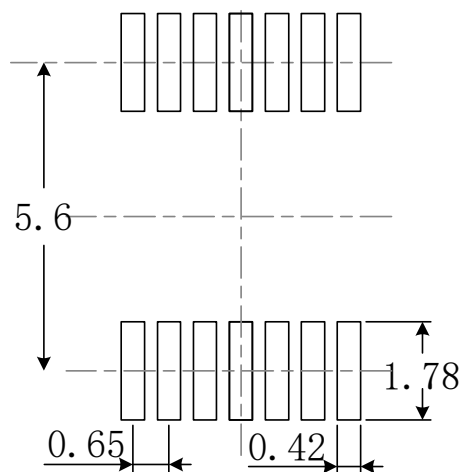
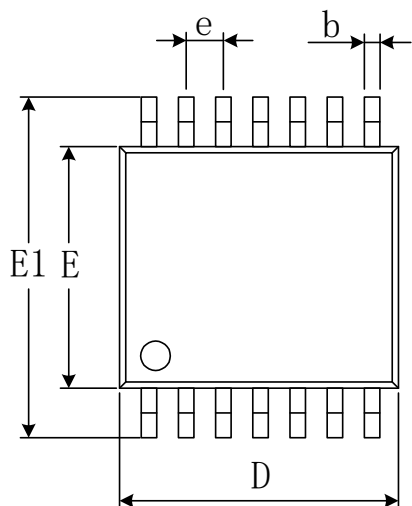
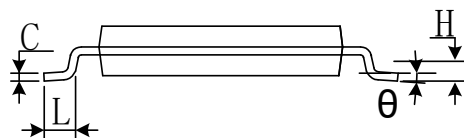
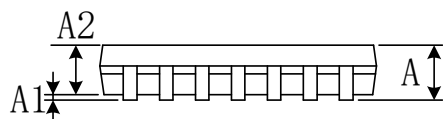

**RECOMMENDED LAND PATTERN** (Unit: mm)

Symbol	Dimensions In Millimeters		Dimensions In Inches	
	Min	Max	Min	Max
A		1.200		0.047
A1	0.050	0.150	0.002	0.006
A2	0.800	1.050	0.031	0.041
b	0.190	0.300	0.007	0.012
c	0.090	0.200	0.004	0.008
D	4.860	5.100	0.191	0.201
E	4.300	4.500	0.169	0.177
E1	6.250	6.550	0.246	0.258
e	0.650(BSC)		0.026(BSC)	
L	0.500	0.700	0.020	0.028
H	0.25(TYP)		0.01(TYP)	
$\theta$	1°	7°	1°	7°

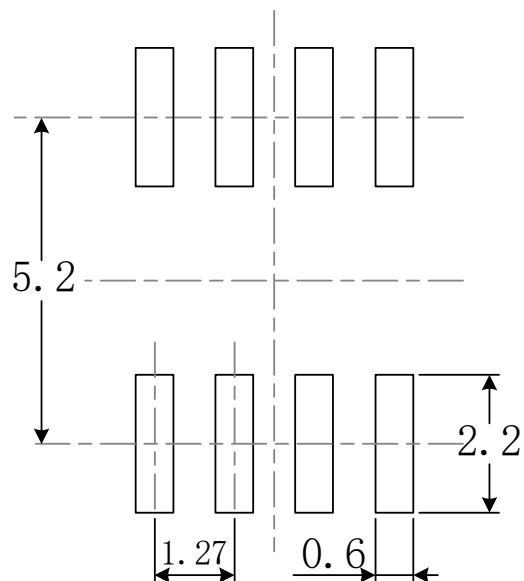
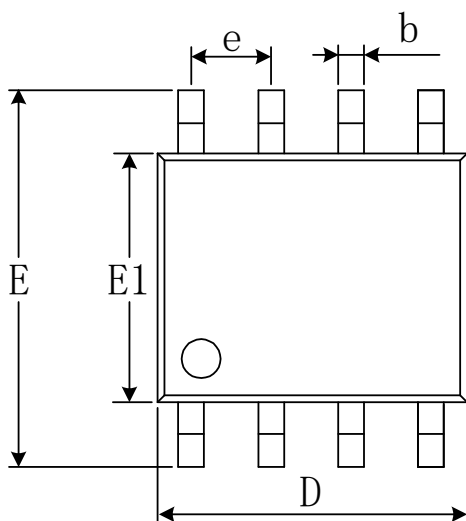
# SOIC-8(SOP8)

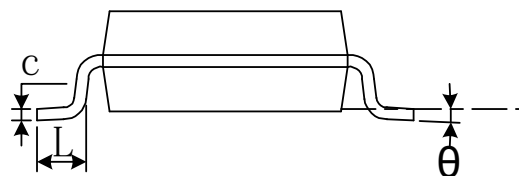
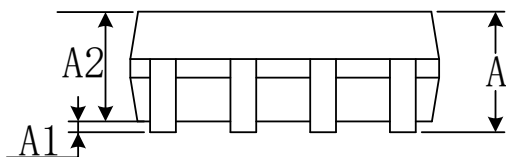

RECOMMENDED LAND PATTERN (Unit: mm)



Symbol	Dimensions In Millimeters		Dimensions In Inches	
	Min	Max	Min	Max
A	1.350	1.750	0.053	0.069
A1	0.100	0.250	0.004	0.010
A2	1.350	1.550	0.053	0.061
b	0.330	0.510	0.013	0.020
c	0.170	0.250	0.007	0.010
D	4.800	5.000	0.189	0.197
e	1.270(BSC)		0.050(BSC)	
E	5.800	6.200	0.228	0.244
E1	3.800	4.000	0.150	0.157
L	0.400	1.270	0.016	0.050
$\theta$	0°	8°	0°	8°

# SOIC-14(SOP14)

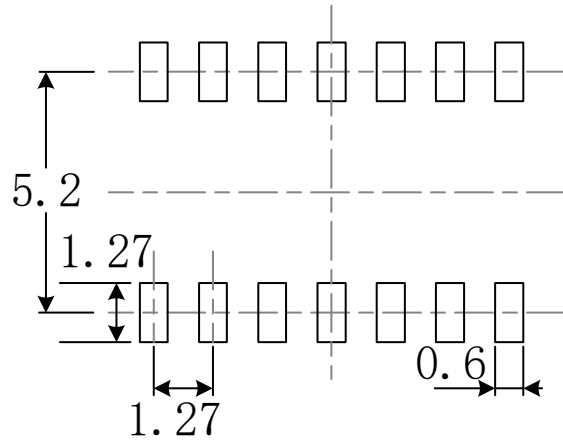
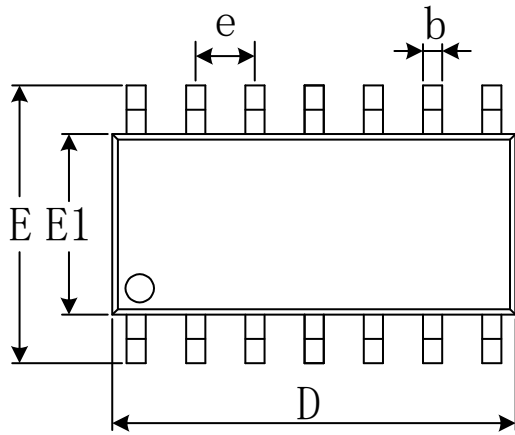

RECOMMENDED LAND PATTERN (Unit: mm)

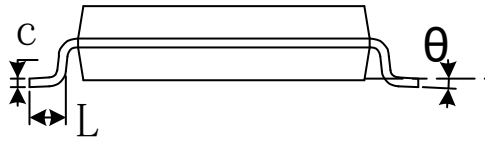
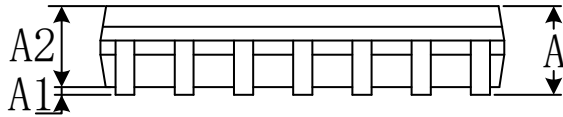

Symbol	Dimensions In Millimeters		Dimensions In Inches	
	Min	Max	Min	Max
A	1.350	1.750	0.053	0.069
A1	0.100	0.250	0.004	0.010
A2	1.350	1.550	0.053	0.061
b	0.310	0.510	0.012	0.020
c	0.100	0.250	0.004	0.010
D	8.450	8.850	0.333	0.348
e	1.270(BSC)		0.050(BSC)	
E	5.800	6.200	0.228	0.244
E1	3.800	4.000	0.150	0.157
L	0.400	1.270	0.016	0.050
$\theta$	0°	8°	0°	8°

## X-ON Electronics

Largest Supplier of Electrical and Electronic Components

*Click to view similar products for [Precision Amplifiers](#) category:*

*Click to view products by [RUNIC](#) manufacturer:*

Other Similar products are found below :

[561681F](#) [NCS21802DMR2G](#) [NCS20166SN2T1G](#) [NCV21802DMR2G](#) [NCS21802MUTBG](#) [OPA209AIDR](#) [TLC27L7CP](#) [TLV2473CDR](#)  
[LMP2234AMA/NOPB](#) [LMP7707MA/NOPB](#) [LMP2231AMAE/NOPB](#) [LMP2234AMTE/NOPB](#) [LMP8672MA/NOPB](#) [LMC6022IM/NOPB](#)  
[LMC6024IM/NOPB](#) [LMC6081IMX/NOPB](#) [LMP2011MA/NOPB](#) [LMP2231AMFE/NOPB](#) [LMP2232BMA/NOPB](#) [LMP2234AMAE/NOPB](#)  
[LMP7715MFE/NOPB](#) [LMP7717MAE/NOPB](#) [LMV2011MA/NOPB](#) [LT1013DDR](#) [TL034ACDR](#) [TLC2201AMDG4](#) [MCP6061T-E/MNY](#)  
[TS507IYLT](#) [TS9222IYDT](#) [OA2ZHA22Q](#) [TLV2472QDRQ1](#) [TLC4502IDR](#) [TLC27M2ACP](#) [TLC2652Q-8DG4](#) [OPA2107APG4](#) [TL054AIDR](#)  
[AD8619WARZ-R7](#) [TLC272CD](#) [LT1672IMS8#PBF](#) [LT1996IDD#PBF](#) [LT6010CDD#PBF](#) [LTC6241IDD#PBF](#) [AD8572ARUZ-REEL](#)  
[LT1077CN8#PBF](#) [LTC1050CN8#PBF](#) [OP777ARMZ-REEL](#) [LT6220IS5#TRMPBF](#) [LT6011IDD#PBF](#) [LT1078IN8#PBF](#) [LT1211IS8#PBF](#)