

Zero-Drift, Rail-to-Rail I/O CMOS Operational Amplifiers

FEATURES

- **Low Offset Voltage:** $\pm 3\mu\text{V}$ (TYP)
- **Input Offset Drift:** $\pm 0.03\mu\text{V}/^\circ\text{C}$
- **High Gain Bandwidth Product:** 4.3MHz
- **Rail-to-Rail Input and Output**
- **High Gain, CMRR, PSRR:** 120dB
- **High Slew Rate:** 2.5V/ μs
- **Low Noise:** 0.93uVp-p (0.01Hz~ 10Hz)
- **Low Power Consumption:** 650 μA /op amp
- **Overload Recovery Time:** 1us
- **Low Supply Voltage:** +2.7V to +5.5V
- **No External Capacitors Required**
- **Extended Temperature:** -40°C to +125°C

APPLICATIONS

- **Temperature Sensors**
- **Medical/Industrial Instrumentation**
- **Pressure Sensors**
- **Battery-Powered Instrumentation**
- **Active Filtering**
- **Weight Scale Sensor**
- **Strain Gage Amplifiers**
- **Power Converter/Inverter**

DESCRIPTION

The RS8557, RS8558, RS8559 series of CMOS operational amplifiers use auto-zero techniques to simultaneously provide very low offset voltage (20 μV max) and near-zero drift over time and temperature. This family of amplifiers has ultralow noise, offset and power.

This miniature, high-precision operational amplifiers offset high input impedance and rail-to-rail input and rail-to-rail output swing. With high gain-bandwidth product of 4.3MHz and slew rate of 2.5V/ μs .

Single or dual supplies as low as +2.7V ($\pm 1.35\text{V}$) and up to +5.5V ($\pm 2.75\text{V}$) may be used.

The RS8557/RS8558/RS8559 are specified for the extended industrial and automotive temperature range (-40°C to 125°C). The RS8557 single amplifier is available in 5-lead SOT23, 8-lead MSOP8 and 8-lead SOIC packages, The RS8558 dual amplifier is available in 8-lead SOIC and 8-lead MSOP narrow surface mount packages, the RS8559 quad amplifier is available in 14-lead SOIC and 14-lead narrow TSSOP packages.

Device Information ⁽¹⁾

| PART NUMBER | PACKAGE(PIN) | BODY SIZE (NOM) |
|-------------|-----------------|-----------------|
| RS8557 | SOT23-5 | 2.90mmx1.60mm |
| | SOIC-8(SOP8) | 4.90mmx3.90mm |
| | MSOP-8 | 3.00mmx3.00mm |
| RS8558 | SOIC-8(SOP8) | 4.90mmx3.90mm |
| | MSOP-8 | 3.00mmx3.00mm |
| RS8559 | SOIC-14 (SOP14) | 8.65mmx3.90mm |
| | TSSOP-14 | 5.00mmx4.40mm |

(1) For all available packages, see the orderable addendum at the end of the data sheet.

Revision History

Note: Page numbers for previous revisions may differ from page numbers in the current version.

| Version | Change Date | Change Item |
|---------|-------------|-------------------------------------|
| C.1 | 2021/11/05 | Update Package Qty on Page 6@RevB.3 |

Pin Configuration and Functions (Top View)

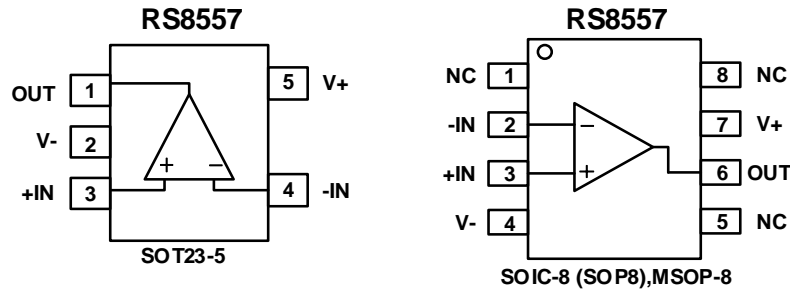

Pin Description

| NAME | PIN | | I/O | DESCRIPTION |
|------|---------|----------------------|-----|---|
| | RS8557 | RS8557 | | |
| | SOT23-5 | SOIC-8 (SOP8)/ MSOP8 | | |
| -IN | 4 | 2 | I | Negative (inverting) input |
| +IN | 3 | 3 | I | Positive (noninverting) input |
| NC | - | 1,5,8 | - | No internal connection (can be left floating) |
| OUT | 1 | 6 | O | Output |
| V- | 2 | 4 | - | Negative (lowest) power supply |
| V+ | 5 | 7 | - | Positive (highest) power supply |

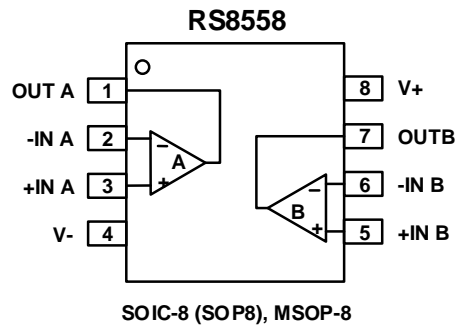

Pin Description

| NAME | PIN | I/O | DESCRIPTION |
|------|----------------------|-----|---------------------------------|
| | SOIC-8 (SOP8)/ MSOP8 | | |
| -INA | 2 | I | Inverting input, channel A |
| +INA | 3 | I | Noninverting input, channel A |
| -INB | 6 | I | Inverting input, channel B |
| +INB | 5 | I | Noninverting input, channel B |
| OUTA | 1 | O | Output, channel A |
| OUTB | 7 | O | Output, channel B |
| V- | 4 | - | Negative (lowest) power supply |
| V+ | 8 | - | Positive (highest) power supply |

Pin Configuration and Functions (Top View)

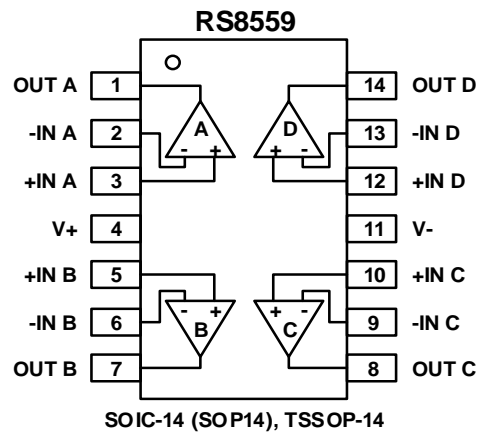

Pin Description

| NAME | PIN | I/O | DESCRIPTION |
|------|---------------------------|-----|---------------------------------|
| | SOIC-14 (SOP14)/ TSSOP-14 | | |
| -INA | 2 | I | Inverting input, channel A |
| +INA | 3 | I | Noninverting input, channel A |
| -INB | 6 | I | Inverting input, channel B |
| +INB | 5 | I | Noninverting input, channel B |
| -INC | 9 | I | Inverting input, channel C |
| +INC | 10 | I | Noninverting input, channel C |
| -IND | 13 | I | Inverting input, channel D |
| +IND | 12 | I | Noninverting input, channel D |
| OUTA | 1 | O | Output, channel A |
| OUTB | 7 | O | Output, channel B |
| OUTC | 8 | O | Output, channel C |
| OUTD | 14 | O | Output, channel D |
| V- | 11 | - | Negative (lowest) power supply |
| V+ | 4 | - | Positive (highest) power supply |

SPECIFICATIONS

Absolute Maximum Ratings

Over operating free-air temperature range (unless otherwise noted) ⁽¹⁾

| | | MIN | MAX | UNIT |
|-------------|-------------------------------------|------------|-----------|------|
| Voltage | Supply, $V_S = (V+) - (V-)$ | | 7 | V |
| | Signal input pin ⁽²⁾ | (V-) -0.5 | (V+) +0.5 | |
| | Signal output pin ⁽³⁾ | (V-) -0.5 | (V+) +0.5 | |
| Current | Signal input pin ⁽²⁾ | -10 | 10 | mA |
| | Signal output pin ⁽³⁾ | -55 | 55 | mA |
| | Output short-circuit ⁽⁴⁾ | Continuous | | |
| Temperature | Operating range, T_A | -40 | 125 | °C |
| | Junction, T_J | | 150 | |
| | Storage, T_{stg} | -65 | 150 | |

(1) Stresses above these ratings may cause permanent damage. Exposure to absolute maximum conditions for extended periods may degrade device reliability. These are stress ratings only, and functional operation of the device at these or any other conditions beyond those specified is not implied.

(2) Input terminals are diode-clamped to the power-supply rails. Input signals that can swing more than 0.5V beyond the supply rails should be current-limited to 10mA or less.

(3) Output terminals are diode-clamped to the power-supply rails. Output signals that can swing more than 0.5V beyond the supply rails should be current-limited to ± 55 mA or less.

(4) Short-circuit to ground, one amplifier per package.

ESD Ratings

| | | VALUE | UNIT |
|-------------------------------------|------------------------|------------|------|
| $V_{(ESD)}$ Electrostatic discharge | Human-body model (HBM) | ± 5000 | V |
| | Machine Model (MM) | ± 400 | |

Recommended Operating Conditions

Over operating free-air temperature range (unless otherwise noted)

| | | MIN | NOM | MAX | UNIT |
|-------------------------------------|---------------|------------|-----|------------|------|
| Supply voltage, $V_S = (V+) - (V-)$ | Single-supply | 2.7 | | 5.5 | V |
| | Dual-supply | ± 1.35 | | ± 2.75 | |
| Specified temperature | | -40 | | 125 | °C |

Thermal Information: RS8557

| THERMAL METRIC | | RS8557 | | | UNIT |
|-----------------------|--|---------|--------|--------|------|
| | | 5PINS | 8PINS | | |
| | | SOT23-5 | SOIC-8 | MSOP-8 | |
| $R_{\theta JA}$ | Junction-to-ambient thermal resistance | 273.8 | 116 | 165 | °C/W |
| $R_{\theta JC (top)}$ | Junction-to-case (top) thermal resistance | 126.8 | 60 | 53 | °C/W |
| $R_{\theta JB}$ | Junction-to-board thermal resistance | 85.9 | 56 | 87 | °C/W |
| Ψ_{JT} | Junction-to-top characterization parameter | 10.9 | 12.8 | 4.9 | °C/W |
| Ψ_{JB} | Junction-to-board characterization parameter | 84.9 | 98.3 | 85 | °C/W |
| $R_{\theta JC (bot)}$ | Junction-to-case (bottom) thermal resistance | N/A | N/A | N/A | °C/W |

Thermal Information: RS8558

| THERMAL METRIC | | RS8558 | | UNIT |
|------------------------|--|--------|-------|------|
| | | 8PINS | | |
| | | SOIC-8 | MSOP8 | |
| R _{θJA} | Junction-to-ambient thermal resistance | 116 | 165 | °C/W |
| R _{θJC (top)} | Junction-to-case (top) thermal resistance | 60 | 53 | °C/W |
| R _{θJB} | Junction-to-board thermal resistance | 56 | 87 | °C/W |
| Ψ _{JT} | Junction-to-top characterization parameter | 12.8 | 4.9 | °C/W |
| Ψ _{JB} | Junction-to-board characterization parameter | 98.3 | 85 | °C/W |
| R _{θJC (bot)} | Junction-to-case (bottom) thermal resistance | N/A | N/A | °C/W |

Thermal Information: RS8559

| THERMAL METRIC | | RS8559 | | UNIT |
|------------------------|--|---------|----------|------|
| | | 14PINS | | |
| | | SOIC-14 | TSSOP-14 | |
| R _{θJA} | Junction-to-ambient thermal resistance | 83.8 | 120.8 | °C/W |
| R _{θJC (top)} | Junction-to-case (top) thermal resistance | 70.7 | 34.3 | °C/W |
| R _{θJB} | Junction-to-board thermal resistance | 59.5 | 62.8 | °C/W |
| Ψ _{JT} | Junction-to-top characterization parameter | 11.6 | 1 | °C/W |
| Ψ _{JB} | Junction-to-board characterization parameter | 37.7 | 56.5 | °C/W |
| R _{θJC (bot)} | Junction-to-case (bottom) thermal resistance | N/A | N/A | °C/W |

PACKAGE/ORDERING INFORMATION

| Orderable Device | Package Type | Pin | Channel | Op Temp (°C) | Device Marking ⁽¹⁾ | Package Qty |
|------------------|-----------------|-----|---------|---------------|-------------------------------|--------------------|
| RS8557XF | SOT23-5 | 5 | 1 | -40°C ~ 125°C | 8557 | Tape and Reel,3000 |
| RS8557XK | SOIC-8 (SOP8) | 8 | 1 | -40°C ~ 125°C | RS8557 | Tape and Reel,4000 |
| RS8557XM | MSOP-8 | 8 | 1 | -40°C ~125°C | RS8557 | Tape and Reel,4000 |
| RS8558XK | SOIC-8 (SOP8) | 8 | 2 | -40°C ~125°C | RS8558 | Tape and Reel,4000 |
| RS8558XM | MSOP-8 | 8 | 2 | -40°C ~125°C | RS8558 | Tape and Reel,4000 |
| RS8559XP | SOIC-14 (SOP14) | 14 | 4 | -40°C ~125°C | RS8559 | Tape and Reel,4000 |
| RS8559XQ | TSSOP-14 | 14 | 4 | -40°C ~125°C | RS8559 | Tape and Reel,4000 |

NOTE:

- (1) There may be additional marking, which relates to the lot trace code information (data code and vendor code), the logo or the environmental category on the device.

ELECTRICAL CHARACTERISTICS

Boldface limits apply over the specified temperature range, $T_A = -40^\circ\text{C}$ to $+125^\circ\text{C}$.

(At $T_A = +25^\circ\text{C}$, $V_S = 5\text{V}$, $R_L = 10\text{k}\Omega$ connected to $V_S/2$, and $V_{OUT} = V_S/2$, unless otherwise noted.)

| PARAMETER | SYMBOL | CONDITION | RS8557, RS8558, RS8559 | | | UNIT |
|------------------------------------|-------------------|---|------------------------|------------|-----------|------------------------------|
| | | | MIN | TYP | MAX | |
| OFFSET VOLTAGE | | | | | | |
| Input Offset Voltage | V_{OS} | $V_{CM} = V_S/2$ | -20 | ± 3 | 20 | μV |
| Input Offset Voltage Average Drift | $V_{OS} T_c$ | | | ± 0.03 | ± 0.2 | $\mu\text{V}/^\circ\text{C}$ |
| Power-Supply Rejection Ratio | PSRR | $V_S = +2.7\text{V}$ to $+5.5\text{V}$, $V_{CM} = 0$ | 105 | 120 | | dB |
| Channel Separation, dc | | | | 0.13 | | $\mu\text{V}/\text{V}$ |
| INPUT BIAS CURRENT | | | | | | |
| Input Bias Current | I_B | $V_{CM} = V_S/2$ | | ± 50 | | pA |
| Input Offset Current | I_{OS} | | | ± 10 | | pA |
| NOISE PERFORMANCE | | | | | | |
| Input Voltage Noise | $e_{n\text{p-p}}$ | $f = 0.01\text{Hz}$ to 10Hz | | 0.93 | | μV_{pp} |
| Input Voltage Noise | $e_{n\text{p-p}}$ | $f = 0.01\text{Hz}$ to 1Hz | | 0.32 | | μV_{pp} |
| Input Voltage Noise Density | e_n | $f = 1\text{KHz}$ | | 45 | | $\text{nV}/\sqrt{\text{Hz}}$ |
| Input Current Noise Density | i_n | $f = 10\text{Hz}$ | | 2.3 | | $\text{fA}/\sqrt{\text{Hz}}$ |
| INPUT VOLTAGE RANGE | | | | | | |
| Common-Mode Voltage Range | V_{CM} | | (V-) -0.2 | | (V+) +0.2 | V |
| Common-Mode Rejection Ratio | CMRR | $(V-) -0.2\text{V} < V_{CM} < (V+) + 0.2\text{V}$ | 105 | 120 | | dB |
| INPUT CAPACITANCE | | | | | | |
| Differential | | | | 1 | | pF |
| Common-Mode | | | | 5 | | pF |
| Open-Loop Gain | | | | | | |
| Open-Loop Voltage Gain | A_{OL} | $R_L = 10\text{k}\Omega$, $V_O = 0.3\text{V}$ to 4.7V , $T_A = -40^\circ\text{C}$ to 125°C | 105 | 120 | | dB |
| DYNAMIC PERFORMANCE | | | | | | |
| Slew Rate | SR | $G = +1$ | | 2.5 | | $\text{V}/\mu\text{s}$ |
| Gain-Bandwidth Product | GBW | | | 4.3 | | MHz |
| Overload Recovery Time | t_{OR} | | | 1 | | μs |
| OUTPUT CHARACTERISTICS | | | | | | |
| Output Voltage High | V_{OH} | $R_L = 100\text{K}\Omega$ to GND | 4.99 | 4.998 | | V |
| | | $R_L = 10\text{K}\Omega$ to GND | 4.95 | 4.98 | | |
| Output Voltage Low | V_{OL} | $R_L = 100\text{K}\Omega$ to V+ | | 1 | 10 | mV |
| | | $R_L = 10\text{K}\Omega$ to V+ | | 10 | 30 | |
| Short-Circuit Current | I_{SC} | | | 48 | | mA |
| POWER SUPPLY | | | | | | |
| Operating Voltage Range | V_S | | 2.7 | | 5.5 | V |
| Quiescent Current/ Amplifier | I_Q | | | 650 | 900 | μA |

TYPICAL CHARACTERISTICS

At $T_A = +25^\circ\text{C}$, $V_S = 5\text{V}$, $R_L = 10\text{k}\Omega$ connected to $V_S/2$, $V_{OUT} = V_S/2$, unless otherwise noted.

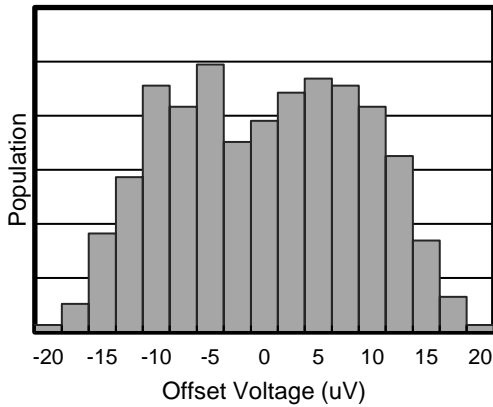

Figure 1. Offset Voltage Production Distribution

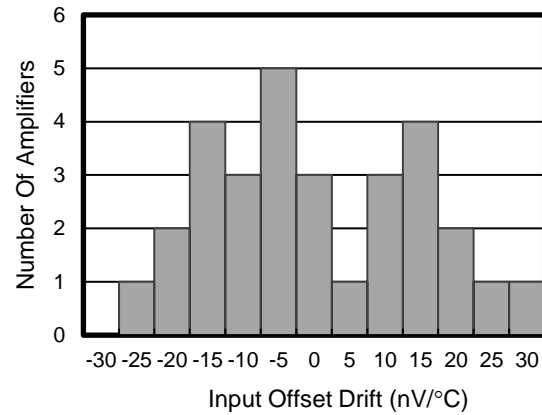

Figure 2. Offset Voltage Drift Production Distribution

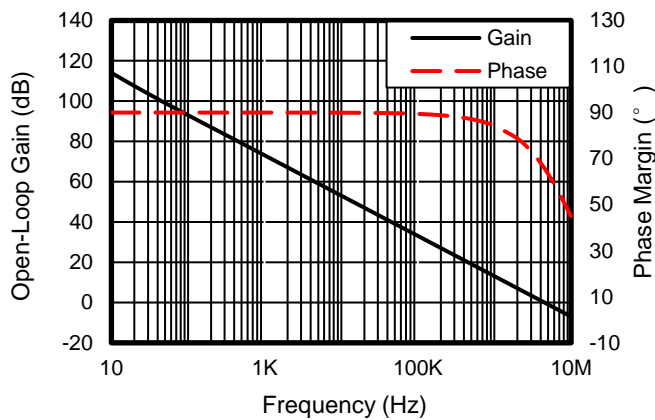

Figure 3. Open-Loop Gain and Phase vs Frequency

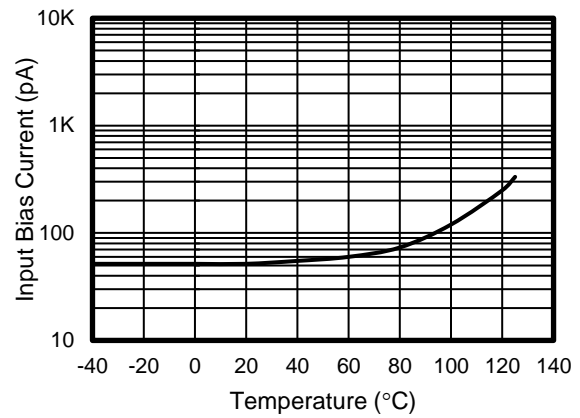

Figure 4. Input Bias Current vs Temperature

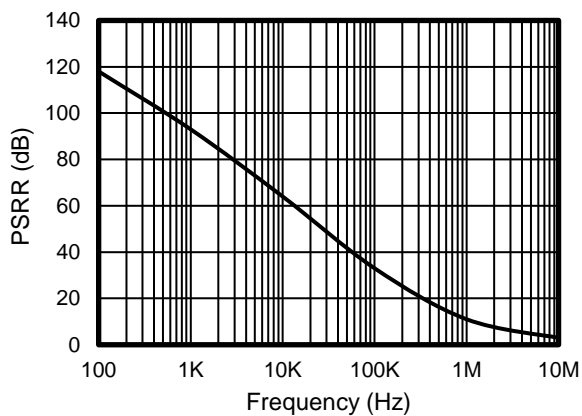

Figure 5. Power-Supply Rejection Ratio vs Frequency

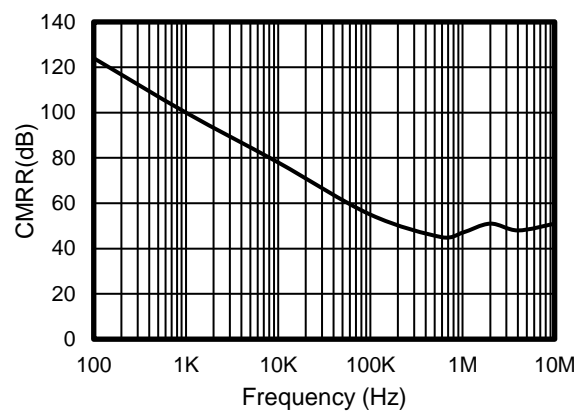

Figure 6. Common-Mode Rejection Ratio vs Frequency

TYPICAL CHARACTERISTICS

At $T_A = +25^\circ\text{C}$, $V_S = 5\text{V}$, $R_L = 10\text{k}\Omega$ connected to $V_S/2$, $V_{OUT} = V_S/2$, unless otherwise noted.

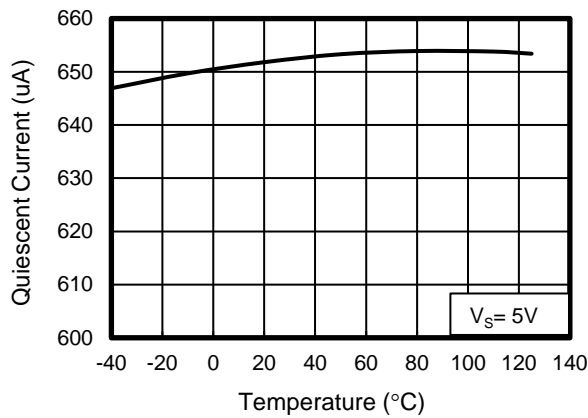

Figure 7. Quiescent Current vs Temperature

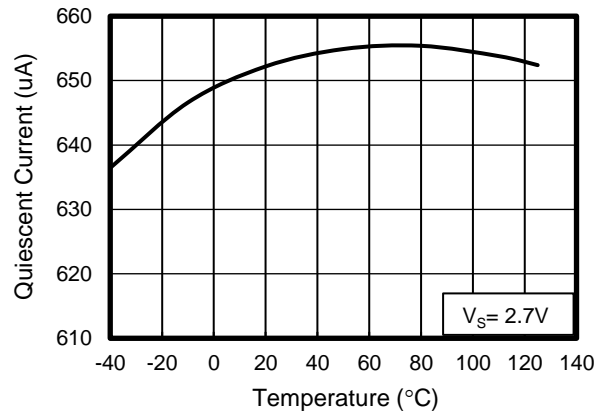

Figure 8. Quiescent Current vs Temperature

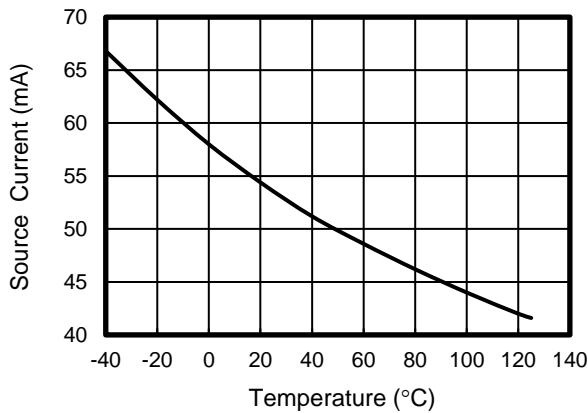

Figure 9. Source Current vs Temperature

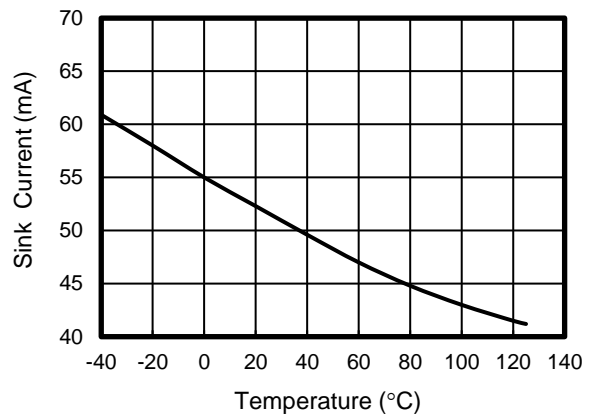

Figure 10. Sink Current vs Temperature

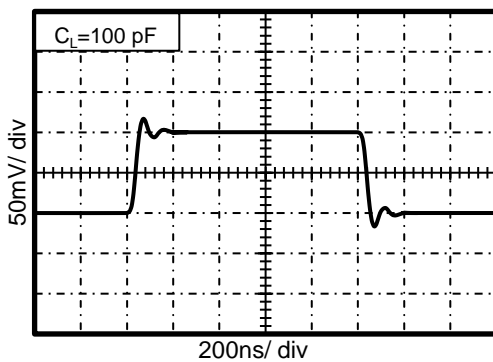

Figure 11. Small-Signal Step Response

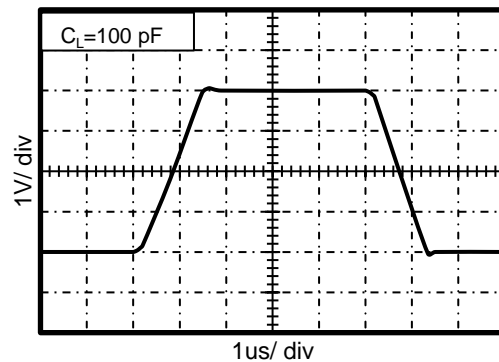

Figure 12. Large-Signal Step Response

TYPICAL CHARACTERISTICS

At $T_A = +25^\circ\text{C}$, $V_S = 5\text{V}$, $R_L = 10\text{k}\Omega$ connected to $V_S/2$, $V_{OUT} = V_S/2$, unless otherwise noted.

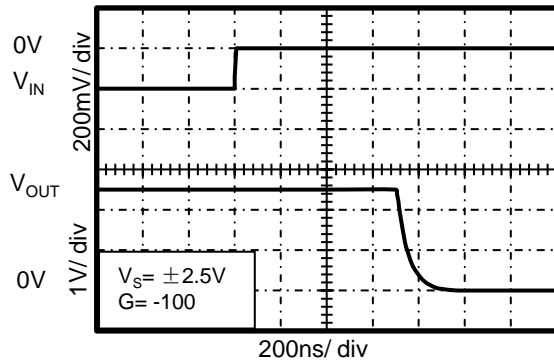

Figure 13. Positive Overvoltage Recovery

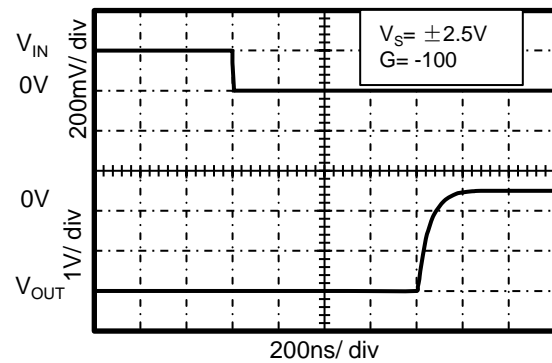

Figure 14. Negative Overvoltage Recovery

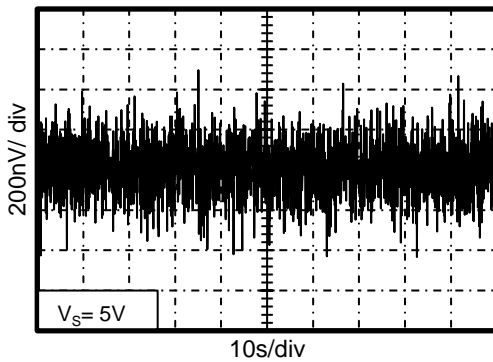

Figure 15. 0.01Hz to 10Hz Noise

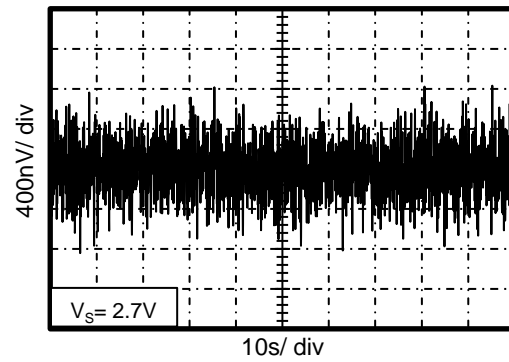

Figure 16. 0.01Hz to 10Hz Noise

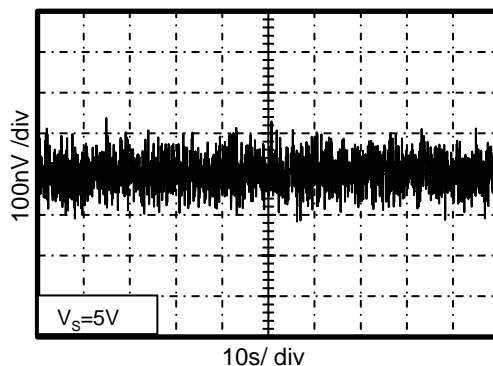

Figure 17. 0.01Hz to 1Hz Noise

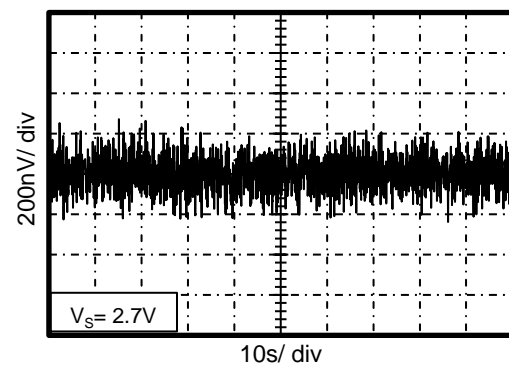

Figure 18. 0.01Hz to 1Hz Noise

Detailed Description

Overview

The RS8557, RS8558, RS8559 series op amps are unity-gain stable and free from unexpected output phase reversal. They use auto-zeroing techniques to provide low offset voltage and very low drift over time and temperature.

Good layout practice mandates use of a 0.1 μ F capacitor placed closely across the supply pins.

For lowest offset voltage and precision performance, circuit layout and mechanical conditions should be optimized. Avoid temperature gradients that create thermoelectric (Seebeck) effects in thermocouple junctions formed from connecting dissimilar conductors. These thermally-generated potentials can be made to cancel by assuring that they are equal on both input terminals.

- Use low thermoelectric-coefficient connections (avoid dissimilar metals).
- Thermally isolate components from power supplies or other heat-sources.
- Shield op amp and input circuitry from air currents, such as cooling fans.

Following these guidelines will reduce the likelihood of junctions being at different temperatures, which can cause thermoelectric voltages of 0.1 μ V/ $^{\circ}$ C or higher, depending on materials used.

OPERATING VOLTAGE

The RS8557, RS8558, RS8559 series op amps operate over a power-supply range of +2.7V to +5.5V (\pm 1.35V to \pm 2.75V). Supply voltages higher than 7V (absolute maximum) can permanently damage the amplifier. Parameters that vary over supply voltage or temperature are shown in the Typical Characteristics section of this data sheet.

APPLICATION NOTE

Typical Applications

Bidirectional Current-Sensing

This single-supply, low-side, bidirectional current-sensing solution detects load currents from -1A to 1A. The single-ended output spans from 110mV to 3.19V. This design uses the RS8557, RS8558, RS8559 because of its low offset voltage and rail-to-rail input and output. One of the amplifiers is configured as a difference amplifier and the other provides the reference voltage.

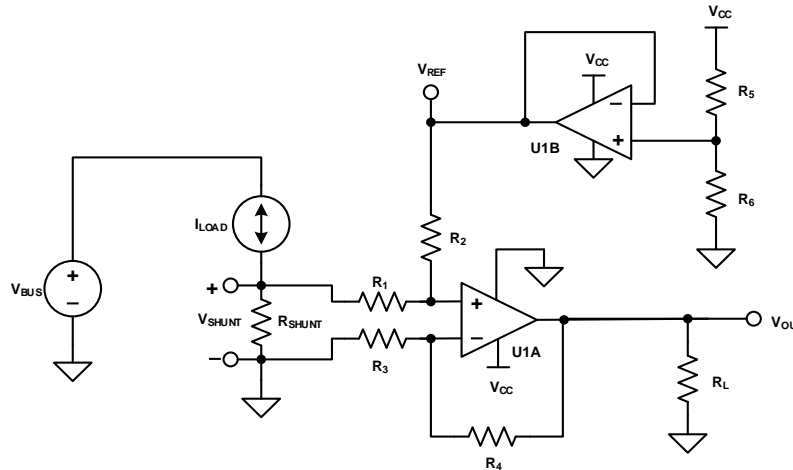

Figure 19. Bidirectional Current-Sensing Schematic

Design Requirements

This solution has the following requirements:

- Supply voltage: 3.3V
- Input: -1 A to 1 A
- Output: 1.65V \pm 1.54V (110mV to 3.19V)

Detailed Design Procedure

The load current, I_{LOAD} , flows through the shunt resistor (R_{SHUNT}) to develop the shunt voltage, V_{SHUNT} . The shunt voltage is then amplified by the difference amplifier, which consists of U1A and R_1 through R_4 . The gain of the difference amplifier is set by the ratio of R_4 to R_3 . To minimize errors, set $R_2 = R_4$ and $R_1 = R_3$. The reference voltage, V_{REF} , is supplied by buffering a resistor divider using U1B. The transfer function is given by Equation 1.

$$V_{OUT} = V_{SHUNT} \times \text{Gain}_{\text{Diff_Amp}} + V_{REF}$$

Where

$$V_{SHUNT} = I_{LOAD} \times R_{SHUNT}$$

$$\text{Gain}_{\text{Diff_Amp}} = \frac{R_4}{R_3}$$

$$V_{REF} = V_{CC} \times \left[\frac{R_6}{R_5 + R_6} \right]$$

(1)

There are two types of errors in this design: offset and gain. Gain errors are introduced by the tolerance of the shunt resistor and the ratios of R_4 to R_3 and, similarly, R_2 to R_1 . Offset errors are introduced by the voltage divider (R_5 and R_6) and how closely the ratio of R_4/R_3 matches R_2/R_1 . The latter value impacts the CMRR of the difference amplifier, which ultimately translates to an offset error. Because this is a low-side measurement, the value of V_{SHUNT} is the ground potential for the system load. Therefore, it is important to place a maximum value on V_{SHUNT} . In this design, the maximum value for V_{SHUNT} is set to 100 mV. Equation 2 calculates the maximum value of the shunt resistor given a maximum shunt voltage of 100 mV and maximum load current of 1 A.

$$R_{SHUNT(\text{Max})} = \frac{V_{SHUNT(\text{Max})}}{I_{LOAD(\text{Max})}} = \frac{100 \text{ mV}}{1 \text{ A}} = 100 \text{ m}\Omega$$

(2)

The tolerance of R_{SHUNT} is directly proportional to cost. For this design, a shunt resistor with a tolerance of 0.5%

was selected. If greater accuracy is required, select a 0.1% resistor or better.

The load current is bidirectional; therefore, the shunt voltage range is -100 mV to 100 mV . This voltage is divided down by R_1 and R_2 before reaching the operational amplifier, U1A. Take care to ensure that the voltage present at the noninverting node of U1A is within the common-mode range of the device. Therefore, it is important to use an operational amplifier, such as the RS8557, RS8558, and RS8559 that has a common-mode range that extends below the negative supply voltage. Finally, to minimize offset error, note that the RS8557, RS8558, RS8559 has a typical offset voltage of $\pm 3\mu\text{V}$ ($\pm 20\mu\text{V}$ maximum). Given a symmetric load current of -1 A to 1 A , the voltage divider resistors (R_5 and R_6) must be equal. To be consistent with the shunt resistor, a tolerance of 0.5% was selected. To minimize power consumption, $10\text{ k}\Omega$ resistors were used. To set the gain of the difference amplifier, the common-mode range and output swing of the RS8557, RS8558, and RS8559 must be considered. Equation 3 and Equation 4 depict the typical common-mode range and maximum output swing, respectively of the RS8557, RS8558, and RS8559 given a 3.3 V supply.

$$-100\text{ mV} < V_{\text{CM}} < 3.4\text{ V} \quad (3)$$

$$100\text{ mV} < V_{\text{OUT}} < 3.2\text{ V} \quad (4)$$

The gain of the difference amplifier can now be calculated as shown in Equation 5.

$$\text{Gain}_{\text{Dif_Amp}} = \frac{V_{\text{OUT_Max}} - V_{\text{OUT_Min}}}{R_{\text{SHUNT}} \times (I_{\text{MAX}} - I_{\text{MIN}})} = \frac{3.2\text{ V} - 100\text{ mV}}{100\text{ m}\Omega \times [1\text{ A} - (-1\text{ A})]} = 15.5 \frac{\text{V}}{\text{V}} \quad (5)$$

The resistor value selected for R_1 and R_3 was $1\text{ k}\Omega$. $15.4\text{ k}\Omega$ was selected for R_2 and R_4 because it is the nearest standard value. Therefore, the ideal gain of the difference amplifier is 15.4 V/V .

The gain error of the circuit primarily depends on R_1 through R_4 . As a result of this dependence, 0.1% resistors were selected. This configuration reduces the likelihood that the design requires a two-point calibration. A simple one-point calibration, if desired, removes the offset errors introduced by the 0.5% resistors.

Application Curve

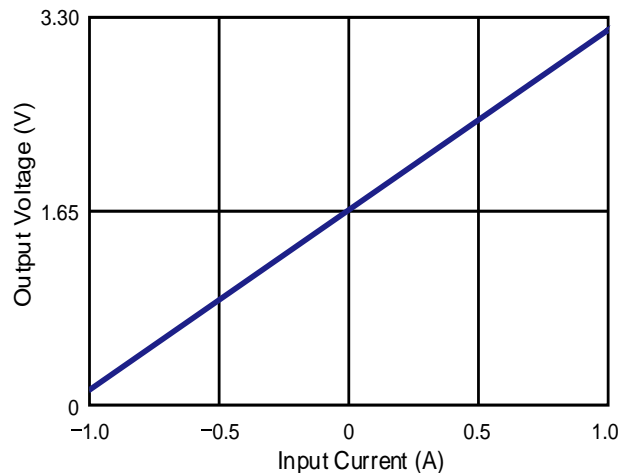

Figure 20. Bidirectional Current-Sensing Circuit Performance: Output Voltage vs Input Current

LAYOUT

Layout Guidelines

Attention to good layout practices is always recommended. Keep traces short. When possible, use a PCB ground plane with surface-mount components placed as close to the device pins as possible. Place a 0.1uF capacitor closely across the supply pins.

These guidelines should be applied throughout the analog circuit to improve performance and provide benefits such as reducing the EMI susceptibility.

Layout Example

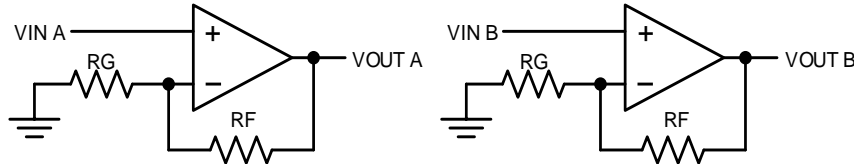

Figure 21. Schematic Representation

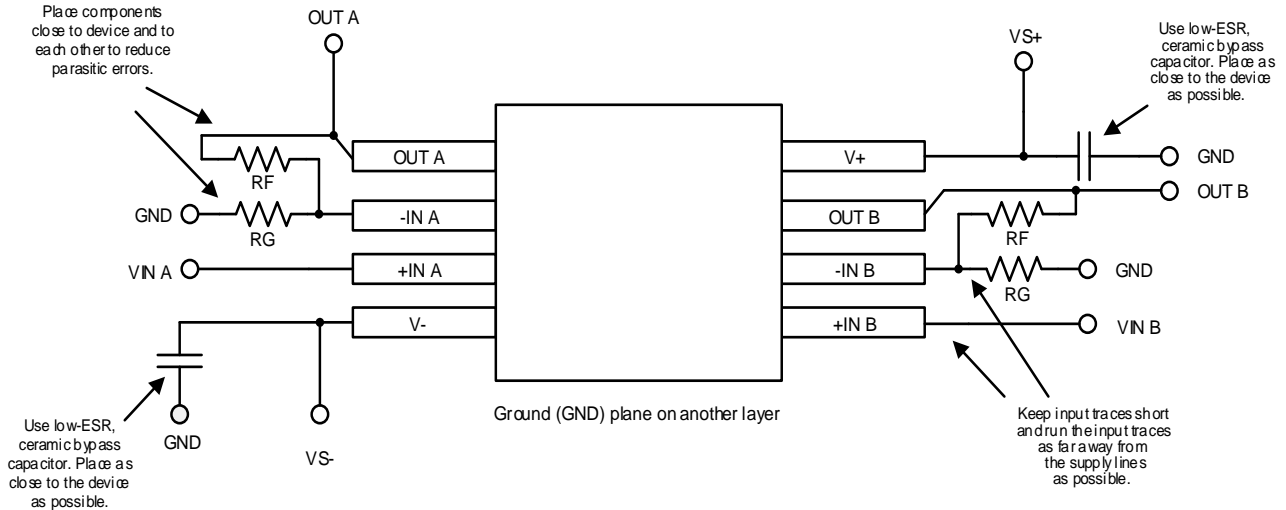
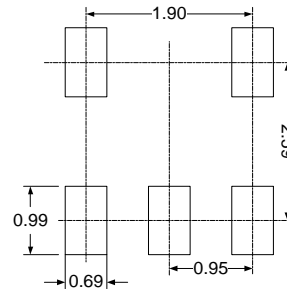
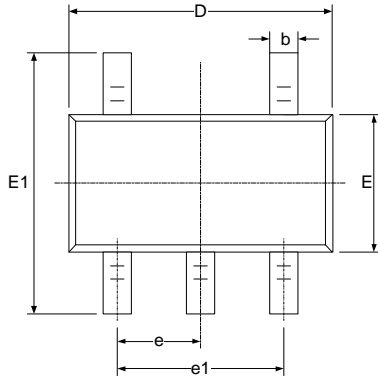

Figure 22. Layout Example

PACKAGE OUTLINE DIMENSIONS

SOT23-5



RECOMMENDED LAND PATTERN (Unit: mm)

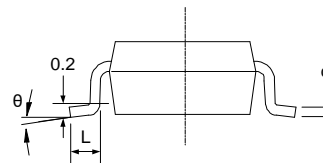
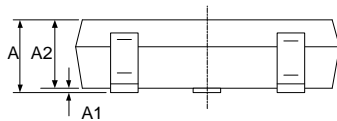

| Symbol | Dimensions In Millimeters | | Dimensions In Inches | |
|----------|---------------------------|-------|----------------------|-------|
| | Min | Max | Min | Max |
| A | 1.050 | 1.250 | 0.041 | 0.049 |
| A1 | 0.000 | 0.100 | 0.000 | 0.004 |
| A2 | 1.050 | 1.150 | 0.041 | 0.045 |
| b | 0.300 | 0.500 | 0.012 | 0.020 |
| c | 0.100 | 0.200 | 0.004 | 0.008 |
| D | 2.820 | 3.020 | 0.111 | 0.119 |
| E | 1.500 | 1.700 | 0.059 | 0.067 |
| E1 | 2.650 | 2.950 | 0.104 | 0.116 |
| e | 0.950 (BSC) | | 0.037 (BSC) | |
| e1 | 1.800 | 2.000 | 0.071 | 0.079 |
| L | 0.300 | 0.600 | 0.012 | 0.024 |
| θ | 0° | 8° | 0° | 8° |

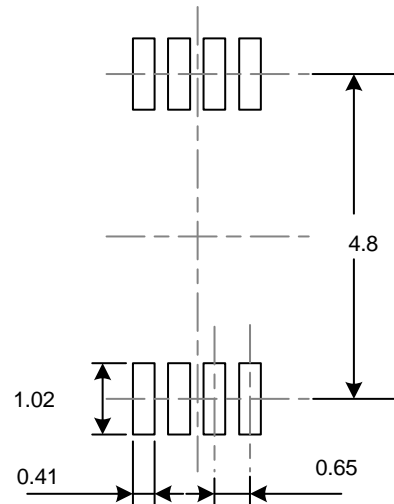
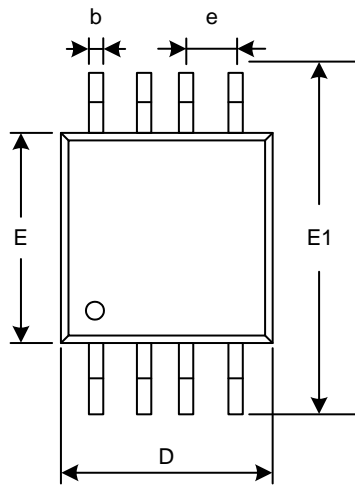
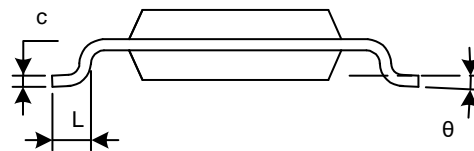
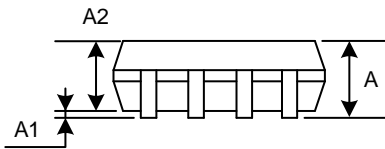
MSOP-8

RECOMMENDED LAND PATTERN (Unit: mm)

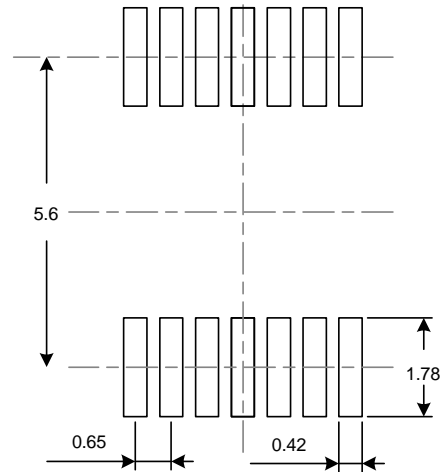
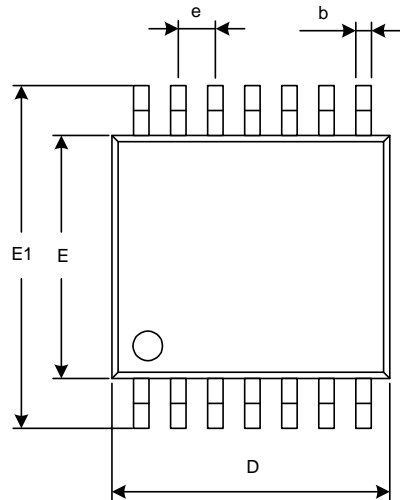
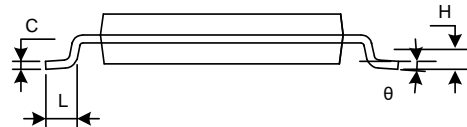
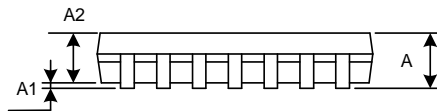
| Symbol | Dimensions In Millimeters | | Dimensions In Inches | |
|----------|---------------------------|-------|----------------------|-------|
| | Min | Max | Min | Max |
| A | 0.820 | 1.100 | 0.032 | 0.043 |
| A1 | 0.020 | 0.150 | 0.001 | 0.006 |
| A2 | 0.750 | 0.950 | 0.030 | 0.037 |
| b | 0.250 | 0.380 | 0.010 | 0.015 |
| c | 0.090 | 0.230 | 0.004 | 0.009 |
| D | 2.900 | 3.100 | 0.114 | 0.122 |
| e | 0.650 (BSC) | | 0.026 (BSC) | |
| E | 2.900 | 3.100 | 0.114 | 0.122 |
| E1 | 4.750 | 5.050 | 0.187 | 0.199 |
| L | 0.400 | 0.800 | 0.016 | 0.031 |
| θ | 0° | 6° | 0° | 6° |

TSSOP-14

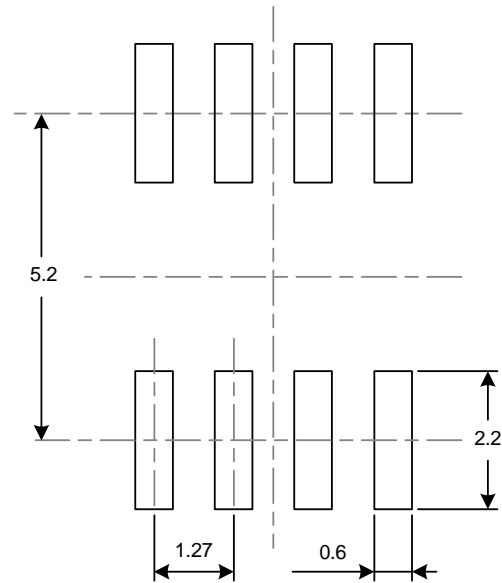
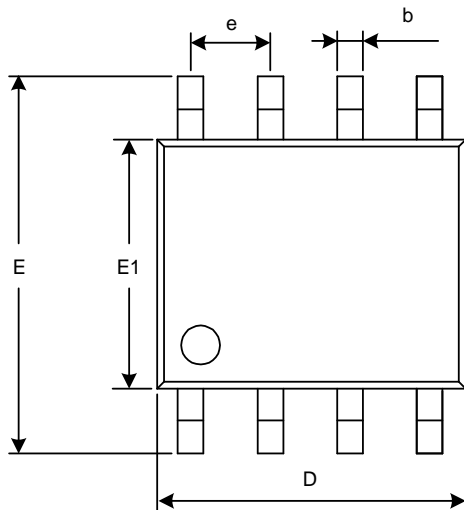
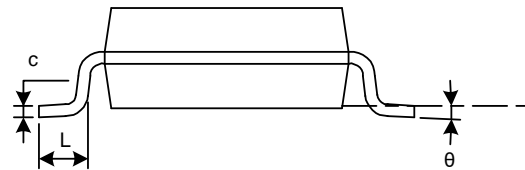
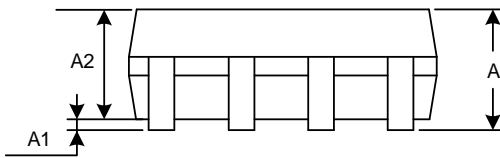
RECOMMENDED LAND PATTERN (Unit: mm)

| Symbol | Dimensions In Millimeters | | Dimensions In Inches | |
|----------|---------------------------|-------|----------------------|-------|
| | Min | Max | Min | Max |
| A | | 1.200 | | 0.047 |
| A1 | 0.050 | 0.150 | 0.002 | 0.006 |
| A2 | 0.800 | 1.050 | 0.031 | 0.041 |
| b | 0.190 | 0.300 | 0.007 | 0.012 |
| c | 0.090 | 0.200 | 0.004 | 0.008 |
| D | 4.860 | 5.100 | 0.191 | 0.201 |
| E | 4.300 | 4.500 | 0.169 | 0.177 |
| E1 | 6.250 | 6.550 | 0.246 | 0.258 |
| e | 0.650 (BSC) | | 0.026 (BSC) | |
| L | 0.500 | 0.700 | 0.020 | 0.028 |
| H | 0.25 (TYP) | | 0.01 (TYP) | |
| θ | 1° | 7° | 1° | 7° |

SOIC-8 (SOP8)

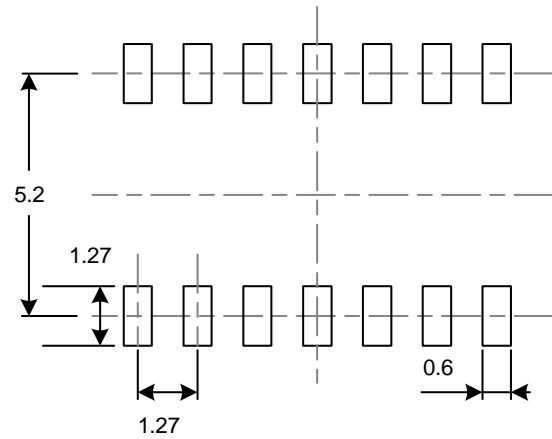
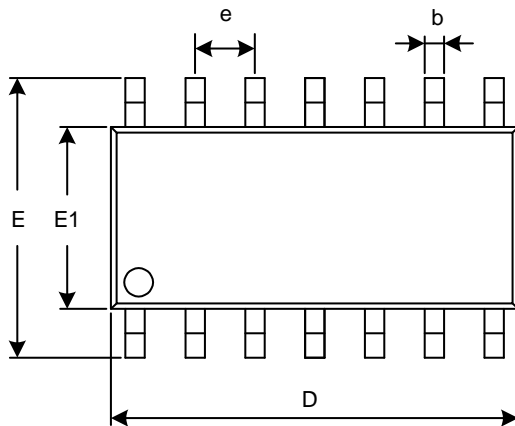
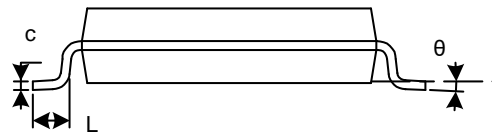
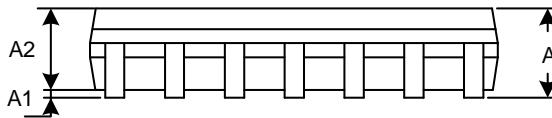
RECOMMENDED LAND PATTERN (Unit: mm)

| Symbol | Dimensions In Millimeters | | Dimensions In Inches | |
|----------|---------------------------|-------|----------------------|-------|
| | Min | Max | Min | Max |
| A | 1.350 | 1.750 | 0.053 | 0.069 |
| A1 | 0.100 | 0.250 | 0.004 | 0.010 |
| A2 | 1.350 | 1.550 | 0.053 | 0.061 |
| b | 0.330 | 0.510 | 0.013 | 0.020 |
| c | 0.170 | 0.250 | 0.007 | 0.010 |
| D | 4.800 | 5.000 | 0.189 | 0.197 |
| e | 1.270 (BSC) | | 0.050 (BSC) | |
| E | 5.800 | 6.200 | 0.228 | 0.244 |
| E1 | 3.800 | 4.000 | 0.150 | 0.157 |
| L | 0.400 | 1.270 | 0.016 | 0.050 |
| θ | 0° | 8° | 0° | 8° |

SOIC-14 (SOP14)

RECOMMENDED LAND PATTERN (Unit: mm)

| Symbol | Dimensions In Millimeters | | Dimensions In Inches | |
|----------|---------------------------|-------|----------------------|-------|
| | Min | Max | Min | Max |
| A | 1.350 | 1.750 | 0.053 | 0.069 |
| A1 | 0.100 | 0.250 | 0.004 | 0.010 |
| A2 | 1.350 | 1.550 | 0.053 | 0.061 |
| b | 0.310 | 0.510 | 0.012 | 0.020 |
| c | 0.100 | 0.250 | 0.004 | 0.010 |
| D | 8.450 | 8.850 | 0.333 | 0.348 |
| e | 1.270 (BSC) | | 0.050 (BSC) | |
| E | 5.800 | 6.200 | 0.228 | 0.244 |
| E1 | 3.800 | 4.000 | 0.150 | 0.157 |
| L | 0.400 | 1.270 | 0.016 | 0.050 |
| θ | 0° | 8° | 0° | 8° |

TAPE AND REEL INFORMATION
REEL DIMENSIONS

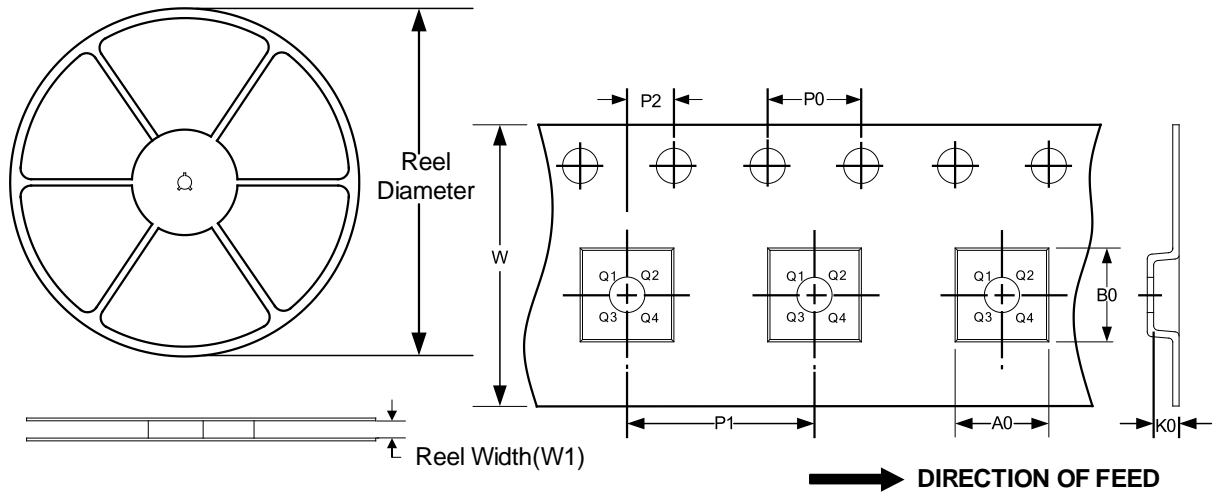
TAPE DIMENSION



NOTE: The picture is only for reference. Please make the object as the standard.

KEY PARAMETER LIST OF TAPE AND REEL

| Package Type | Reel Diameter | Reel Width (mm) | A0 (mm) | B0 (mm) | K0 (mm) | P0 (mm) | P1 (mm) | P2 (mm) | W (mm) | Pin1 Quadrant |
|-----------------|---------------|-----------------|---------|---------|---------|---------|---------|---------|--------|---------------|
| SOT23-5 | 7" | 9.5 | 3.20 | 3.20 | 1.40 | 4.0 | 4.0 | 2.0 | 8.0 | Q3 |
| MSOP8 | 13" | 12.4 | 5.20 | 3.30 | 1.50 | 4.0 | 8.0 | 2.0 | 12.0 | Q1 |
| TSSOP14 | 13" | 12.4 | 6.95 | 5.60 | 1.20 | 4.0 | 8.0 | 2.0 | 12.0 | Q1 |
| SOIC-8 (SOP8) | 13" | 12.4 | 6.40 | 5.40 | 2.10 | 4.0 | 8.0 | 2.0 | 12.0 | Q1 |
| SOIC-14 (SOP14) | 13" | 16.4 | 6.60 | 9.30 | 2.10 | 4.0 | 8.0 | 2.0 | 16.0 | Q1 |

X-ON Electronics

Largest Supplier of Electrical and Electronic Components

Click to view similar products for [Precision Amplifiers](#) category:

Click to view products by [RUNIC](#) manufacturer:

Other Similar products are found below :

[LM201AN](#) [MCP6V52-E/MS](#) [ADA4692-4ARUZ-RL](#) [EL8176FSZ](#) [ISL28158FHZ-T7](#) [ISL28236FBZ](#) [ISL28236FBZ-T7](#) [ISL28258FUZ](#)
[ISL28258FUZ-T7](#) [ISL28276FBZ](#) [ISL28276IAZ](#) [ISL28276IAZ-T7](#) [ISL28288FUZ](#) [NCS21914DR2G](#) [NCS21914DTBR2G](#) [RS8654XP](#)
[AD8615AUJZ-REEL](#) [HG2376M/TR](#) [MS8362M](#) [LT1013IS8#TRPBF](#) [ADA4610-4ARZ-R7](#) [TP5591-TR](#) [AD8652ARZ-REEL](#) [AD8639ARZ-](#)
[REEL](#) [ADA4622-2ARZ-RL](#) [LTC6241HVCS8#TRPBF](#) [LT6011IS8#TRPBF](#) [LT6230IS6-10#TRPBF](#) [LT6011IMS8#TRPBF](#)
[LTC6246CS6#TRMPBF](#) [LT6230CS6#TRPBF](#) [ADA4610-2BRZ-RL](#) [LTC2054HS5#TRPBF](#) [LT6235IGN#TRPBF](#) [LTC6362IDD#TRPBF](#)
[AD8625ARUZ-REEL](#) [LTC2050HVIS8#TRPBF](#) [AD8627AKSZ-REEL](#) [LT6220IS5#TRPBF](#) [LT6236IS6#TRPBF](#) [OP213ESZ-REEL](#)
[ADA4092-4ARUZ-RL](#) [CBM8532AMS8](#) [CBM8628AST5](#) [CBM8534AS14](#) [CBM8608AS14](#) [CBM8534ATS14](#) [CBM8605AST5](#)
[CBM8629AS8](#) [CBM8608ATS14](#)