

250MHz, Rail-to-Rail Output CMOS Operational Amplifier

FEATURES

- **HIGH GAIN BANDWIDTH: 250MHz**
- **RAIL-TO-RAIL OUTPUT**
- **1.5mV Typical Vos**
- **INPUT VOLTAGE RANGE: -0.2V to +3.9V**
with $V_s = 5V$
- **SUPPLY RANGE: +2.5V to +5.5V**
- **SPECIFIED UP TO +125°C**
- **Micro SIZE PACKAGES: SOT23-5**

APPLICATIONS

- **AUDIO ADC INPUT BUFFERS**
- **PHOTODIODE PREAMP**
- **HIGH-DENSITY SYSTEMS**
- **PORTABLE SYSTEMS**
- **DRIVING A/D CONVERTERS**

DESCRIPTION

The RS875X families of voltage-feedback (VFB) products offer low voltage operation, negative-rail input, rail-to-rail output, as well as excellent speed/power consumption ratio, providing an excellent bandwidth (250MHz) and slew rate of 180V/us. The op-amps are unity gain stable and feature an ultra-low input bias current.

These amplifiers set an industry-leading power-to-performance ratio for rail-to-rail amplifiers. The RS875X families of operational amplifiers are specified at the full temperature range of $-40^{\circ}C$ to $+125^{\circ}C$ under single or dual power supplies of 2.5V to 5.5V.

PIN CONFIGURATIONS

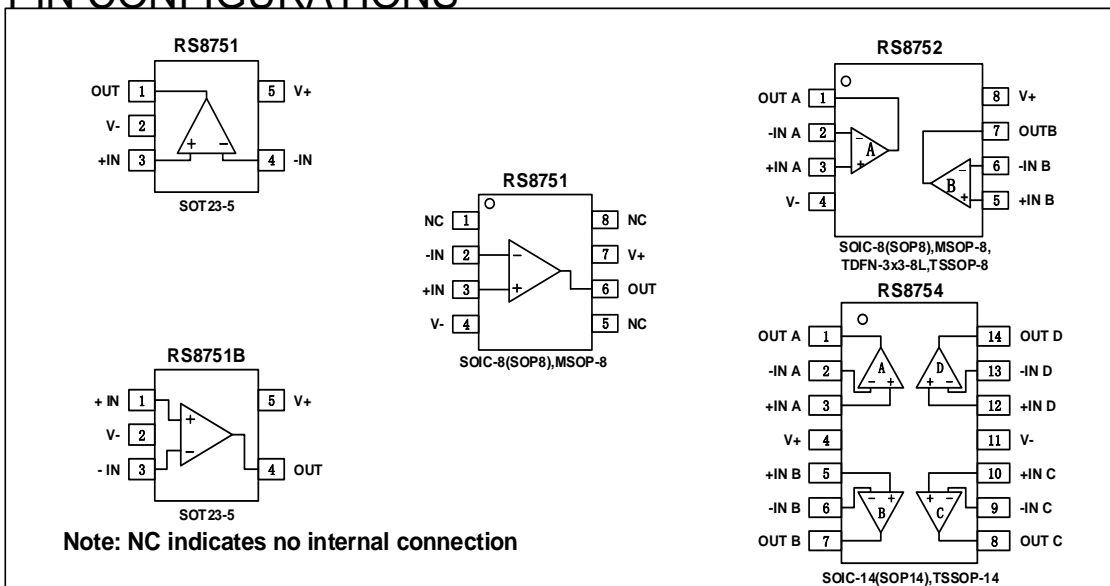

ABSOLUTE MAXIMUM RATINGS ⁽¹⁾

Supply Voltage, V+ to V-.....	7.0V
Input Terminals, Voltage ⁽²⁾	- 0.5 to (V+) + 0.5V
Current ⁽²⁾	±10mA
Storage Temperature	-65°C to +150°C
Operating Temperature	-40°C to +125°C
Junction Temperature.....	150°C
Package Thermal Resistance @ T _A = +25°C	
SOT23-5, SOT23-6.....	200°C/W
MSOP-10, SOIC-8 ,TSSOP-8.....	150°C/W
SOIC-14, TSSOP-14.....	100°C/W
Lead Temperature (Soldering, 10s)	260°C
ESD Susceptibility	
HBM	5000V
MM	400V

ESD SENSITIVITY CAUTION

ESD damage can range from subtle performance degradation to complete device failure. Precision integrated circuits may be more susceptible to damage because very small parametric changes could cause the device not to meet its published specifications.

(1) Stresses above these ratings may cause permanent damage. Exposure to absolute maximum conditions for extended periods may degrade device reliability. These are stress ratings only, and functional operation of the device at these or any other conditions beyond those specified is not implied.

(2) Input terminals are diode-clamped to the power-supply rails. Input signals that can swing more than 0.5V beyond the supply rails should be current-limited to 10mA or less.

PACKAGE/ORDERING INFORMATION

PRODUCT	ORDERING NUMBER	TEMPERATURE RANGE	PACKAGE LEAD	PACKAGE MARKING	PACKAGE OPTION
RS8751	RS8751XK	-40°C~125°C	SOIC-8(SOP8)	RS8751	Tape and Reel,2500
	RS8751XF	-40°C~125°C	SOT23-5	8751	Tape and Reel,3000
	RS8751BXF	-40°C~125°C	SOT23-5	8751B	Tape and Reel,3000
	RS8751XM	-40°C~125°C	MSOP-8	RS8751	Tape and Reel,3000
RS8752	RS8752XK	-40°C~125°C	SOIC-8(SOP8)	RS8752	Tape and Reel,2500
	RS8752XM	-40°C~125°C	MSOP-8	RS8752	Tape and Reel,3000
	RS8752XTDC8	-40°C~125°C	TDFN-3x3-8L	RS8752	Tape and Reel,3000
	RS8752XQ	-40°C~125°C	TSSOP-8	RS8752	Tape and Reel,3000
RS8754	RS8754XP	-40°C~125°C	SOIC-14(SOP14)	RS8754	Tape and Reel,2500
	RS8754XQ	-40°C~125°C	TSSOP-14	RS8754	Tape and Reel,3000

ELECTRICAL CHARACTERISTICS

(At TA = +25°C, VS = 5V, G = +2, RF = 1K Ω, and RL = 1KΩ connected to VS/2, VIN_CM =VS/2, unless otherwise noted.)

PARAMETER		CONDITIONS	RS8751,RS8752,RS8754			UNITS
			MIN	TYP	MAX	
POWER SUPPLY						
Vs	Operating Voltage Range		2.5		5.5	V
IQ	Quiescent Current/Amplifier			2.9	3.5	mA
PSRR	Power-Supply Rejection Ratio	Vs=2.5V to 5.5V, Vcm=(V-)+0.5V	70	90		dB
INPUT						
Vos	Input Offset Voltage	Vcm=Vs/2		±1.5	±7.5	mV
ΔVos/ΔT	Input Offset Voltage Drift	Vcm=Vs/2, -40°C ≤ TA ≤125°C		4		μV/°C
IB	Input Bias Current			1	10	pA
Ios	Input Offset Current			1	10	pA
Vcm	Common-Mode Voltage Range	Vs= 5V	-0.2		3.9	V
CMRR	Common-Mode Rejection Ratio	Vs= 5.5V, Vcm=-0.2V to 3.5V	66	85		dB
OUTPUT						
AOL	Open-Loop Voltage Gain	Vs=5.0V, RL=1KΩ, Vo=Vs-0.2V	95	110		dB
		Vs=5.0V, RL=150Ω, Vo=Vs-0.3V	78	85		dB
	Output Swing From Rail	RL=1KΩ		23		mV
Iout	Output Current Source			85		mA
Iout	Output Current Sink			125		mA
FREQUENCY RESPONSE						
	Small-Signal Bandwidth	VOUT=100mVpp,G=1		250		MHz
		VOUT=100mVpp,G=2		130		MHz
		VOUT=100mVpp,G=5		33		MHz
		VOUT=100mVpp,G=10		15		MHz
SR	Slew Rate			180		V/us
GBP	Gain-Bandwidth Product			250		MHz
PM	Phase Margin			62		°
NOISE						
enp-p	Input Voltage Noise	f = 0.1 Hz to 10 Hz		13		μVpp
en	Input Voltage Noise Density	f = 1 MHz		8		nV/√Hz

TYPICAL CHARACTERISTICS

At TA = +25°C, VS = 5V, G = +2, RF = 1K Ω, and RL = 1KΩ connected to VS/2, VIN_CM = VS/2, unless otherwise noted

Non-Inverting Small-Signal Frequency Response

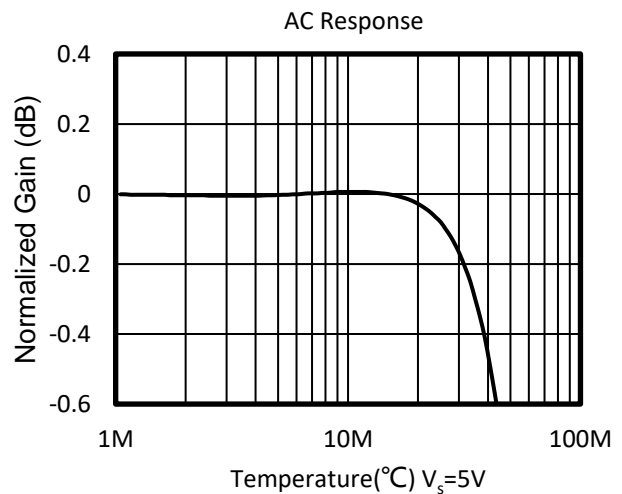
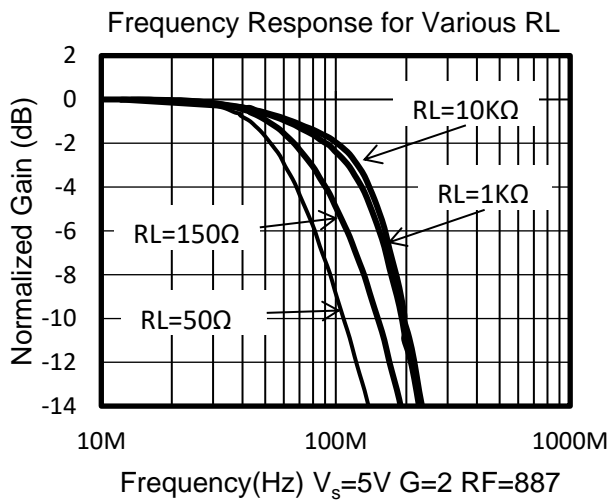
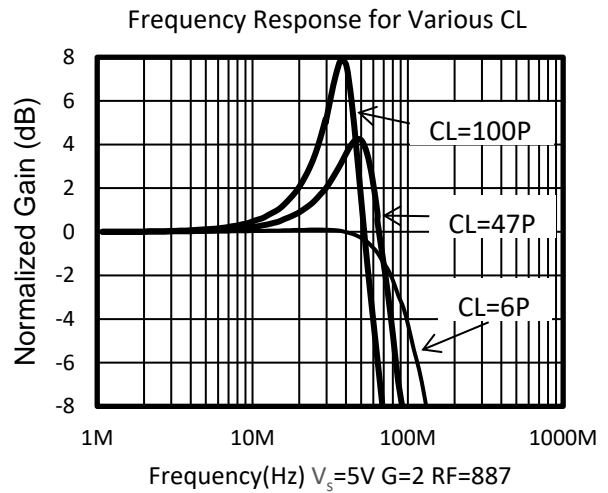
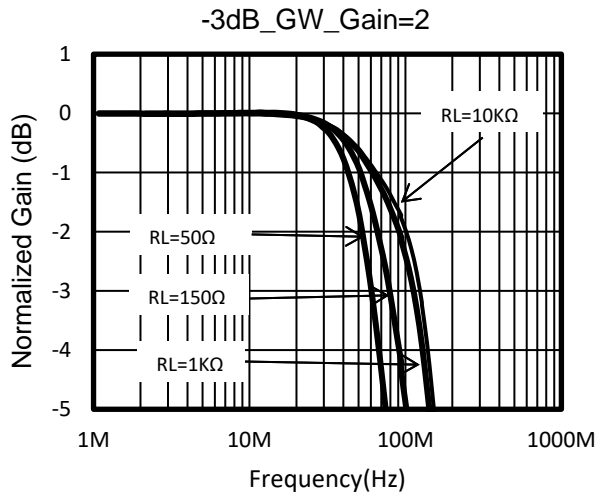
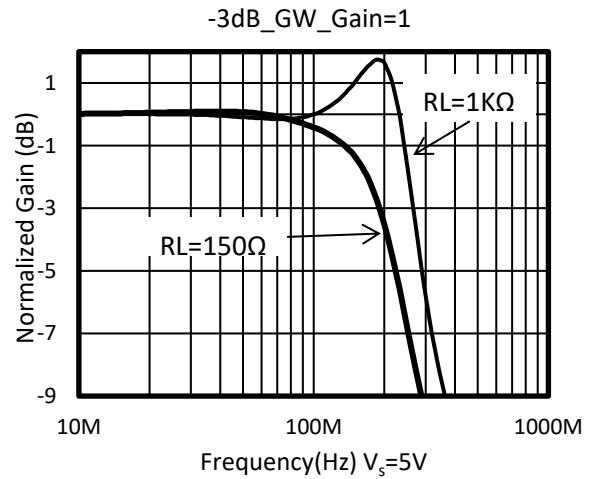
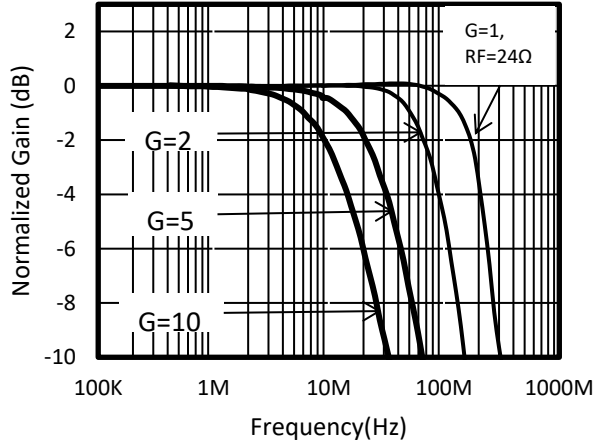

TYPICAL CHARACTERISTICS

At TA = +25°C, VS = 5V, G = +2, RF = 1K Ω, and RL = 1KΩ connected to VS/2, VIN_CM = VS/2, unless otherwise noted

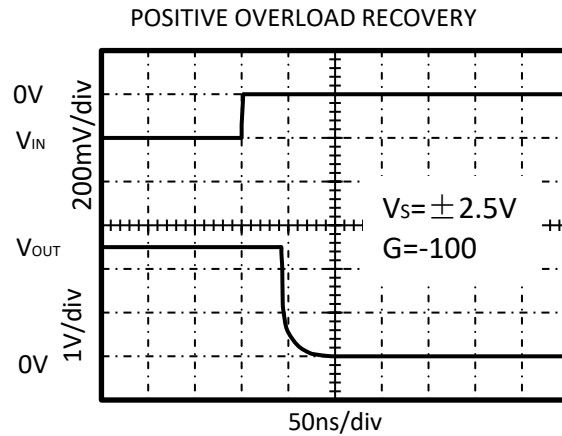
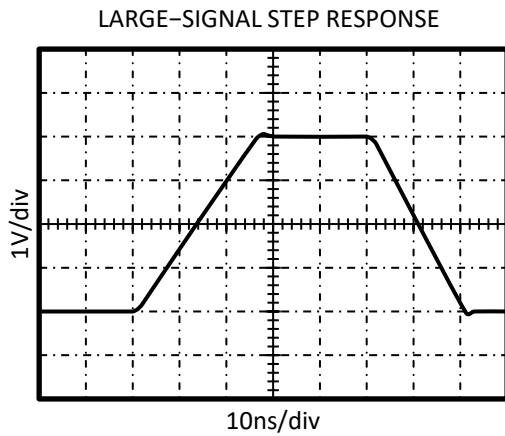
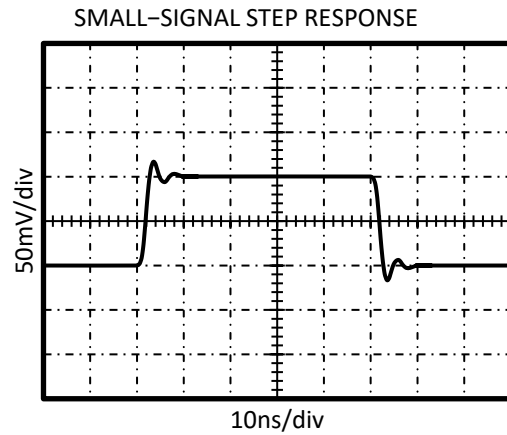
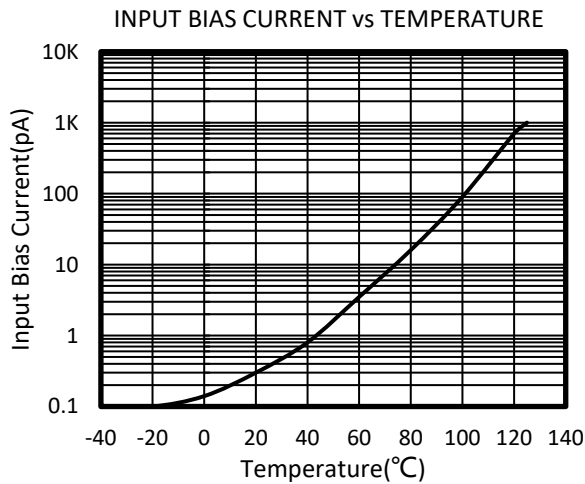
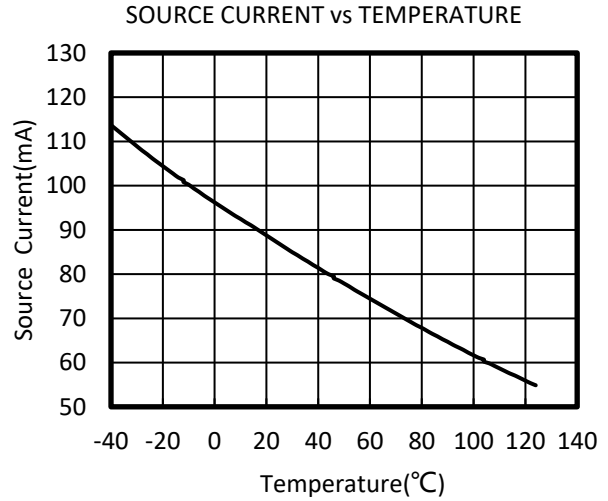
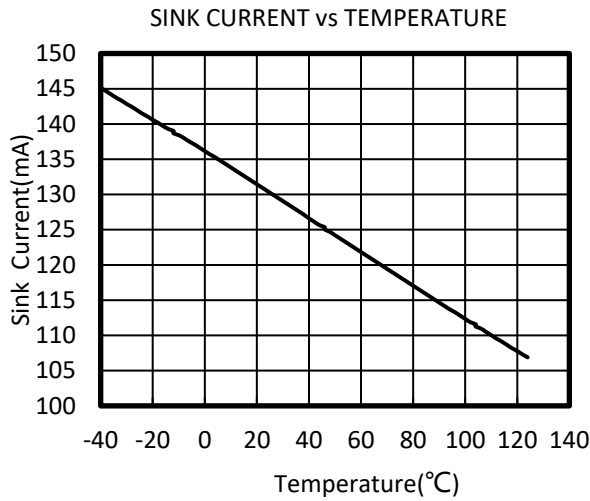

TYPICAL CHARACTERISTICS

At TA = +25°C, VS = 5V, G = +2, RF = 1KΩ, and RL = 1KΩ connected to VS/2, VIN_CM = VS/2, unless otherwise noted

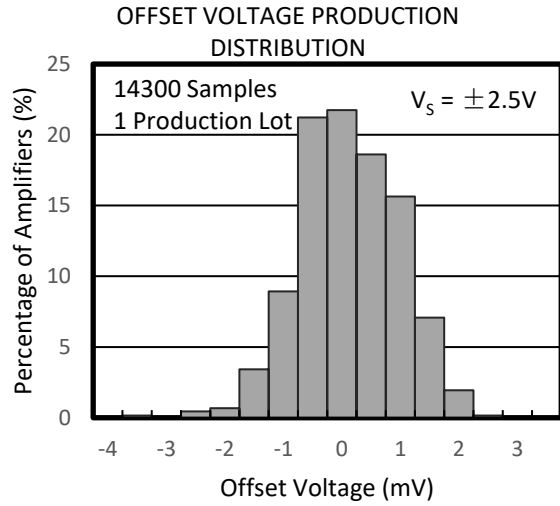
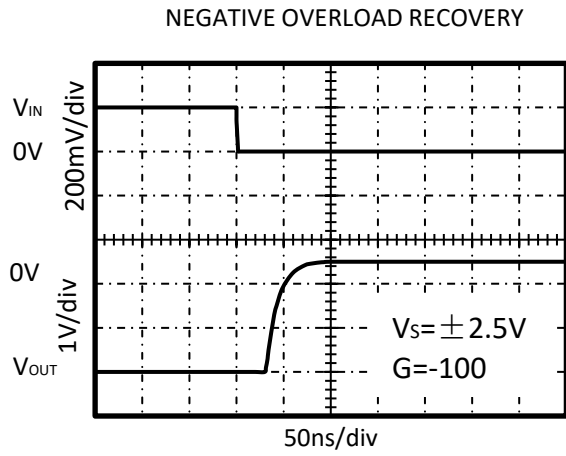

APPLICATION NOTES

The RS8751, RS8752, RS8754 are high precision, rail-to-rail operational amplifiers that can be run from a single-supply voltage 2.5V to 5.5V ($\pm 1.25V$ to $\pm 2.75V$). Supply voltages higher than 7V (absolute maximum) can permanently damage the amplifier.

Rail-to-rail input and output swing significantly increases dynamic range, especially in low-supply applications.

Good layout practice mandates use of a 0.1uF capacitor place closely across the supply pins.

LAYOUT GUIDELINS

Attention to good layout practices is always recommended. Keep traces short. When possible, use a PCB ground plane with surface-mount components placed as close to the device pins as possible. Place a 0.1uF capacitor closely across the supply pins.

These guidelines should be applied throughout the analog circuit to improve performance and provide benefits such as reducing the EMI susceptibility.

INSTRUMENTATION AMPLIFIER

In the three-op amp, instrumentation amplifier configuration shown in Figure2,

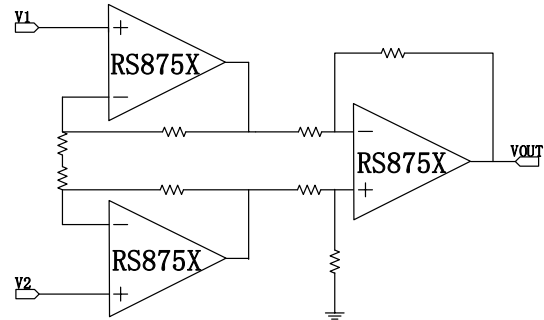

Figure2. Amplifier instrumentation amplifier

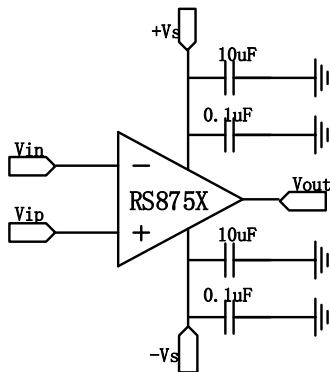
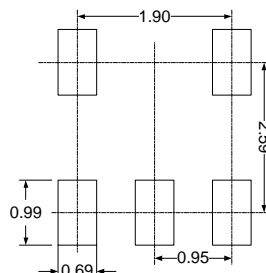
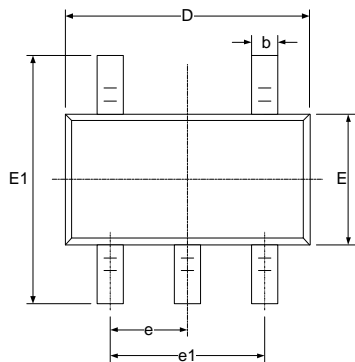

Figure1. Amplifier with Bypass Capacitors

PACKAGE OUTLINE DIMENSIONS

SOT23-5



RECOMMENDED LAND PATTERN (Unit: mm)

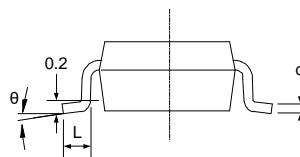
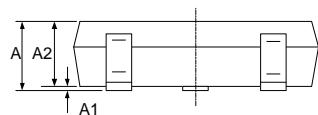

Symbol	Dimensions In Millimeters		Dimensions In Inches	
	Min	Max	Min	Max
A	1.050	1.250	0.041	0.049
A1	0.000	0.100	0.000	0.004
A2	1.050	1.150	0.041	0.045
b	0.300	0.500	0.012	0.020
c	0.100	0.200	0.004	0.008
D	2.820	3.020	0.111	0.119
E	1.500	1.700	0.059	0.067
E1	2.650	2.950	0.104	0.116
e	0.950(BSC)		0.037(BSC)	
e1	1.800	2.000	0.071	0.079
L	0.300	0.600	0.012	0.024
θ	0°	8°	0°	8°

MSOP-8

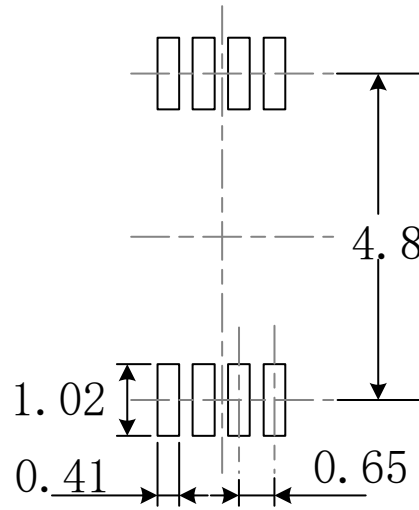
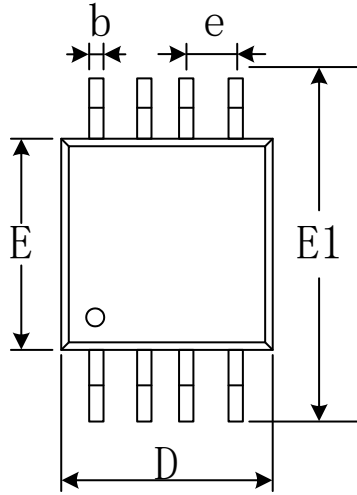

RECOMMENDED LAND PATTERN (Unit: mm)

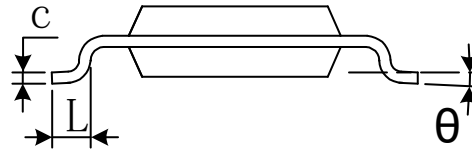
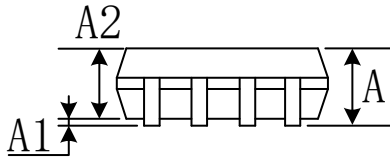

Symbol	Dimensions In Millimeters		Dimensions In Inches	
	Min	Max	Min	Max
A	0.820	1.100	0.032	0.043
A1	0.020	0.150	0.001	0.006
A2	0.750	0.950	0.030	0.037
b	0.250	0.380	0.010	0.015
c	0.090	0.230	0.004	0.009
D	2.900	3.100	0.114	0.122
e	0.650(BSC)		0.026(BSC)	
E	2.900	3.100	0.114	0.122
E1	4.750	5.050	0.187	0.199
L	0.400	0.800	0.016	0.031
θ	0°	6°	0°	6°

TSSOP-8

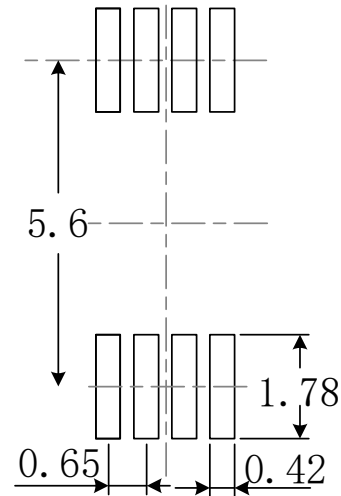
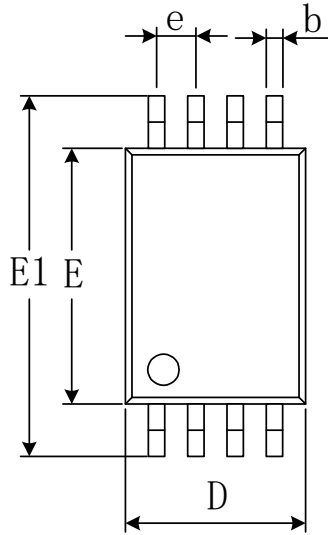

RECOMMENDED LAND PATTERN (Unit: mm)

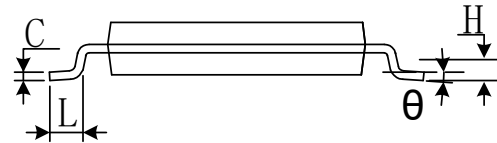
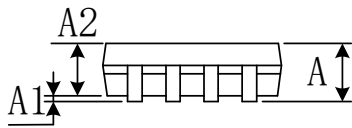

Symbol	Dimensions In Millimeters		Dimensions In Inches	
	Min	Max	Min	Max
A		1.200		0.047
A1	0.050	0.150	0.002	0.006
A2	0.800	1.050	0.031	0.041
b	0.190	0.300	0.007	0.012
c	0.090	0.200	0.004	0.008
D	2.900	3.100	0.114	0.122
E	4.300	4.500	0.169	0.177
E1	6.250	6.550	0.246	0.258
e	0.650(BSC)		0.026(BSC)	
L	0.500	0.700	0.020	0.028
H	0.25(TYP)		0.01(TYP)	
θ	1°	7°	1°	7°

TSSOP-14

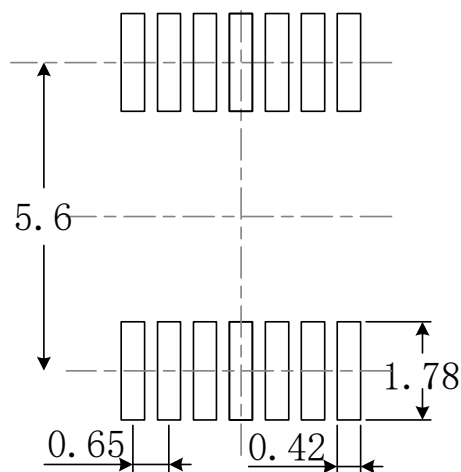
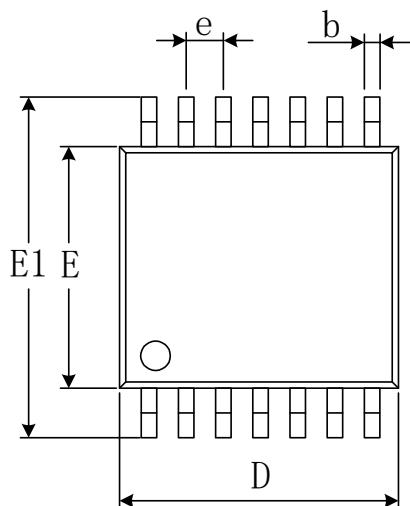
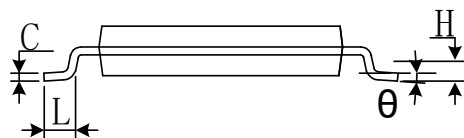
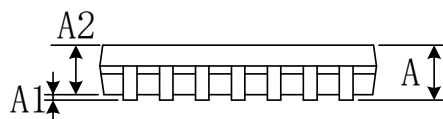

RECOMMENDED LAND PATTERN (Unit: mm)

Symbol	Dimensions In Millimeters		Dimensions In Inches	
	Min	Max	Min	Max
A		1.200		0.047
A1	0.050	0.150	0.002	0.006
A2	0.800	1.050	0.031	0.041
b	0.190	0.300	0.007	0.012
c	0.090	0.200	0.004	0.008
D	4.860	5.100	0.191	0.201
E	4.300	4.500	0.169	0.177
E1	6.250	6.550	0.246	0.258
e	0.650(BSC)		0.026(BSC)	
L	0.500	0.700	0.020	0.028
H	0.25(TYP)		0.01(TYP)	
θ	1°	7°	1°	7°

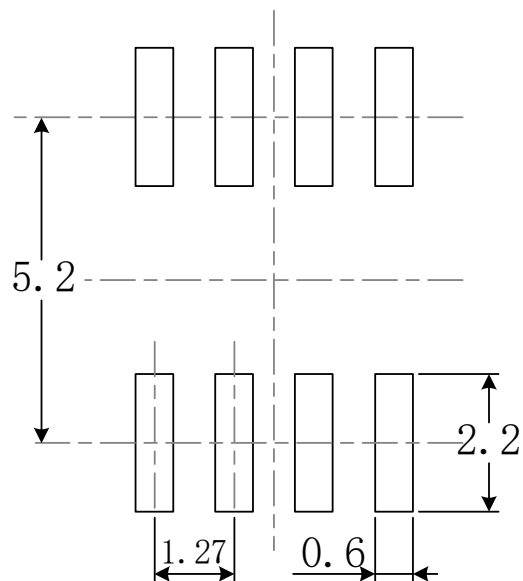
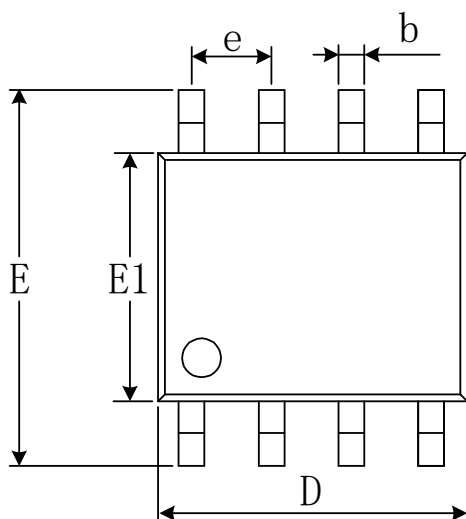
SOIC-8(SOP8)

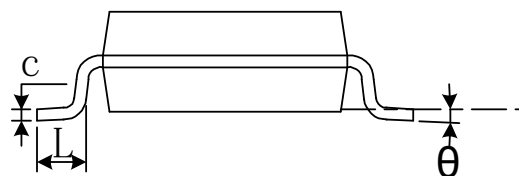
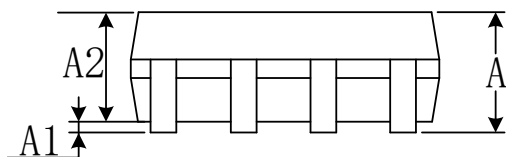

RECOMMENDED LAND PATTERN (Unit: mm)



Symbol	Dimensions In Millimeters		Dimensions In Inches	
	Min	Max	Min	Max
A	1.350	1.750	0.053	0.069
A1	0.100	0.250	0.004	0.010
A2	1.350	1.550	0.053	0.061
b	0.330	0.510	0.013	0.020
c	0.170	0.250	0.007	0.010
D	4.800	5.000	0.189	0.197
e	1.270(BSC)		0.050(BSC)	
E	5.800	6.200	0.228	0.244
E1	3.800	4.000	0.150	0.157
L	0.400	1.270	0.016	0.050
θ	0°	8°	0°	8°

SOIC-14(SOP14)

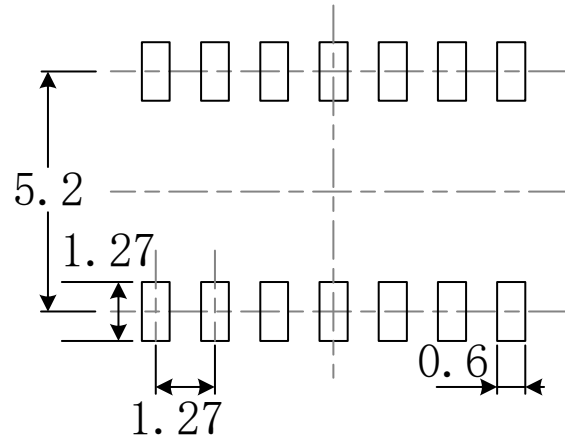
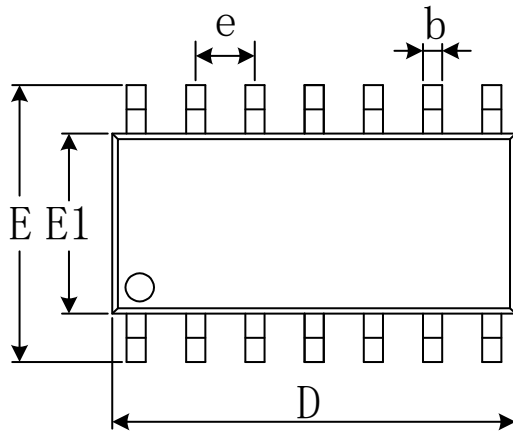

RECOMMENDED LAND PATTERN (Unit: mm)

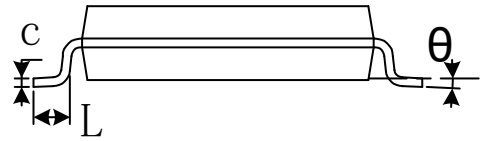
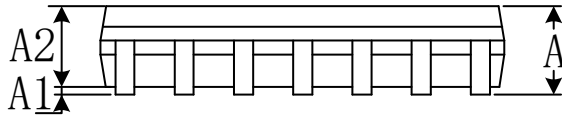

Symbol	Dimensions In Millimeters		Dimensions In Inches	
	Min	Max	Min	Max
A	1.350	1.750	0.053	0.069
A1	0.100	0.250	0.004	0.010
A2	1.350	1.550	0.053	0.061
b	0.310	0.510	0.012	0.020
c	0.100	0.250	0.004	0.010
D	8.450	8.850	0.333	0.348
e	1.270(BSC)		0.050(BSC)	
E	5.800	6.200	0.228	0.244
E1	3.800	4.000	0.150	0.157
L	0.400	1.270	0.016	0.050
θ	0°	8°	0°	8°

TDFN-3x3-8L

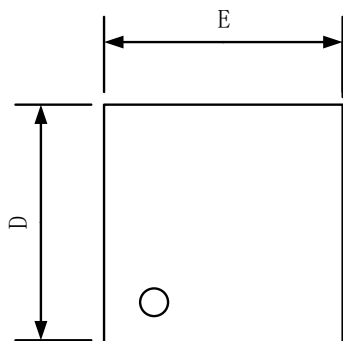

TOP VIEW

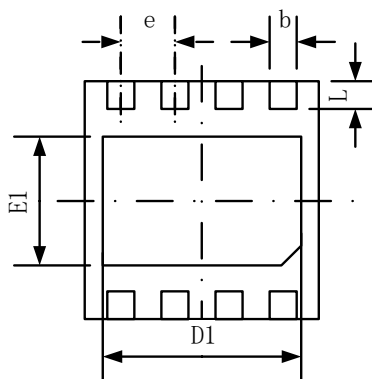

BOTTOM VIEW

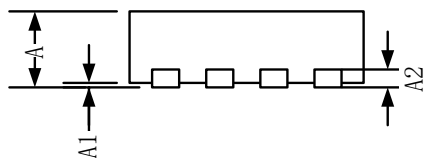

SIDE VIEW

Symbol	Dimensions In Millimeters		Dimensions In Inches	
	Min	Max	Min	Max
A	0.700	0.800	0.028	0.031
A1	0.000	0.050	0.000	0.002
A2	0.203		0.008	
b	0.300	0.400	0.012	0.016
D	2.900	3.100	0.114	0.122
D1	2.510	2.610	0.099	0.103
E	2.900	3.100	0.114	0.122
E1	1.550	1.650	0.061	0.065
e	0.650 TYP		0.026 TYP	
L	0.350	0.450	0.014	0.018

X-ON Electronics

Largest Supplier of Electrical and Electronic Components

Click to view similar products for [High Speed Operational Amplifiers](#) category:

Click to view products by [RUNIC](#) manufacturer:

Other Similar products are found below :

[NJU7047RB1-TE2](#) [LT6301IFE](#) [ADA4895-2ARMZ-R7](#) [MAX4381EUB+](#) [OPA2677IDDAR](#) [LTC6401CUD-26#PBF](#) [THS6042ID](#)
[THS4221DBVR](#) [THS4081CD](#) [LTC6400IUD-20#PBF](#) [THS4051CDR](#) [LT1223CN8#PBF](#) [OPA2889IDGSR](#) [LT6202IS5#TRMPBF](#)
[EL8302IUZ-T7](#) [LT6201CS8#PBF](#) [LT1206CR#PBF](#) [LT1260CN#PBF](#) [LT6203IDD#PBF](#) [LT1810IMS8#PBF](#) [TPH2502-SR](#) [OPA2132PAG4](#)
[OPA2353UA/2K5](#) [OPA2691I-14D](#) [OPA4353UA/2K5](#) [OPA690IDRG4](#) [AD8000YCPZ-REEL7](#) [AD8007AKSZ-REEL7](#) [AD8010ANZ](#)
[AD8012ARMZ-REEL7](#) [AD8014ARTZ-REEL7](#) [AD8016AREZ](#) [AD8021ARMZ-REEL7](#) [AD8024ARZ](#) [AD8028ARMZ](#) [AD8030ARJZ-](#)
[REEL7](#) [AD8036ANZ](#) [AD8038AKSZ-REEL7](#) [AD8039ARTZ-REEL7](#) [AD8040WARUZ-REEL7](#) [AD8041ANZ](#) [AD8044ANZ](#) [AD8051ARTZ-](#)
[REEL7](#) [AD8055ANZ](#) [AD8056ANZ](#) [AD8056ARMZ](#) [AD8057ARTZ-REEL7](#) [AD8058ARMZ](#) [AD8058ARMZ-REEL7](#) [AD8061ARTZ-REEL7](#)