

# Enclosed Plastic Body Limit Switches



## Bi2 Series



### W

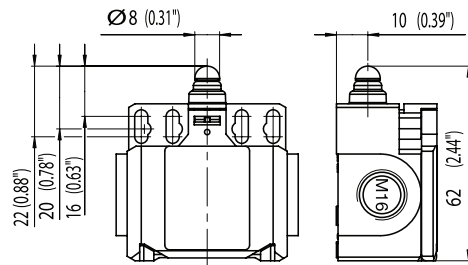

### RIW

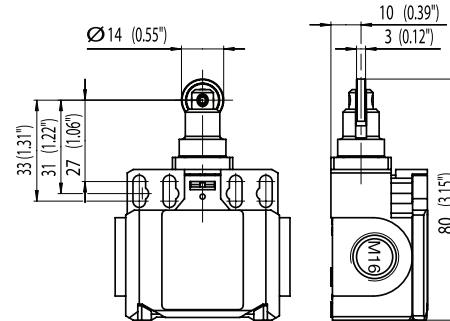

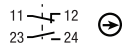
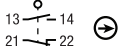
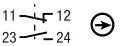
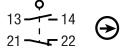
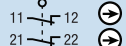
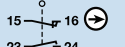
Switching Operation	Slow Action	Snap Action	Slow Action	Snap Action
<b>1 NC / 1 NO Contacts</b>	<b>608.5103.100</b> BI2-U1Z W 	<b>608.5153.107</b> BI2-SU1Z W 	<b>608.5117.101</b> BI2-U1Z RIW 	<b>608.5167.108</b> BI2-SU1Z RIW 
<b>2 NC Contacts</b>	<b>608.5803.116</b> BI2-A2Z W 	-	-	-
<b>2 NO Contacts</b>	-	-	-	-
<b>1 NC / 1 NO Contacts Overlapping</b>	<b>608.5303.115</b> BI2-UV1Z W 	-	-	-

Technical Information	Slow Action	Snap Action	Slow Action	Snap Action
Maximum Switching Voltage	240V	240V	240V	240V
Max. Switching Amps (up to)*	10A	10A	10A	10A
B10d (up to)*	20 Million	20 Million	20 Million	20 Million
Mechanical Service Life (up to)*	10 x 10 <sup>6</sup>	10 x 10 <sup>6</sup>	10 x 10 <sup>6</sup>	10 x 10 <sup>6</sup>
Switching Frequency	≤ 100/min	≤ 100/min	≤ 100/min	≤ 100/min
Operating Temperature	-30 °C to +80 °C	-30 °C to +80 °C	-30 °C to +80 °C	-30 °C to +80 °C
Protection Rating	IP65	IP65	IP65	IP65
Utilization Category (up to)*	AC-15, Ue/Ue 240V 3A	AC-15, Ue/Ue 240V 3A	AC-15, Ue/Ue 240V 3A	AC-15, Ue/Ue 240V 3A
Rate Insulation Voltage	400VAC	400VAC	400VAC	400VAC

Approvals



**Special features/variants** (on request)

- Steel Roller Available

## X-ON Electronics

Largest Supplier of Electrical and Electronic Components

*Click to view similar products for [Limit Switches](#) category:*

*Click to view products by [Altech](#) manufacturer:*

Other Similar products are found below :

[6LS2-4PG](#) [5ML1-E1](#) [5ML31](#) [LZG1](#) [LZL1-6C](#) [622EN114-R](#) [622EN18-6](#) [622EN224-6B](#) [622EN230](#) [622EN237-R](#) [622EN69-3](#) [622EN85-RB](#)  
[MA-10019](#) [6PA109](#) [7LS51](#) [83547001](#) [83725002](#) [83830001](#) [83840001](#) [83840701](#) [83841001](#) [83870104](#) [83881140](#) [8AS42](#) [8LS10](#) [8LS125-](#)  
[4PG](#) [8LS152-4PGN20](#) [914CE16-3A](#) [914CE16-AQ](#) [914CE3-3L1](#) [915PA10](#) [91MCE16-P2O](#) [924CE16-Y3](#) [924CE1-S6](#) [924CE1-T25A](#)  
[924CE1-T3](#) [924CE1-T9A](#) [924CE2-T9](#) [924CE31-Y20-X5](#) [924CE31-Y3L1](#) [GL-10054](#) [GL-85710](#) [GL-85714](#) [GLAB26J2B](#) [GLDB03C-6](#)  
[GLZ324](#) [PS21R-NT11N7-YK0](#) [D4A-1106N](#) [D4A1201N](#) [D4A-3E02N](#)