

Spezifikation Specification

Schnappschalter-Kontakte
Snap- action contacts

Ruhestellung:
Free position Lo: max. 9,6 mm

Schaltpunkt:
Operating position Ls: 7,2 ±1,5 mm

Differenzweg:
Movement differential: max. 0,8 mm

Betätigungskraft:
Actuating force: max. 0,5 N

Überhubstellung:
Total travel position Le: min. 5,3 mm

Rückschaltkraft:
Release force: min. 0,05 N

Schutzart:
Degree of protection: IP 40

Kontakte:
Contacts: Silber-Legierung
Silver alloy

Anschlüsse:
Terminals: Messing, Silber-flash
Brass, silver flash

Mech. Lebensdauer:
Mechanical Life: 1E6

Anerkannte Standards:
Approved standards:

3.0A/125-250 VAC 6E3 / CO (NC/NO)



0.5A/250 VAC 5E4 / CO

2.0A/250 VAC 1E4 / NO/NC



Bedruckung Printing

Produktions-Datum: KW Jahr
Manufacturing date: CW Year

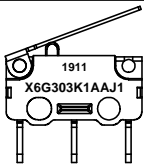

Typenschlüssel
Type code

Platinen-Einbaumaße PCB mounting dimensions

Drei Bohrungen, Ø1.2mm
Three, Ø1.2mm holes

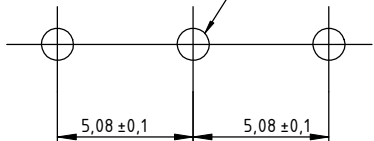

Befestigungsbohrungen Mounting holes

Zwei Bohrungen, Ø2mm
Two, Ø2mm holes

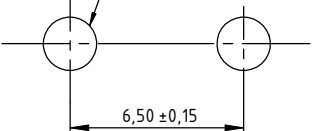

Einbauzeichnung Installation Drawing

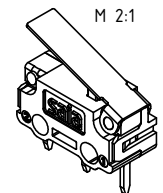
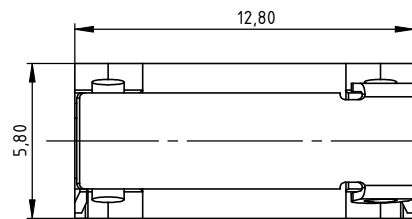
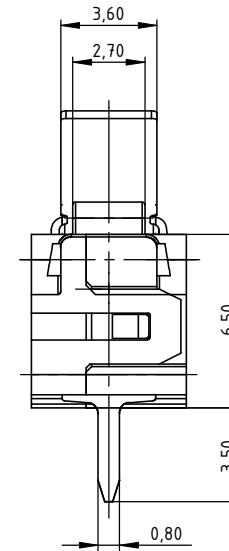
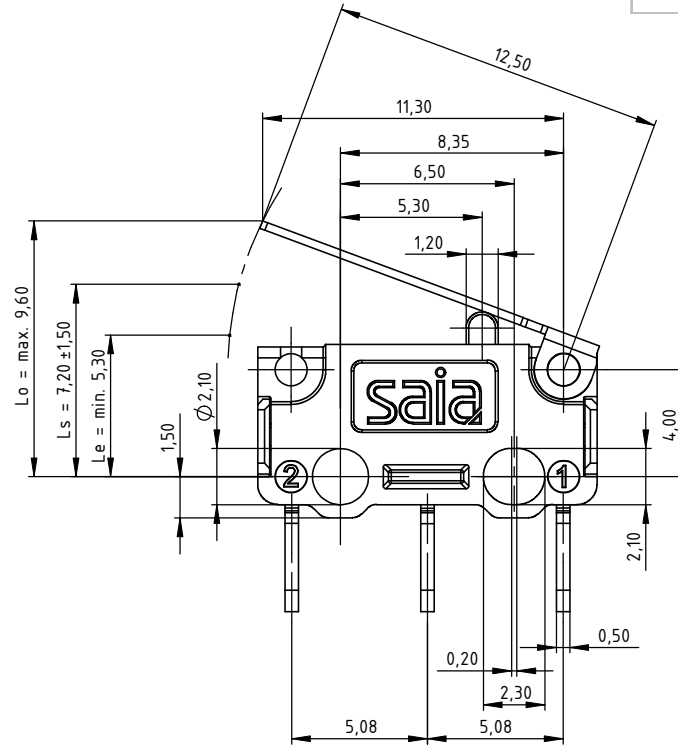

Schaltbild Circuit diagram

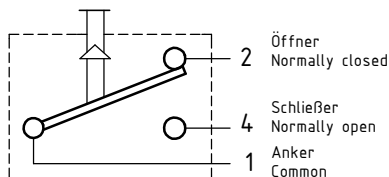

Für die korrekte Art des Einbaus ist der Anwender verantwortlich!
Responsibility for the proper fitting is taken by the handler!

ALT.	REF.	DESCRIPTION	DATE	BY
A	(Rev 01) A5/6 D2	Drg form new . Dims 1,20, 5,30 and ENEC19 logo added.	17.07.2012	Fre

Zur Freigabe durch den Kunden
For approval by customer

Allgemeintoleranzen nach DIN ISO 2768-1 (Auszug) general tolerances see DIN ISO 2768-1 (abridgement)					
Toleranzklasse grade of tolerance	0,5 bis/to 3	über/over 3 bis/to 6	über/over 6 bis/to 30	über/over 30 bis/to 120	über/over 120 bis/to 400
f (fein/fine)	±0.05	±0.05	±0.1	±0.15	±0.2
m (mittel/middle)	±0.1	±0.1	±0.2	±0.3	±0.5

Environmental Requirement as ESDC067					
DWN. BY	de04fre0	CHK. BY	de04fage0	APP. BY	
Date (yyyymmdd)	07.07.2011	Date (yyyymmdd)	20.08.2012	Date (yyyymmdd)	
MATERIAL:			Project-No.:	E2544	A3
			Type:	X6	
General Tolerance: ISO 2768-1 Class m (Unless specified)			ALL DIMENSIONS ARE IN MILLIMETRES		SCALE: 5:1 (2:1)
JOHNSON ELECTRIC GROUP OF COMPANIES ("JOHNSON ELECTRIC")			TITLE		Ultraminiature Microswitch
This document is the Property of Johnson Electric and the information therein contained is confidential. Unauthorised reproduction or other use thereof, whether directly or indirectly, in whole or in part, is strictly prohibited. All products made or otherwise derived directly or indirectly from this document are proprietary to Johnson Electric. © Copyright Johnson Electric Halver GmbH 2011. All rights reserved.			DWG No.		X6G303K1AAJ1_C 1434-9CE0014EP
					SHEET 1 OF 1

C _{pk}	Characteristics
> 1.67	Key Product
> 1.33	Customer Significant
> 1.00	
Not Required	

X-ON Electronics

Largest Supplier of Electrical and Electronic Components

Click to view similar products for [Basic / Snap Action Switches](#) category:

Click to view products by [Saia-Burgess](#) manufacturer:

Other Similar products are found below :

[83228001](#) [01.098.1358.1](#) [602EN1-6B](#) [602EN532](#) [602EN535-RB](#) [602HE5-RB1](#) [604HE162](#) [604HE223-6B](#) [624HE17-RB](#) [6HM89](#) [6PA78-JM](#)
[6SE1](#) [6SX1-H58](#) [70500840](#) [MBD5B1](#) [MBH2731](#) [73-316-0012](#) [79211759](#) [79211923](#) [79218589](#) [7AS12](#) [ML-1155](#) [ML-1376](#) [831010C3.0](#)
[831060C3.TL](#) [831090C2.EL](#) [83131904](#) [84212012](#) [8AS239](#) [8HM73-3](#) [903VB1-PG](#) [914CE1-6G](#) [PL-100](#) [11SM1077-H4](#) [11SM1077-H58](#)
[11SM1-TN107](#) [11SM405](#) [11SM703-T](#) [11SM8423-H2](#) [11SX37-T](#) [11SX48-H58](#) [11SX55-H58](#) [11SM2442-T](#) [11SM76-T](#) [11SM77-H58](#)
[11SM77-T](#) [11SM863-T](#) [11SM866](#) [11SX47-H58](#) [A7CN-1M-1-LEFT](#)