

November 2015

Carbon Emission
CO₂ 1.86g
MLCC(02A104M) 1piece

RoHS+Halogen
Compliant
Ecoparts

MULTILAYER CERAMIC CAPACITORS



SAMSUNG
ELECTRO-MECHANICS





We declare that all our MLCCs are produced in accordance with EU ROHS and REACH Directive.

1. RoHS Compliance and restriction of Br

The following restricted materials are not used in packaging materials as well as products in compliance with the law and restriction.
- Cd, Pb, Hg, Cr6+, As, Br and the compounds, PCB, asbestos

2. No use of materials breaking Ozone layer

The following ODS materials are not used in our fabrication process.
- ODS material : Freon, Haron, 1-1-1 TCE, CCl₄, HCFC

If you want more detailed Information, Please Visit Samsung Electro-mechanics Website
[<http://www.semlcr.com>]

Please, see the last page of this catalog for our environmental certification list.

CONTENTS

| | | |
|--|----|--|
| Part Numbering System | 4 | Part Numbering System |
| Standard & High Capacitors | 6 | Standard & High Capacitors |
| Super Small Size Capacitors | 30 | Super Small Size Capacitors |
| High-Q Capacitors | 35 | High-Q Capacitors |
| Medium-High Voltage Capacitors | 36 | Medium-High Voltage Capacitors |
| Array Type Capacitors | 47 | Array Type Capacitors |
| Low ESL Capacitors | 50 | Low ESL Capacitors |
| Reliability Test Condition | 53 | Reliability Test Condition |
| Premium Capacitors for Automotive Applications | 60 | Premium Capacitors for Automotive Applications |
| Packaging Specification | 72 | Packaging Specification |
| Application Manual for Surface Mounting | 76 | Application Manual for Surface Mounting |

Part Numbering System

CL 10 A 106 M P 8 N N N C
1 2 3 4 5 6 7 8 9 10 11

1. SERIES CODE _____

CL = Multi layer Ceramic Capacitors

2. SIZE CODE — inch(mm) _____

02 = 01005(0402) 21 = 0805(2012) 43 = 1812(4532)
 03 = 0201(0603) 31 = 1206(3216) 55 = 2220(5750)
 05 = 0402(1005) 32 = 1210(3225)
 10 = 0603(1608) 42 = 1808(4520)

3. DIELECTRIC CODE _____

| Class I | Class II |
|---------|--|
| C = COG | A = X5R F = Y5V B = X7R X = X6S Y = X7S Z = X7T |

4. CAPACITANCE CODE _____

Capacitance expressed in pF. 2 significant digits plus number of zeros.
 example) 106 = $10 \times 10^6 = 10000000\text{pF}$
 For Values < 10pF, Letter R denotes decimal point
 example) 1R5 = 1.5pF

5. TOLERANCE CODE _____

B = $\pm 0.1\text{pF}$ F = $\pm 1\text{pF}, \pm 1\%$ * K = $\pm 10\%$
 C = $\pm 0.25\text{pF}$ G = $\pm 2\%$ M = $\pm 20\%$
 D = $\pm 0.5\text{pF}$ J = $\pm 5\%$ Z = $+80/-20\%$

*For Values $\leq 10\text{pF}$, F = $\pm 1\text{pF}$
 Values $> 10\text{pF}$, F = $\pm 1\%$

6. RATED VOLTAGE CODE _____

R = 4V O = 16V B = 50V E = 250V H = 630V K = 3000V
 Q = 6.3V A = 25V C = 100V F = 350V I = 1000V
 P = 10V L = 35V D = 200V G = 500V J = 2000V

7. THICKNESS CODE _____

2 = 0.20mm A = 0.65mm F = 1.25mm L = 3.20mm S = 1.35mm
 3 = 0.30mm C = 0.85mm H = 1.60mm M = 1.15mm U = 1.80mm
 5 = 0.50mm D = 1.00mm I = 2.00mm P = 1.15mm V = 2.50mm
 8 = 0.80mm E = 1.10mm J = 2.50mm Q = 1.25mm Y = 1.25mm
 9 = 0.90mm

8. INNER ELECTRODE / TERMINATION / PLATING CODE _____

A = Normal Product Pd / Ag / Ni barrier / Sn 100%
 N = Normal Product Ni / Cu / Ni barrier / Sn 100%
 G = Normal Product Cu / Cu / Ni barrier / Sn 100%
 L = Low profile Ni / Cu / Ni barrier / Sn 100%
 S = Normal Product Ni / Cu / Soft termination / Ni barrier / Sn 100%

9. PRODUCT CODE _____

N = Normal
 A = Array(4-element)
 B = Array(4-element)
 L = LICC
 J = SLIC

| | | *Size tolerance | | | | | |
|------|------|-----------------|------------|------------|------------|------------|------------|
| Code | Size | 01005(0402) | 0201(0603) | 0402(1005) | 0603(1608) | 0805(2012) | 1206(3216) |
| | S | | ± 0.03 | ± 0.05 | ± 0.07 | ± 0.07 | |
| Q | | ± 0.05 | ± 0.07 | ± 0.10 | ± 0.15 | ± 0.15 | |
| R | | ± 0.07 | ± 0.09 | ± 0.15 | ± 0.20 | ± 0.20 | |
| U | | ± 0.09 | | ± 0.20 | ± 0.25 | ± 0.30 | |
| Z | | | | ± 0.40 | ± 0.30 | | |
| 9 | | | | ± 0.30 | | | |

10. CONTROL CODE _____

N = Reserved for future use

11. PACKAGING CODE _____

B = Bulk O = Cardboard Tape, 10" Reel E = Embossed Type, 7" Reel
 P = Bulk Case D = Cardboard Tape, 13" Reel(10,000ea) G = Embossed Type, 7" Reel(3,000ea)
 C = Cardboard Tape, 7" Reel L = Cardboard Tape, 13" Reel(15,000ea) F = Embossed Type, 13" Reel
 H = Cardboard Tape, 7" Reel(15,000ea) S = Embossed Type, 10" Reel
 8 = Cardboard Tape, 7" Reel Z = Cardboard Type, 7" Reel(Chip aligned for horizontal SMT)
 Y = Cardboard Type, 7" Reel(Chip aligned for vertical SMT)

Class I (Temperature Compensation)

| Symbol | EIA Code | Operation Temperature Range(℃) | Temperature Coefficient Range(ppm/℃) |
|--------|----------|--------------------------------|--------------------------------------|
| C | C0G | -55 ~ +125 | 0±30 |

***Class II** (High Dielectric Constant)

| Symbol | EIA Code | Operation Temperature Range(℃) | Capacitance Change(ΔC%) |
|--------|----------|--------------------------------|-------------------------|
| A | X5R | -55 ~ + 85 | ±15 |
| B | X7R | -55 ~ +125 | ±15 |
| X | X6S | -55 ~ +105 | ±22 |
| F | Y5V | -30 ~ + 85 | -82 ~ +22 |
| Y | X7S | -55 ~ +125 | ±22 |
| Z | X7T | -55 ~ +125 | -33 ~ +22 |

**

| Series | TC | Capacitance Step | | | | | | | | | | | |
|--------|-----|------------------|-----|-----|-----|-----|-----|-----|-----|-----|-----|-----|-----|
| E-3 | Y5V | 1.0 | | | | 2.2 | | | | 4.7 | | | |
| E-6 | X5R | 1.0 | 1.5 | 2.2 | 3.3 | 4.7 | 6.8 | 1.0 | 1.2 | 1.5 | 1.8 | 2.2 | 2.7 |
| | X7R | | | | | | | | | | | | |
| | X6S | | | | | | | | | | | | |
| | X7S | | | | | | | | | | | | |
| X7T | | | | | | | | | | | | | |
| E-12 | C0G | 1.0 | 1.2 | 1.5 | 1.8 | 2.2 | 2.7 | 3.3 | 3.9 | 4.7 | 5.6 | 6.8 | 8.2 |

| Size | Code | Thickness(mm) | Spec(mm) | Size | Code | Thickness(mm) | Spec(mm) |
|-------------|------|---------------|------------|------------|------------|---------------|----------|
| 01005(0402) | 2 | 0.20 | ±0.02 | 1210(3225) | C | 0.85 | ±0.10* |
| 0201(0603) | 3 | 0.30 | ±0.03 | | g | 0.90 | ±0.10* |
| 0402(1005) | 3 | 0.30 | ±0.03* | | F | 1.25 | ±0.20 |
| | 5 | 0.50 | ±0.05 | | S | 1.35 | ±0.15 |
| 0603(1608) | 5 | 0.50 | +0.0/-0.1* | | H | 1.60 | ±0.20 |
| | 8 | 0.80 | ±0.10 | | U | 1.80 | ±0.20* |
| 0805(2012) | A | 0.65 | ±0.10 | | I | 2.00 | ±0.20 |
| | C | 0.85 | ±0.10 | | J | 2.50 | ±0.20 |
| | C | 0.85 | ±0.10* | | V | 2.50 | ±0.30 |
| | M | 1.15 | ±0.10 | | 1808(4520) | F | 1.25 |
| | F | 1.25 | ±0.10 | H | | 1.60 | ±0.20 |
| | Q | 1.25 | ±0.15 | I | | 2.00 | ±0.20 |
| | Y | 1.25 | ±0.20 | F | | 1.25 | ±0.20 |
| 1206(3216) | C | 0.85 | ±0.15 | H | 1.60 | ±0.20 | |
| | C | 0.85 | ±0.10* | 1812(4532) | I | 2.00 | ±0.20 |
| | E | 1.10 | ±0.15 | | J | 2.50 | ±0.20 |
| | E | 1.10 | ±0.10* | | L | 3.20 | ±0.30 |
| | P | 1.15 | ±0.10* | | 2220(5750) | H | 1.60 |
| | M | 1.15 | ±0.15 | I | | 2.00 | ±0.20 |
| | F | 1.25 | ±0.15 | J | | 2.50 | ±0.20 |
| | H | 1.60 | ±0.20 | L | | 3.00 | ±0.30 |

■ * Mark is only applicable to "L" code, 12th code in part number.

■ Please discuss with sales person with regard to Pd products.

Part Numbering System

Standard & High Capacitors

Super Small Size Capacitors

High-Q Capacitors

Medium-High Voltage Capacitors

Array Type Capacitors

Low ESL Capacitors

Reliability Test Condition

Premium Capacitors for Automotive Applications

Packaging Specification

Application Manual for Surface Mounting

Standard & High Capacitors



Feature

- Wide selection of size : from 0402 to 2220
- Highly reliable tolerance and high speed automatic chip placement on PCBs
- Wide capacitance range
- Wide temperature compensation and voltage range : from COG to Y5V and from 6.3V to 50V
- Highly reliable performance
- Highly resistant termination metal
- Tape & reel for surface mount assembly

Application

- HHP, DSC, DVC, LCD, TV, Memory Module, PDA, Game Machine
- Desktop PC, Note PC, HHP, DC-DC Converter, DSC
- Tuner (Product code C is suitable.)

Structure and Dimensions



| Size Code | EIA Code | Dimension(mm) | | | | |
|-----------|----------|---------------|-----------|------------------|----------------|--------------|
| | | L | W | T | Thickness Code | BW |
| 05 | 0402 | 1.00±0.05 | 0.50±0.05 | 0.50±0.05 | 5 | 0.25±0.10 |
| 10 | 0603 | 1.60±0.10 | 0.80±0.10 | 0.50±0.0/-0.1(*) | 5 | 0.30±0.20 |
| | | 1.60±0.10 | 0.80±0.10 | 0.80±0.10 | 8 | |
| 21 | 0805 | 2.00±0.10 | 1.25±0.10 | 0.85±0.10 | C | 0.5±0.2/-0.3 |
| | | 2.00±0.10 | 1.25±0.10 | 1.15±0.10 | M | |
| | | 2.00±0.10 | 1.25±0.10 | 1.25±0.10 | F | |
| | | 2.00±0.15 | 1.25±0.15 | 1.25±0.15 | Q | |
| | | 2.00±0.20 | 1.25±0.20 | 1.25±0.20 | Y | |
| 31 | 1206 | 3.20±0.20 | 1.60±0.20 | 0.60±0.10(*) | 6 | 0.50±0.30 |
| | | 3.20±0.15 | 1.60±0.15 | 0.85±0.15 | C | |
| | | 3.20±0.20 | 1.60±0.20 | 0.85±0.10(*) | C | |
| | | 3.20±0.20 | 1.60±0.20 | 1.15±0.10(*) | P | |
| | | 3.20±0.15 | 1.60±0.15 | 1.25±0.15 | F | |
| 32 | 1210 | 3.20±0.20 | 1.60±0.20 | 1.60±0.20 | H | 0.60±0.30 |
| | | 3.20±0.30 | 2.50±0.20 | 0.85±0.10(*) | C | |
| | | 3.20±0.30 | 2.50±0.20 | 0.90±0.10(*) | 9 | |
| | | 3.20±0.30 | 2.50±0.20 | 1.60±0.20 | H | |
| | | 3.20±0.30 | 2.50±0.20 | 1.80±0.20(*) | U | |
| | | 3.20±0.30 | 2.50±0.20 | 2.00±0.20 | I | |
| 42 | 1808 | 3.20±0.30 | 2.50±0.20 | 2.50±0.20 | J | 0.80±0.30 |
| | | 3.20±0.40 | 2.50±0.30 | 2.50±0.30 | V | |
| | | 4.50±0.40 | 2.00±0.20 | 1.25±0.20 | F | |
| 43 | 1812 | 4.50±0.40 | 2.00±0.20 | 1.40±0.20 | G | 0.80±0.30 |
| | | 4.50±0.40 | 2.00±0.20 | 2.00±0.20 | I | |
| | | 4.50±0.40 | 3.20±0.30 | 1.25±0.20 | F | |
| 55 | 2220 | 4.50±0.40 | 3.20±0.30 | 2.50±0.20 | J | 0.80±0.30 |
| | | 4.50±0.40 | 3.20±0.30 | 3.20±0.30 | L | |
| | | 5.70±0.40 | 5.00±0.40 | 2.50±0.20 | J | |
| | | 5.70±0.40 | 5.00±0.40 | 3.20±0.30 | L | 1.00±0.30 |

■ * Mark is only applicable to "L" code, 12th code in part number.

Standard & High Capacitance (COG)

| Size(mm) | Vr(V) | Capacitance | | | | | | | | | | | | | | | | | | | | | |
|------------|-------|-------------|---|----|----|----|-----|-----|-----|-----|-----|---|-----|-----|-----|-----|----|----|----|----|----|----|-----|
| | | pF | | | | | | | | | nF | | | | | | | | | | | | |
| | | 0.5 | 1 | 10 | 22 | 47 | 100 | 220 | 330 | 470 | 560 | 1 | 2.2 | 3.3 | 4.7 | 6.8 | 10 | 22 | 27 | 33 | 47 | 68 | 100 |
| 0402(1005) | 25 | █ | | | | | | | | | | | | | | | | | | | | | |
| | 50 | █ | | | | | | | | | | | | | | | | | | | | | |
| 0603(1608) | 25 | █ | | | | | | | | | | | | | | | | | | | | | |
| | 50 | █ | | | | | | | | | | | | | | | | | | | | | |
| 0805(2012) | 25 | | | | | | | | | | █ | | | | | | | | | | | | |
| | 50 | █ | | | | | | | | | | | | | | | | | | | | | |
| 1206(3216) | 16 | | | | | | | | | | | | | █ | | | | | | | | | |
| | 25 | | | | | | | | | | █ | | | | | | | | | | | | |
| | 50 | █ | | | | | | | | | | | | | | | | | | | | | |
| 1210(3225) | 50 | | | | | | | | | | █ | | | | | | | | | | | | |
| 1812(4532) | 25 | | | | | | | | | | | | | █ | | | | | | | | | |
| | 50 | | | | | | | | | | █ | | | | | | | | | | | | |
| 2220(5750) | 50 | | | | | | | | | | | | | █ | | | | | | | | | |

- Part Numbering System
- Standard & High Capacitors
- Super Small Size Capacitors
- High-Q Capacitors
- Medium-High Voltage Capacitors
- Array Type Capacitors
- Low ESL Capacitors
- Reliability Test Condition
- Premium Capacitors for Automotive Applications
- Packaging Specification
- Application Manual for Surface Mounting

Standard & High Capacitance-Low Profile (X5R)

| Size(mm) | Tmax (mm) | Vr(V) | Capacitance (μ F) | | | | | | |
|------------|-----------|-------|------------------------|-----|-------------|-----|-----|------------|--|
| | | | 1 | 2.2 | 4.7 | 10 | 22 | 47 | |
| 0402(1005) | 0.33 | 6.3 | X6S | | (Tmax=0.35) | | | | |
| | | 10 | | | | | | | |
| | | 16 | | | | | | | |
| 0603(1608) | 0.5 | 6.3 | | | | | | | |
| | | 10 | | | | | | | |
| | | 16 | | | | | | | |
| | | 25 | | | | | | | |
| 0805(2012) | 0.7 | 10 | | | | | | | |
| | | 16 | | | | | | | |
| | | 25 | | | | | | | |
| | 0.85 | 25 | | | | | | | |
| | | 0.95 | 4 | | | | | (Tmax=1.0) | |
| | | | 6.3 | | | | | (Tmax=1.0) | |
| 0.95 | 10 | | | | | | | | |
| | 16 | | | | | | | | |
| | 25 | | | | | X6S | | | |
| 1206(3216) | 0.7 | 10 | | | | | | | |
| | | 0.95 | 6.3 | | | | | | |
| | 10 | | | | | | | | |
| | 16 | | | | | | | | |
| | 25 | | | | | | X6S | | |
| | 50 | | (Tmax=1.0) | | (Tmax=1.0) | | | | |
| | 100 | | (Tmax=1.0) | | | | | | |
| 1210(3225) | 0.95 | 16 | | | | | | | |
| | | 2.0 | 25 | | | | | | |
| | 35 | | | | | | | | |
| | 50 | | | | | | | | |

- Part Numbering System
- Standard & High Capacitors
- Super Small Size Capacitors
- High-Q Capacitors
- Medium-High Voltage Capacitors
- Array Type Capacitors
- Low ESL Capacitors
- Reliability Test Condition
- Premium Capacitors for Automotive Applications
- Packaging Specification
- Application Manual for Surface Mounting

Standard & High Capacitance (X7R)

| Size(mm) | Vr(V) | Capacitance (μF) | | | | | | | | | | |
|------------|-------|-------------------------|------|------|-----|-----|-----|-----|----|----|-----|-----|
| | | 0.1 | 0.22 | 0.47 | 1 | 2.2 | 4.7 | 10 | 22 | 47 | 100 | |
| 0402(1005) | 6.3 | █ | █ | █ | █ | █ | █ | █ | █ | █ | █ | █ |
| | 10 | █ | █ | █ | X7S | █ | █ | █ | █ | █ | █ | █ |
| | 16 | █ | █ | █ | █ | █ | █ | █ | █ | █ | █ | █ |
| 0603(1608) | 6.3 | █ | █ | █ | █ | █ | █ | █ | █ | █ | █ | █ |
| | 10 | █ | █ | █ | █ | █ | █ | █ | █ | █ | █ | █ |
| | 16 | █ | █ | █ | █ | █ | █ | █ | █ | █ | █ | █ |
| | 25 | █ | █ | █ | █ | █ | █ | █ | █ | █ | █ | █ |
| | 50 | █ | █ | █ | █ | █ | █ | █ | █ | █ | █ | █ |
| 0805(2012) | 6.3 | █ | █ | █ | █ | █ | █ | █ | █ | █ | █ | █ |
| | 10 | █ | █ | █ | █ | █ | █ | █ | █ | █ | █ | █ |
| | 16 | █ | █ | █ | █ | █ | █ | █ | █ | █ | █ | █ |
| | 25 | █ | █ | █ | █ | █ | █ | X7S | █ | █ | █ | █ |
| | 35 | █ | █ | █ | █ | █ | █ | █ | █ | █ | █ | █ |
| | 50 | █ | █ | █ | █ | █ | █ | █ | █ | █ | █ | █ |
| 1206(3216) | 6.3 | █ | █ | █ | █ | █ | █ | █ | █ | █ | █ | █ |
| | 10 | █ | █ | █ | █ | █ | █ | █ | █ | █ | █ | █ |
| | 16 | █ | █ | █ | █ | █ | █ | █ | █ | █ | █ | █ |
| | 25 | █ | █ | █ | █ | █ | █ | █ | █ | █ | █ | █ |
| | 35 | █ | █ | █ | █ | █ | █ | █ | █ | █ | █ | █ |
| | 50 | █ | █ | █ | █ | █ | █ | █ | █ | █ | █ | █ |
| 1210(3225) | 6.3 | █ | █ | █ | █ | █ | █ | █ | █ | █ | █ | X7T |
| | 10 | █ | █ | █ | █ | █ | █ | █ | █ | █ | █ | █ |
| | 16 | █ | █ | █ | █ | █ | █ | █ | █ | █ | █ | █ |
| | 25 | █ | █ | █ | █ | █ | █ | █ | █ | █ | █ | █ |
| | 50 | █ | █ | █ | █ | █ | █ | █ | █ | █ | █ | █ |

- Part Numbering System
- Standard & High Capacitors
- Super Small Size Capacitors
- High-Q Capacitors
- Medium-High Voltage Capacitors
- Array Type Capacitors
- Low ESL Capacitors
- Reliability Test Condition
- Premium Capacitors for Automotive Applications
- Packaging Specification
- Application Manual for Surface Mounting



Standard & High capacitance (Y5V)

| Size(mm) | Vr(V) | Capacitance (μF) | | | | | | | | | |
|------------|-------|-------------------------------|------|------|---|-----|-----|----|----|----|--|
| | | 0.1 | 0.22 | 0.47 | 1 | 2.2 | 4.7 | 10 | 22 | 47 | |
| 0402(1005) | 6.3 | | | | | | | | | | |
| | 10 | | | | | | | | | | |
| | 16 | | | | | | | | | | |
| | 25 | | | | | | | | | | |
| 0603(1608) | 6.3 | | | | | | | | | | |
| | 10 | | | | | | | | | | |
| | 16 | | | | | | | | | | |
| | 25 | | | | | | | | | | |
| | 50 | | | | | | | | | | |
| 0805(2012) | 6.3 | | | | | | | | | | |
| | 10 | | | | | | | | | | |
| | 16 | | | | | | | | | | |
| | 25 | | | | | | | | | | |
| | 50 | | | | | | | | | | |
| 1206(3216) | 10 | | | | | | | | | | |
| | 16 | | | | | | | | | | |
| | 25 | | | | | | | | | | |
| | 50 | | | | | | | | | | |
| 1210(3225) | 6.3 | | | | | | | | | | |
| | 10 | | | | | | | | | | |
| | 16 | | | | | | | | | | |
| | 25 | | | | | | | | | | |
| | 35 | | | | | | | | | | |
| | 50 | | | | | | | | | | |
| | | | | | | | | | | | |

Standard & High capacitance - Low Profile (Y5V)

| Size(mm) | Vr(V) | Capacitance (μF) | | | | | | |
|------------|-------|-------------------------------|-----|-----|----|----|----|--|
| | | 1 | 2.2 | 4.7 | 10 | 22 | 47 | |
| 0805(2012) | 6.3 | | | | | | | |
| | 10 | | | | | | | |

Product Lineup (Standard & High Capacitors-C0G)

| | Part Number | Size L x W (mm) | Capacitance | Rated Voltage (Vdc) | Capacitance Tolerance | Thickness Max.(mm) |
|----|------------------|--------------------|-------------|------------------------|-----------------------|--------------------|
| 1 | CL05C0R5CB5NNN □ | 1.00×0.50 | 0.5pF | 50 | ±0.25pF | 0.55 |
| 2 | CL05CR75CB5NNN □ | | 0.75pF | 50 | ±0.25pF | 0.55 |
| 3 | CL05C010CB5NNN □ | | 1.0pF | 50 | ±0.25pF | 0.55 |
| 4 | CL05C1R2CB5NNN □ | | 1.2pF | 50 | ±0.25pF | 0.55 |
| 5 | CL05C1R5CB5NNN □ | | 1.5pF | 50 | ±0.25pF | 0.55 |
| 6 | CL05C1R8CB5NNN □ | | 1.8pF | 50 | ±0.25pF | 0.55 |
| 7 | CL05C020CB5NNN □ | | 2.0pF | 50 | ±0.25pF | 0.55 |
| 8 | CL05C2R2CB5NNN □ | | 2.2pF | 50 | ±0.25pF | 0.55 |
| 9 | CL05C2R4CB5NNN □ | | 2.4pF | 50 | ±0.25pF | 0.55 |
| 10 | CL05C2R5CB5NNN □ | | 2.5pF | 50 | ±0.25pF | 0.55 |
| 11 | CL05C2R7CB5NNN □ | | 2.7pF | 50 | ±0.25pF | 0.55 |
| 12 | CL05C030CB5NNN □ | | 3.0pF | 50 | ±0.25pF | 0.55 |
| 13 | CL05C3R3CB5NNN □ | | 3.3pF | 50 | ±0.25pF | 0.55 |
| 14 | CL05C3R5CB5NNN □ | | 3.5pF | 50 | ±0.25pF | 0.55 |
| 15 | CL05C3R6CB5NNN □ | | 3.6pF | 50 | ±0.25pF | 0.55 |
| 16 | CL05C3R9CB5NNN □ | | 3.9pF | 50 | ±0.25pF | 0.55 |
| 17 | CL05C040CB5NNN □ | | 4.0pF | 50 | ±0.25pF | 0.55 |
| 18 | CL05C4R3CB5NNN □ | | 4.3pF | 50 | ±0.25pF | 0.55 |
| 19 | CL05C4R7CB5NNN □ | | 4.7pF | 50 | ±0.25pF | 0.55 |
| 20 | CL05C050DB5NNN □ | | 5.0pF | 50 | ±0.5pF | 0.55 |
| 21 | CL05C5R6DB5NNN □ | | 5.6pF | 50 | ±0.5pF | 0.55 |
| 22 | CL05C060DB5NNN □ | | 6.0pF | 50 | ±0.5pF | 0.55 |
| 23 | CL05C6R2DB5NNN □ | | 6.2pF | 50 | ±0.5pF | 0.55 |
| 24 | CL05C6R8DB5NNN □ | | 6.8pF | 50 | ±0.5pF | 0.55 |
| 25 | CL05C070DB5NNN □ | | 7.0pF | 50 | ±0.5pF | 0.55 |
| 26 | CL05C080DB5NNN □ | | 8.0pF | 50 | ±0.5pF | 0.55 |
| 27 | CL05C8R2DB5NNN □ | | 8.2pF | 50 | ±0.5pF | 0.55 |
| 28 | CL05C090DB5NNN □ | | 9.0pF | 50 | ±0.5pF | 0.55 |
| 29 | CL05C9R1DB5NNN □ | | 9.1pF | 50 | ±0.5pF | 0.55 |
| 30 | CL05C100JB5NNN □ | | 10pF | 50 | ±5% | 0.55 |
| 31 | CL05C110JB5NNN □ | | 11pF | 50 | ±5% | 0.55 |
| 32 | CL05C120JB5NNN □ | | 12pF | 50 | ±5% | 0.55 |
| 33 | CL05C130JB5NNN □ | | 13pF | 50 | ±5% | 0.55 |
| 34 | CL05C150JB5NNN □ | | 15pF | 50 | ±5% | 0.55 |
| 35 | CL05C160JB5NNN □ | | 16pF | 50 | ±5% | 0.55 |
| 36 | CL05C180JB5NNN □ | | 18pF | 50 | ±5% | 0.55 |
| 37 | CL05C200JB5NNN □ | | 20pF | 50 | ±5% | 0.55 |
| 38 | CL05C220JA5NNN □ | | 22pF | 25 | ±5% | 0.55 |
| 39 | CL05C220JB5NNN □ | | 22pF | 50 | ±5% | 0.55 |
| 40 | CL05C240JB5NNN □ | | 24pF | 50 | ±5% | 0.55 |
| 41 | CL05C270JB5NNN □ | | 27pF | 50 | ±5% | 0.55 |
| 42 | CL05C270JA5NNN □ | | 27pF | 25 | ±5% | 0.55 |
| 43 | CL05C300JB5NNN □ | | 30pF | 50 | ±5% | 0.55 |
| 44 | CL05C330JB5NNN □ | | 33pF | 50 | ±5% | 0.55 |
| 45 | CL05C360JB5NNN □ | | 36pF | 50 | ±5% | 0.55 |
| 46 | CL05C390JB5NNN □ | | 39pF | 50 | ±5% | 0.55 |
| 47 | CL05C430JB5NNN □ | | 43pF | 50 | ±5% | 0.55 |
| 48 | CL05C470JB5NNN □ | | 47pF | 50 | ±5% | 0.55 |
| 49 | CL05C510JB5NNN □ | | 51pF | 50 | ±5% | 0.55 |
| 50 | CL05C560JB5NNN □ | | 56pF | 50 | ±5% | 0.55 |

※ □ mark means packaging code. If you want to learn the code or quantity in detail, please see p74.

Part Numbering System

Standard & High Capacitors

Super Small Size Capacitors

High-Q Capacitors

Medium-High Voltage Capacitors

Array Type Capacitors

Low ESL Capacitors

Reliability Test Condition

Premium Capacitors for Automotive Applications

Packaging Specification

Application Manual for Surface Mounting



Product Lineup (Standard & High Capacitors-C0G)

| | Part Number | Size L x W (mm) | Capacitance | Rated Voltage (Vdc) | Capacitance Tolerance | Thickness Max.(mm) |
|----|------------------|--------------------|-------------|---------------------------|--------------------------|-----------------------|
| 51 | CL05C620JB5NNN □ | 1.00×0.50 | 62pF | 50 | ±5% | 0.55 |
| 52 | CL05C680JB5NNN □ | | 68pF | 50 | ±5% | 0.55 |
| 53 | CL05C750JB5NNN □ | | 75pF | 50 | ±5% | 0.55 |
| 54 | CL05C820JB5NNN □ | | 82pF | 50 | ±5% | 0.55 |
| 55 | CL05C910JB5NNN □ | | 91pF | 50 | ±5% | 0.55 |
| 56 | CL05C101JB5NNN □ | | 100pF | 50 | ±5% | 0.55 |
| 57 | CL05C121JB5NNN □ | | 120pF | 50 | ±5% | 0.55 |
| 58 | CL05C151JB5NNN □ | | 150pF | 50 | ±5% | 0.55 |
| 59 | CL05C181JB5NNN □ | | 180pF | 50 | ±5% | 0.55 |
| 60 | CL05C201JB5NNN □ | | 200pF | 50 | ±5% | 0.55 |
| 61 | CL05C221JB5NNN □ | | 220pF | 50 | ±5% | 0.55 |
| 62 | CL05C271JB5NNN □ | | 270pF | 50 | ±5% | 0.55 |
| 63 | CL05C331JB5NNN □ | | 330pF | 50 | ±5% | 0.55 |
| 64 | CL05C391JB5NNN □ | | 390pF | 50 | ±5% | 0.55 |
| 65 | CL05C471JB5NNN □ | | 470pF | 50 | ±5% | 0.55 |
| 66 | CL05C471JO5NNN □ | | 470pF | 16 | ±5% | 0.55 |
| 67 | CL05C681JB5NNN □ | | 680pF | 50 | ±5% | 0.55 |
| 68 | CL05C821JB5NNN □ | | 820pF | 50 | ±5% | 0.55 |
| 69 | CL05C102JB5NNN □ | | 1nF | 50 | ±5% | 0.55 |
| 70 | CL05C102JA5NNN □ | | 1nF | 25 | ±5% | 0.55 |
| 71 | CL05C102JO5NNN □ | | 1nF | 16 | ±5% | 0.55 |
| 1 | CL10C0R3CB8NNN □ | 1.60×0.80 | 0.3pF | 50 | ±0.25pF | 0.90 |
| 2 | CL10C0R5CB8NNN □ | | 0.5pF | 50 | ±0.25pF | 0.90 |
| 3 | CL10CR75CB8NNN □ | | 0.75pF | 50 | ±0.25pF | 0.90 |
| 4 | CL10C010CB8NNN □ | | 1.0pF | 50 | ±0.25pF | 0.90 |
| 5 | CL10C1R2CB8NNN □ | | 1.2pF | 50 | ±0.25pF | 0.90 |
| 6 | CL10C1R5CB8NNN □ | | 1.5pF | 50 | ±0.25pF | 0.90 |
| 7 | CL10C1R8CB8NNN □ | | 1.8pF | 50 | ±0.25pF | 0.90 |
| 8 | CL10C020CB8NNN □ | | 2.0pF | 50 | ±0.25pF | 0.90 |
| 9 | CL10C2R2CB8NNN □ | | 2.2pF | 50 | ±0.25pF | 0.90 |
| 10 | CL10C2R4CB8NNN □ | | 2.4pF | 50 | ±0.25pF | 0.90 |
| 11 | CL10C2R5CB8NNN □ | | 2.5pF | 50 | ±0.25pF | 0.90 |
| 12 | CL10C2R7CB8NNN □ | | 2.7pF | 50 | ±0.25pF | 0.90 |
| 13 | CL10C030CB8NNN □ | | 3.0pF | 50 | ±0.25pF | 0.90 |
| 14 | CL10C3R3CB8NNN □ | | 3.3pF | 50 | ±0.25pF | 0.90 |
| 15 | CL10C3R5CB8NNN □ | | 3.5pF | 50 | ±0.25pF | 0.90 |
| 16 | CL10C3R6CB8NNN □ | | 3.6pF | 50 | ±0.25pF | 0.90 |
| 17 | CL10C3R9CB8NNN □ | | 3.9pF | 50 | ±0.25pF | 0.90 |
| 18 | CL10C040CB8NNN □ | | 4.0pF | 50 | ±0.25pF | 0.90 |
| 19 | CL10C4R3CB8NNN □ | | 4.3pF | 50 | ±0.25pF | 0.90 |
| 20 | CL10C4R7CB8NNN □ | | 4.7pF | 50 | ±0.25pF | 0.90 |
| 21 | CL10C050DB8NNN □ | | 5.0pF | 50 | ±0.5pF | 0.90 |
| 22 | CL10C5R6DB8NNN □ | | 5.6pF | 50 | ±0.5pF | 0.90 |
| 23 | CL10C060DB8NNN □ | | 6.0pF | 50 | ±0.5pF | 0.90 |
| 24 | CL10C6R2DB8NNN □ | | 6.2pF | 50 | ±0.5pF | 0.90 |
| 25 | CL10C6R8DB8NNN □ | | 6.8pF | 50 | ±0.5pF | 0.90 |
| 26 | CL10C070DB8NNN □ | | 7.0pF | 50 | ±0.5pF | 0.90 |
| 27 | CL10C7R5DB8NNN □ | | 7.5pF | 50 | ±0.5pF | 0.90 |
| 28 | CL10C080DB8NNN □ | | 8.0pF | 50 | ±0.5pF | 0.90 |
| 29 | CL10C8R2DB8NNN □ | | 8.2pF | 50 | ±0.5pF | 0.90 |

※ □ mark means packaging code. If you want to learn the code or quantity in detail, please see p74.

Product Lineup (Standard & High Capacitors-C0G)

| | Part Number | Size L x W (mm) | Capacitance | Rated Voltage (Vdc) | Capacitance Tolerance | Thickness Max.(mm) |
|----|------------------|--------------------|-------------|------------------------|-----------------------|--------------------|
| 30 | CL10C090DB8NNN □ | 1.60×0.80 | 9.0 pF | 50 | ±0.5pF | 0.90 |
| 31 | CL10C9R1DB8NNN □ | | 9.1 pF | 50 | ±0.5pF | 0.90 |
| 32 | CL10C100JB8NNN □ | | 10 pF | 50 | ±5% | 0.90 |
| 33 | CL10C110JB8NNN □ | | 11 pF | 50 | ±5% | 0.90 |
| 34 | CL10C120JB8NNN □ | | 12 pF | 50 | ±5% | 0.90 |
| 35 | CL10C130JB8NNN □ | | 13 pF | 50 | ±5% | 0.90 |
| 36 | CL10C140JB8NNN □ | | 14 pF | 50 | ±5% | 0.90 |
| 37 | CL10C150JB8NNN □ | | 15 pF | 50 | ±5% | 0.90 |
| 38 | CL10C160JB8NNN □ | | 16 pF | 50 | ±5% | 0.90 |
| 39 | CL10C180JB8NNN □ | | 18 pF | 50 | ±5% | 0.90 |
| 40 | CL10C200JB8NNN □ | | 20 pF | 50 | ±5% | 0.90 |
| 41 | CL10C220JB8NNN □ | | 22 pF | 50 | ±5% | 0.90 |
| 42 | CL10C240JB8NNN □ | | 24 pF | 50 | ±5% | 0.90 |
| 43 | CL10C250JB8NNN □ | | 25 pF | 50 | ±5% | 0.90 |
| 44 | CL10C270JB8NNN □ | | 27 pF | 50 | ±5% | 0.90 |
| 45 | CL10C300JB8NNN □ | | 30 pF | 50 | ±5% | 0.90 |
| 46 | CL10C330JB8NNN □ | | 33 pF | 50 | ±5% | 0.90 |
| 47 | CL10C360JB8NNN □ | | 36 pF | 50 | ±5% | 0.90 |
| 48 | CL10C390JB8NNN □ | | 39 pF | 50 | ±5% | 0.90 |
| 49 | CL10C430JB8NNN □ | | 43 pF | 50 | ±5% | 0.90 |
| 50 | CL10C470JB8NNN □ | | 47 pF | 50 | ±5% | 0.90 |
| 51 | CL10C510JB8NNN □ | | 51 pF | 50 | ±5% | 0.90 |
| 52 | CL10C560JB8NNN □ | | 56 pF | 50 | ±5% | 0.90 |
| 53 | CL10C620JB8NNN □ | | 62 pF | 50 | ±5% | 0.90 |
| 54 | CL10C680JB8NNN □ | | 68 pF | 50 | ±5% | 0.90 |
| 55 | CL10C750JB8NNN □ | | 75 pF | 50 | ±5% | 0.90 |
| 56 | CL10C820JB8NNN □ | | 82 pF | 50 | ±5% | 0.90 |
| 57 | CL10C910JB8NNN □ | | 91 pF | 50 | ±5% | 0.90 |
| 58 | CL10C101JB8NNN □ | | 100 pF | 50 | ±5% | 0.90 |
| 59 | CL10C111JB8NNN □ | | 110 pF | 50 | ±5% | 0.90 |
| 60 | CL10C121JB8NNN □ | | 120 pF | 50 | ±5% | 0.90 |
| 61 | CL10C131JB8NNN □ | | 130 pF | 50 | ±5% | 0.90 |
| 62 | CL10C151JB8NNN □ | | 150 pF | 50 | ±5% | 0.90 |
| 63 | CL10C161JB8NNN □ | | 160 pF | 50 | ±5% | 0.90 |
| 64 | CL10C181JB8NNN □ | | 180 pF | 50 | ±5% | 0.90 |
| 65 | CL10C201JB8NNN □ | | 200 pF | 50 | ±5% | 0.90 |
| 66 | CL10C221JB8NNN □ | | 220 pF | 50 | ±5% | 0.90 |
| 67 | CL10C241JB8NNN □ | | 240 pF | 50 | ±5% | 0.90 |
| 68 | CL10C271JB8NNN □ | | 270 pF | 50 | ±5% | 0.90 |
| 69 | CL10C301JB8NNN □ | | 300 pF | 50 | ±5% | 0.90 |
| 70 | CL10C331JB8NNN □ | | 330 pF | 50 | ±5% | 0.90 |
| 71 | CL10C361JB8NNN □ | | 360 pF | 50 | ±5% | 0.90 |
| 72 | CL10C391JB8NNN □ | | 390 pF | 50 | ±5% | 0.90 |
| 73 | CL10C431JB8NNN □ | | 430 pF | 50 | ±5% | 0.90 |
| 74 | CL10C471JB8NNN □ | | 470 pF | 50 | ±5% | 0.90 |
| 75 | CL10C511JB8NNN □ | | 510 pF | 50 | ±5% | 0.90 |
| 76 | CL10C561JB8NNN □ | | 560 pF | 50 | ±5% | 0.90 |
| 77 | CL10C621JB8NNN □ | | 620 pF | 50 | ±5% | 0.90 |
| 78 | CL10C681JB8NNN □ | | 680 pF | 50 | ±5% | 0.90 |
| 79 | CL10C751JB8NNN □ | | 750 pF | 50 | ±5% | 0.90 |

Part Numbering System

Standard & High Capacitors

Super Small Size Capacitors

High-Q Capacitors

Medium-High Voltage Capacitors

Array Type Capacitors

Low ESL Capacitors

Reliability Test Condition

Premium Capacitors for Automotive Applications

Packaging Specification

Application Manual for Surface Mounting

※ □ mark means packaging code. If you want to learn the code or quantity in detail, please see p74.



Product Lineup (Standard & High Capacitors-C0G)

| | Part Number | Size L x W (mm) | Capacitance | Rated Voltage (Vdc) | Capacitance Tolerance | Thickness Max.(mm) |
|----|------------------|--------------------|-------------|---------------------------|--------------------------|-----------------------|
| 80 | CL10C821JB8NNN □ | 1.60×0.80 | 820 pF | 50 | ±5% | 0.90 |
| 81 | CL10C102JB8NNN □ | | 1 nF | 50 | ±5% | 0.90 |
| 82 | CL10C182JB8NNN □ | | 1.8 nF | 50 | ±5% | 0.90 |
| 83 | CL10C222JB8NNN □ | | 2.2 nF | 50 | ±5% | 0.90 |
| 84 | CL10C562JB8NNN □ | | 5.6 nF | 50 | ±5% | 0.90 |
| 85 | CL10C103JA8NNN □ | | 10 nF | 25 | ±5% | 0.90 |
| 1 | CL21CR47CBANNN □ | 2.00×1.25 | 0.47 pF | 50 | ±0.25 pF | 0.75 |
| 2 | CL21C0R5CBANNN □ | | 0.5 pF | 50 | ±0.25 pF | 0.75 |
| 3 | CL21C010CBANNN □ | | 1.0 pF | 50 | ±0.25 pF | 0.75 |
| 4 | CL21C1R2CBANNN □ | | 1.2 pF | 50 | ±0.25 pF | 0.75 |
| 5 | CL21C1R5CBANNN □ | | 1.5 pF | 50 | ±0.25 pF | 0.75 |
| 6 | CL21C1R8CBANNN □ | | 1.8 pF | 50 | ±0.25 pF | 0.75 |
| 7 | CL21C020CBANNN □ | | 2.0 pF | 50 | ±0.25 pF | 0.75 |
| 8 | CL21C2R2CBANNN □ | | 2.2 pF | 50 | ±0.25 pF | 0.75 |
| 9 | CL21C2R4CBANNN □ | | 2.4 pF | 50 | ±0.25 pF | 0.75 |
| 10 | CL21C2R5CBANNN □ | | 2.5 pF | 50 | ±0.25 pF | 0.75 |
| 11 | CL21C2R7CBANNN □ | | 2.7 pF | 50 | ±0.25 pF | 0.75 |
| 12 | CL21C030CBANNN □ | | 3.0 pF | 50 | ±0.25 pF | 0.75 |
| 13 | CL21C3R2CBANNN □ | | 3.2 pF | 50 | ±0.25 pF | 0.75 |
| 14 | CL21C3R3CBANNN □ | | 3.3 pF | 50 | ±0.25 pF | 0.75 |
| 15 | CL21C3R6CBANNN □ | | 3.6 pF | 50 | ±0.25 pF | 0.75 |
| 16 | CL21C3R9CBANNN □ | | 3.9 pF | 50 | ±0.25 pF | 0.75 |
| 17 | CL21C040CBANNN □ | | 4.0 pF | 50 | ±0.25 pF | 0.75 |
| 18 | CL21C4R7CBANNN □ | | 4.7 pF | 50 | ±0.25 pF | 0.75 |
| 19 | CL21C5R6DBANNN □ | | 5.6 pF | 50 | ±0.5 pF | 0.75 |
| 20 | CL21C060DBANNN □ | | 6.0 pF | 50 | ±0.5 pF | 0.75 |
| 21 | CL21C6R8DBANNN □ | | 6.8 pF | 50 | ±0.5 pF | 0.75 |
| 22 | CL21C070DBANNN □ | | 7.0 pF | 50 | ±0.5 pF | 0.75 |
| 23 | CL21C7R5DBANNN □ | | 7.5 pF | 50 | ±0.5 pF | 0.75 |
| 24 | CL21C080DBANNN □ | | 8.0 pF | 50 | ±0.5 pF | 0.75 |
| 25 | CL21C8R2DBANNN □ | | 8.2 pF | 50 | ±0.5 pF | 0.75 |
| 26 | CL21C090DBANNN □ | | 9.0 pF | 50 | ±0.5 pF | 0.75 |
| 27 | CL21C100JBANNN □ | | 10 pF | 50 | ±5% | 0.75 |
| 28 | CL21C120JBANNN □ | | 12 pF | 50 | ±5% | 0.75 |
| 29 | CL21C130JBANNN □ | | 13 pF | 50 | ±5% | 0.75 |
| 30 | CL21C140JBANNN □ | | 14 pF | 50 | ±5% | 0.75 |
| 31 | CL21C150JBANNN □ | | 15 pF | 50 | ±5% | 0.75 |
| 32 | CL21C160JBANNN □ | | 16 pF | 50 | ±5% | 0.75 |
| 33 | CL21C180JBANNN □ | | 18 pF | 50 | ±5% | 0.75 |
| 34 | CL21C200JBANNN □ | | 20 pF | 50 | ±5% | 0.75 |
| 35 | CL21C220JBANNN □ | | 22 pF | 50 | ±5% | 0.75 |
| 36 | CL21C240JBANNN □ | | 24 pF | 50 | ±5% | 0.75 |
| 37 | CL21C250JBANNN □ | | 25 pF | 50 | ±5% | 0.75 |
| 38 | CL21C270JBANNN □ | | 27 pF | 50 | ±5% | 0.75 |
| 39 | CL21C300JBANNN □ | | 30 pF | 50 | ±5% | 0.75 |
| 40 | CL21C330JBANNN □ | | 33 pF | 50 | ±5% | 0.75 |
| 41 | CL21C360JBANNN □ | | 36 pF | 50 | ±5% | 0.75 |
| 42 | CL21C390JBANNN □ | | 39 pF | 50 | ±5% | 0.75 |
| 43 | CL21C430JBANNN □ | | 43 pF | 50 | ±5% | 0.75 |
| 44 | CL21C470JBANNN □ | | 47 pF | 50 | ±5% | 0.75 |
| 45 | CL21C510JBANNN □ | | 51 pF | 50 | ±5% | 0.75 |

※ □ mark means packaging code. If you want to learn the code or quantity in detail, please see p74.

Product Lineup (Standard & High Capacitors-C0G)

| | Part Number | Size L x W (mm) | Capacitance | Rated Voltage (Vdc) | Capacitance Tolerance | Thickness Max.(mm) |
|----|------------------|--------------------|-------------|------------------------|-----------------------|--------------------|
| 46 | CL21C560JBANNN □ | 2.00×1.25 | 56 pF | 50 | ±5% | 0.75 |
| 47 | CL21C620JBANNN □ | | 62 pF | 50 | ±5% | 0.75 |
| 48 | CL21C680JBANNN □ | | 68 pF | 50 | ±5% | 0.75 |
| 49 | CL21C750JBANNN □ | | 75 pF | 50 | ±5% | 0.75 |
| 50 | CL21C820JBANNN □ | | 82 pF | 50 | ±5% | 0.75 |
| 51 | CL21C910JBANNN □ | | 91 pF | 50 | ±5% | 0.75 |
| 52 | CL21C101JBANNN □ | | 100 pF | 50 | ±5% | 0.75 |
| 53 | CL21C111JBANNN □ | | 110 pF | 50 | ±5% | 0.75 |
| 54 | CL21C121JBANNN □ | | 120 pF | 50 | ±5% | 0.75 |
| 55 | CL21C131JBANNN □ | | 130 pF | 50 | ±5% | 0.75 |
| 56 | CL21C151JBANNN □ | | 150 pF | 50 | ±5% | 0.75 |
| 57 | CL21C161JBANNN □ | | 160 pF | 50 | ±5% | 0.75 |
| 58 | CL21C181JBANNN □ | | 180 pF | 50 | ±5% | 0.75 |
| 59 | CL21C201JBANNN □ | | 200 pF | 50 | ±5% | 0.75 |
| 60 | CL21C221JBANNN □ | | 220 pF | 50 | ±5% | 0.75 |
| 61 | CL21C241JBANNN □ | | 240 pF | 50 | ±5% | 0.75 |
| 62 | CL21C271JBANNN □ | | 270 pF | 50 | ±5% | 0.75 |
| 63 | CL21C301JBANNN □ | | 300 pF | 50 | ±5% | 0.75 |
| 64 | CL21C331JBANNN □ | | 330 pF | 50 | ±5% | 0.75 |
| 65 | CL21C361JBANNN □ | | 360 pF | 50 | ±5% | 0.75 |
| 66 | CL21C391JBANNN □ | | 390 pF | 50 | ±5% | 0.75 |
| 67 | CL21C431JBANNN □ | | 430 pF | 50 | ±5% | 0.75 |
| 68 | CL21C471JBANNN □ | | 470 pF | 50 | ±5% | 0.75 |
| 69 | CL21C511JBANNN □ | | 510 pF | 50 | ±5% | 0.75 |
| 70 | CL21C561JBANNN □ | | 560 pF | 50 | ±5% | 0.75 |
| 71 | CL21C621JBCNNN □ | | 620 pF | 50 | ±5% | 0.95 |
| 72 | CL21C681JBCNNN □ | | 680 pF | 50 | ±5% | 0.95 |
| 73 | CL21C751JBCNNN □ | | 750 pF | 50 | ±5% | 0.95 |
| 74 | CL21C821JBCNNN □ | | 820 pF | 50 | ±5% | 0.95 |
| 75 | CL21C102JBCNNN □ | | 1 nF | 50 | ±5% | 0.95 |
| 76 | CL21C122JBFNNN □ | | 1.2 nF | 50 | ±5% | 1.35 |
| 77 | CL21C152JBFNNN □ | | 1.5 nF | 50 | ±5% | 1.35 |
| 78 | CL21C182JBFNNN □ | | 1.8 nF | 50 | ±5% | 1.35 |
| 79 | CL21C222JBFNNN □ | | 2.2 nF | 50 | ±5% | 1.35 |
| 80 | CL21C332JAFNNN □ | | 3.3 nF | 25 | ±5% | 1.35 |
| 81 | CL21C332JBFNNN □ | | 3.3 nF | 50 | ±5% | 1.35 |
| 82 | CL21C392JAANNN □ | | 3.9 nF | 25 | ±5% | 0.75 |
| 83 | CL21C392JBFNNN □ | | 3.9 nF | 50 | ±5% | 1.35 |
| 84 | CL21C472JBFNNN □ | 4.7 nF | 50 | ±5% | 1.35 | |
| 85 | CL21C562JBFNNN □ | 5.6 nF | 50 | ±5% | 1.35 | |
| 86 | CL21C822JAFNNN □ | 8.2 nF | 25 | ±5% | 1.35 | |
| 87 | CL21C103JBFNNN □ | 10 nF | 50 | ±5% | 1.35 | |
| 88 | CL21C333JAFNNN □ | 33 nF | 25 | ±5% | 1.35 | |
| 1 | CL31C0R5CBCNNN □ | 3.20×1.60 | 0.5 pF | 50 | ±0.25 pF | 1.00 |
| 2 | CL31C010CBCNNN □ | | 1.0 pF | 50 | ±0.25 pF | 1.00 |
| 3 | CL31C1R5CBCNNN □ | | 1.5 pF | 50 | ±0.25 pF | 1.00 |
| 4 | CL31C1R8CBCNNN □ | | 1.8 pF | 50 | ±0.25 pF | 1.00 |
| 5 | CL31C020CBCNNN □ | | 2.0 pF | 50 | ±0.25 pF | 1.00 |
| 6 | CL31C2R2CBCNNN □ | | 2.2 pF | 50 | ±0.25 pF | 1.00 |
| 7 | CL31C2R7CBCNNN □ | | 2.7 pF | 50 | ±0.25 pF | 1.00 |

※ □ mark means packaging code. If you want to learn the code or quantity in detail, please see p74.

Part Numbering System

Standard & High Capacitors

Super Small Size Capacitors

High-Q Capacitors

Medium-High Voltage Capacitors

Array Type Capacitors

Low ESL Capacitors

Reliability Test Condition

Premium Capacitors for Automotive Applications

Packaging Specification

Application Manual for Surface Mounting



Product Lineup (Standard & High Capacitors-C0G)

| | Part Number | Size L x W (mm) | Capacitance | Rated Voltage (Vdc) | Capacitance Tolerance | Thickness Max.(mm) | |
|----|------------------|--------------------|-------------|------------------------|-----------------------|--------------------|------|
| 8 | CL31C030CBCNNN □ | 3.20×1.60 | 3.0 pF | 50 | ±0.25 pF | 1.00 | |
| 9 | CL31C3R3CBCNNN □ | | 3.3 pF | 50 | ±0.25 pF | 1.00 | |
| 10 | CL31C040CBCNNN □ | | 4.0 pF | 50 | ±0.25 pF | 1.00 | |
| 11 | CL31C4R7CBCNNN □ | | 4.7 pF | 50 | ±0.25 pF | 1.00 | |
| 12 | CL31C100JBCNNN □ | | 10 pF | 50 | ±5% | 1.00 | |
| 13 | CL31C120JBCNNN □ | | 12 pF | 50 | ±5% | 1.00 | |
| 14 | CL31C150JBCNNN □ | | 15 pF | 50 | ±5% | 1.00 | |
| 15 | CL31C180JBCNNN □ | | 18 pF | 50 | ±5% | 1.00 | |
| 16 | CL31C200JBCNNN □ | | 20 pF | 50 | ±5% | 1.00 | |
| 17 | CL31C220JBCNNN □ | | 22 pF | 50 | ±5% | 1.00 | |
| 18 | CL31C270JBCNNN □ | | 27 pF | 50 | ±5% | 1.00 | |
| 19 | CL31C300JBCNNN □ | | 30 pF | 50 | ±5% | 1.00 | |
| 20 | CL31C330JBCNNN □ | | 33 pF | 50 | ±5% | 1.00 | |
| 21 | CL31C390JBCNNN □ | | 39 pF | 50 | ±5% | 1.00 | |
| 22 | CL31C470JBCNNN □ | | 47 pF | 50 | ±5% | 1.00 | |
| 23 | CL31C510JBCNNN □ | | 51 pF | 50 | ±5% | 1.00 | |
| 24 | CL31C560JBCNNN □ | | 56 pF | 50 | ±5% | 1.00 | |
| 25 | CL31C680JBCNNN □ | | 68 pF | 50 | ±5% | 1.00 | |
| 26 | CL31C750JBCNNN □ | | 75 pF | 50 | ±5% | 1.00 | |
| 27 | CL31C820JBCNNN □ | | 82 pF | 50 | ±5% | 1.00 | |
| 28 | CL31C101JBCNNN □ | | 100 pF | 50 | ±5% | 1.00 | |
| 29 | CL31C121JBCNNN □ | | 120 pF | 50 | ±5% | 1.00 | |
| 30 | CL31C151JBCNNN □ | | 150 pF | 50 | ±5% | 1.00 | |
| 31 | CL31C181JBCNNN □ | | 180 pF | 50 | ±5% | 1.00 | |
| 32 | CL31C221JBCNNN □ | | 220 pF | 50 | ±5% | 1.00 | |
| 33 | CL31C271JBCNNN □ | | 270 pF | 50 | ±5% | 1.00 | |
| 34 | CL31C331JBCNNN □ | | 330 pF | 50 | ±5% | 1.00 | |
| 35 | CL31C391JBCNNN □ | | 390 pF | 50 | ±5% | 1.00 | |
| 36 | CL31C471JBCNNN □ | | 470 pF | 50 | ±5% | 1.00 | |
| 37 | CL31C561JBCNNN □ | | 560 pF | 50 | ±5% | 1.00 | |
| 38 | CL31C681JBCNNN □ | | 680 pF | 50 | ±5% | 1.00 | |
| 39 | CL31C821JBCNNN □ | | 820 pF | 50 | ±5% | 1.00 | |
| 40 | CL31C102JBCNNN □ | | 1 nF | 50 | ±5% | 1.00 | |
| 41 | CL31C122JBCNNN □ | | 1.2 nF | 50 | ±5% | 1.00 | |
| 42 | CL31C152JBCNNN □ | | 1.5 nF | 50 | ±5% | 1.00 | |
| 43 | CL31C182JBCNNN □ | | 1.8 nF | 50 | ±5% | 1.00 | |
| 44 | CL31C222JBCNNN □ | | 2.2 nF | 50 | ±5% | 1.00 | |
| 45 | CL31C272JBFNNN □ | | 2.7 nF | 50 | ±5% | 1.40 | |
| 46 | CL31C332JBFNNN □ | | 3.3 nF | 50 | ±5% | 1.40 | |
| 47 | CL31C472JBFNNN □ | | 4.7 nF | 50 | ±5% | 1.40 | |
| 48 | CL31C682JBHNNN □ | | 6.8 nF | 50 | ±5% | 1.80 | |
| 49 | CL31C103JAFNNN □ | | 10 nF | 25 | ±5% | 1.40 | |
| 50 | CL31C223JBHNNN □ | | 22 nF | 50 | ±5% | 1.80 | |
| 51 | CL31C333JBHNNN □ | | 33 nF | 50 | ±5% | 1.80 | |
| 52 | CL31C473JBHNNN □ | | 47 nF | 50 | ±5% | 1.80 | |
| 53 | CL31C683JAHNNN □ | | 68 nF | 25 | ±5% | 1.80 | |
| 54 | CL31C104JAHNNN □ | | 100 nF | 25 | ±5% | 1.80 | |
| 1 | CL32C472JBFNNN □ | | 3.20×2.50 | 4.7 nF | 50 | ±5% | 1.45 |
| 2 | CL32C103JBFNNN □ | | | 10 nF | 50 | ±5% | 1.45 |
| 3 | CL32C223JBHNNN □ | | | 22 nF | 50 | ±5% | 1.80 |
| 4 | CL32C333JBHNNN □ | | | 33 nF | 50 | ±5% | 1.80 |
| 5 | CL32C473JBHNNN □ | | | 47 nF | 50 | ±5% | 1.80 |

※ □ mark means packaging code. If you want to learn the code or quantity in detail, please see p74.

Product Lineup (Standard & High Capacitors-X5R)

| | Part Number | Size L x W (mm) | Capacitance | Rated Voltage (Vdc) | Capacitance Tolerance | Thickness Max.(mm) |
|----|-----------------|--------------------|-------------|------------------------|-----------------------|--------------------|
| 1 | CL05A223KO5NNN□ | 1.00×0.50 | 22 nF | 16 | ±10% | 0.55 |
| 2 | CL05A104KA5NNN□ | | 0.1 μF | 25 | ±10% | 0.55 |
| 3 | CL05A104KO5NNN□ | | 0.1 μF | 16 | ±10% | 0.55 |
| 4 | CL05A104KP5NNN□ | | 0.1 μF | 10 | ±10% | 0.55 |
| 5 | CL05A224KA5NNN□ | | 0.22 μF | 25 | ±10% | 0.55 |
| 6 | CL05A224KP5NNN□ | | 0.22 μF | 10 | ±10% | 0.55 |
| 7 | CL05A334KA5NNN□ | | 0.33 μF | 25 | ±10% | 0.55 |
| 8 | CL05A334KP5NNN□ | | 0.33 μF | 10 | ±10% | 0.55 |
| 9 | CL05A474KA5NNN□ | | 0.47 μF | 25 | ±10% | 0.55 |
| 10 | CL05A474KO5NNN□ | | 0.47 μF | 16 | ±10% | 0.55 |
| 11 | CL05A474KP5NNN□ | | 0.47 μF | 10 | ±10% | 0.55 |
| 12 | CL05A474KQ5NNN□ | | 0.47 μF | 6.3 | ±10% | 0.55 |
| 13 | CL05A474KR5NNN□ | | 0.47 μF | 4 | ±10% | 0.55 |
| 14 | CL05A105KA5NQN□ | | 1 μF | 25 | ±10% | 0.60 |
| 15 | CL05A105KO5NNN□ | | 1 μF | 16 | ±10% | 0.55 |
| 16 | CL05A105KO3LQN□ | | 1 μF | 16 | ±10% | 0.33 |
| 17 | CL05A105KP5NNN□ | | 1 μF | 10 | ±10% | 0.55 |
| 18 | CL05A105KP3LNN□ | | 1 μF | 10 | ±10% | 0.33 |
| 19 | CL05A105KQ5NNN□ | | 1 μF | 6.3 | ±10% | 0.55 |
| 20 | CL05A105KQ3LNN□ | | 1 μF | 6.3 | ±10% | 0.33 |
| 21 | CL05A105KR5NNN□ | | 1 μF | 4 | ±10% | 0.55 |
| 22 | CL05A105KR3LNN□ | | 1 μF | 4 | ±10% | 0.33 |
| 23 | CL05A225MA5NUN□ | | 2.2 μF | 25 | ±20% | 0.70 |
| 24 | CL05A225KO5NQN□ | | 2.2 μF | 16 | ±10% | 0.60 |
| 25 | CL05A225MP5NSN□ | | 2.2 μF | 10 | ±20% | 0.57 |
| 26 | CL05A225KP3LRN□ | | 2.2 μF | 10 | ±10% | 0.33 |
| 27 | CL05A225MQ5NNN□ | | 2.2 μF | 6.3 | ±20% | 0.55 |
| 28 | CL05A225KQ3LRN□ | | 2.2 μF | 6.3 | ±10% | 0.33 |
| 29 | CL05A225MR5NNN□ | | 2.2 μF | 4 | ±20% | 0.55 |
| 30 | CL05A225KR3LRN□ | | 2.2 μF | 4 | ±10% | 0.33 |
| 31 | CL05A475MO5NUN□ | | 4.7 μF | 16 | ±20% | 0.70 |
| 32 | CL05A475MP5NRN□ | | 4.7 μF | 10 | ±20% | 0.65 |
| 33 | CL05A475MQ5NRN□ | | 4.7 μF | 6.3 | ±20% | 0.65 |
| 34 | CL05A475MQ3LUN□ | | 4.7 μF | 6.3 | ±20% | 0.35 |
| 35 | CL05A106MP5NUN□ | | 10 μF | 10 | ±20% | 0.70 |
| 36 | CL05A106MQ5NUN□ | | 10 μF | 6.3 | ±20% | 0.70 |
| 37 | CL05A106MR5NRN□ | | 10 μF | 4 | ±20% | 0.65 |
| 38 | CL05A156MR5NUN□ | | 15 μF | 4 | ±20% | 0.70 |
| 39 | CL05A226MR5NZN□ | | 22 μF | 4 | ±20% | 0.90 |
| 1 | CL10A474KB8NNN□ | 1.60×0.80 | 0.47 μF | 50 | ±10% | 0.90 |
| 2 | CL10A474KA8NNN□ | | 0.47 μF | 25 | ±10% | 0.90 |
| 3 | CL10A474KP8NNN□ | | 0.47 μF | 10 | ±10% | 0.90 |
| 4 | CL10A474KQ8NNN□ | | 0.47 μF | 6.3 | ±10% | 0.90 |
| 5 | CL10A474KR8NNN□ | | 0.47 μF | 4 | ±10% | 0.90 |
| 6 | CL10A105KB8NNN□ | | 1 μF | 50 | ±10% | 0.90 |
| 7 | CL10A105KA5LNN□ | | 1 μF | 25 | ±10% | 0.50 |
| 8 | CL10A105KA8NNN□ | | 1 μF | 25 | ±10% | 0.90 |
| 9 | CL10A105KO8NNN□ | | 1 μF | 16 | ±10% | 0.90 |
| 10 | CL10A105KO5LNN□ | | 1 μF | 16 | ±10% | 0.50 |
| 11 | CL10A105KP8NNN□ | | 1 μF | 10 | ±10% | 0.90 |
| 12 | CL10A105KP5LNN□ | | 1 μF | 10 | ±10% | 0.50 |
| 13 | CL10A105KQ8NNN□ | | 1 μF | 6.3 | ±10% | 0.90 |
| 14 | CL10A105KQ5LNN□ | | 1 μF | 6.3 | ±10% | 0.50 |

Part Numbering System

Standard & High Capacitors

Super Small Size Capacitors

High-Q Capacitors

Medium-High Voltage Capacitors

Array Type Capacitors

Low ESL Capacitors

Reliability Test Condition

Premium Capacitors for Automotive Applications

Packaging Specification

Application Manual for Surface Mounting

※ □ mark means packaging code. If you want to learn the code or quantity in detail, please see p74.



Product Lineup (Standard & High Capacitors-X5R)

| | Part Number | Size L x W (mm) | Capacitance | Rated Voltage (Vdc) | Capacitance Tolerance | Thickness Max.(mm) |
|----|-------------------|--------------------|-------------|---------------------------|--------------------------|-----------------------|
| 15 | CL10A105KR8NNN □ | 1.60×0.80 | 1 μF | 4 | ±10% | 0.90 |
| 16 | CL10A105KR5LNN □ | | 1 μF | 4 | ±10% | 0.50 |
| 17 | CL10A105KA5LNN □ | | 1 μF | 25 | ±10% | 0.50 |
| 18 | CL10A225KA8NNN □ | | 2.2 μF | 25 | ±10% | 0.90 |
| 19 | CL10A225KA5LNN □ | | 2.2 μF | 25 | ±10% | 0.50 |
| 20 | CL10A225KO8NNN □ | | 2.2 μF | 16 | ±10% | 0.90 |
| 21 | CL10A225KO5LNN □ | | 2.2 μF | 16 | ±10% | 0.50 |
| 22 | CL10A225KP8NNN □ | | 2.2 μF | 10 | ±10% | 0.90 |
| 23 | CL10A225KP5LNN □ | | 2.2 μF | 10 | ±10% | 0.50 |
| 24 | CL10A225KQ8NNN □ | | 2.2 μF | 6.3 | ±10% | 0.90 |
| 25 | CL10A225KQ5LNN □ | | 2.2 μF | 6.3 | ±10% | 0.50 |
| 26 | CL10A225KR8NNN □ | | 2.2 μF | 4 | ±10% | 0.90 |
| 27 | CL10A225KR5LNN □ | | 2.2 μF | 4 | ±10% | 0.50 |
| 28 | CL10A335KQ8NNN □ | | 3.3 μF | 6.3 | ±10% | 0.90 |
| 29 | CL10A335KR8NNN □ | | 3.3 μF | 4 | ±10% | 0.90 |
| 30 | CL10A475KA8NQN □ | | 4.7 μF | 25 | ±10% | 0.95 |
| 31 | CL10A475KO8NNN □ | | 4.7 μF | 16 | ±10% | 0.90 |
| 32 | CL10A475KP8NNN □ | | 4.7 μF | 10 | ±10% | 0.90 |
| 33 | CL10A475KP5LNN □ | | 4.7 μF | 10 | ±10% | 0.50 |
| 34 | CL10A475KQ5LNN □ | | 4.7 μF | 6.3 | ±10% | 0.50 |
| 35 | CL10A475KQ8NNN □ | | 4.7 μF | 6.3 | ±10% | 0.90 |
| 36 | CL10A475KR5LNN □ | | 4.7 μF | 4 | ±10% | 0.50 |
| 37 | CL10A475KR8NNN □ | | 4.7 μF | 4 | ±10% | 0.90 |
| 38 | CL10A106KR8NNN □ | | 10 μF | 4 | ±10% | 0.90 |
| 39 | CL10A106MR5LRN □ | | 10 μF | 4 | ±20% | 0.50 |
| 40 | CL10A106KQ8NNN □ | | 10 μF | 6.3 | ±10% | 0.90 |
| 41 | CL10A106MQ5LRN □ | | 10 μF | 6.3 | ±20% | 0.50 |
| 42 | CL10A106MP8NNN □ | | 10 μF | 10 | ±20% | 0.90 |
| 43 | CL10A106MO8NQN □ | | 10 μF | 16 | ±20% | 0.95 |
| 44 | CL10A106MA8NRRN □ | | 10 μF | 25 | ±20% | 1.00 |
| 45 | CL10A226MR8NRRN □ | | 22 μF | 4 | ±20% | 1.00 |
| 46 | CL10A226MQ8NRRN □ | | 22 μF | 6.3 | ±20% | 1.00 |
| 47 | CL10A226MP8NRRN □ | | 22 μF | 10 | ±20% | 1.00 |
| 48 | CL10A226MP8NUN □ | | 22 μF | 10 | ±20% | 1.05 |
| 49 | CL10A476MR8NZN □ | | 47 μF | 4 | ±20% | 1.10 |
| 50 | CL10A476MQ8CZN □ | 47 μF | 6.3 | ±20% | 1.10 | |
| 1 | CL21A105KBQNNN □ | 2.00×1.25 | 1 μF | 50 | ±10% | 1.40 |
| 2 | CL21A105KAFNNN □ | | 1 μF | 25 | ±10% | 1.35 |
| 3 | CL21A105KA6LNN □ | | 1 μF | 25 | ±10% | 0.70 |
| 4 | CL21A105KOFNNN □ | | 1 μF | 16 | ±10% | 1.35 |
| 5 | CL21A105KO6LNN □ | | 1 μF | 16 | ±10% | 0.70 |
| 6 | CL21A105KQFNNN □ | | 1 μF | 6.3 | ±10% | 1.35 |
| 7 | CL21A105KRFNNN □ | | 1 μF | 4 | ±10% | 1.35 |
| 8 | CL21A225KBQNNN □ | | 2.2 μF | 50 | ±10% | 1.40 |
| 9 | CL21A225KAFNNN □ | | 2.2 μF | 25 | ±10% | 1.35 |
| 10 | CL21A225KO6LNN □ | | 2.2 μF | 16 | ±10% | 0.70 |
| 11 | CL21A225KOFNNN □ | | 2.2 μF | 16 | ±10% | 1.35 |
| 12 | CL21A225KPFNNN □ | | 2.2 μF | 10 | ±10% | 1.35 |
| 13 | CL21A225KQFNNN □ | | 2.2 μF | 6.3 | ±10% | 1.35 |
| 14 | CL21A225KRFNNN □ | | 2.2 μF | 4 | ±10% | 1.35 |
| 15 | CL21A475KBQNNN □ | | 4.7 μF | 50 | ±10% | 1.40 |

※ □ mark means packaging code. If you want to learn the code or quantity in detail, please see p74.

Product Lineup (Standard & High Capacitors-X5R)

| | Part Number | Size L x W (mm) | Capacitance | Rated Voltage (Vdc) | Capacitance Tolerance | Thickness Max.(mm) |
|----|------------------|--------------------|-------------|------------------------|-----------------------|--------------------|
| 16 | CL21A475KAQNNN□ | 2.00×1.25 | 4.7 μ F | 25 | ±10% | 1.40 |
| 17 | CL21A475KACL RN□ | | 4.7 μ F | 25 | ±10% | 0.95 |
| 18 | CL21A475KOFNNN□ | | 4.7 μ F | 16 | ±10% | 1.35 |
| 19 | CL21A475KOCLNN□ | | 4.7 μ F | 16 | ±10% | 0.95 |
| 20 | CL21A475KPFNNN□ | | 4.7 μ F | 10 | ±10% | 1.35 |
| 21 | CL21A475KPCLNN□ | | 4.7 μ F | 10 | ±10% | 0.95 |
| 22 | CL21A475KQFNNN□ | | 4.7 μ F | 6.3 | ±10% | 1.35 |
| 23 | CL21A475KQCLNN□ | | 4.7 μ F | 6.3 | ±10% | 0.95 |
| 24 | CL21A475KRFNNN□ | | 4.7 μ F | 4 | ±10% | 1.35 |
| 25 | CL21A475KRCLNN□ | | 4.7 μ F | 4 | ±10% | 0.95 |
| 26 | CL21A106KAYNNN□ | | 10 μ F | 25 | ±10% | 1.45 |
| 27 | CL21A106KACL RN□ | | 10 μ F | 25 | ±10% | 0.95 |
| 28 | CL21A106KA7LQN□ | | 10 μ F | 25 | ±10% | 0.80 |
| 29 | CL21A106KOFNNN□ | | 10 μ F | 16 | ±10% | 1.35 |
| 30 | CL21A106KQNNN□ | | 10 μ F | 16 | ±10% | 1.40 |
| 31 | CL21A106KOCL RN□ | | 10 μ F | 16 | ±10% | 0.95 |
| 32 | CL21A106KOCL3R□ | | 10 μ F | 16 | ±10% | 0.95 |
| 33 | CL21A106KPFNNN□ | | 10 μ F | 10 | ±10% | 1.35 |
| 34 | CL21A106KPCLQN□ | | 10 μ F | 10 | ±10% | 0.95 |
| 35 | CL21A106KQFNNN□ | | 10 μ F | 6.3 | ±10% | 1.35 |
| 36 | CL21A106KQCLNN□ | | 10 μ F | 6.3 | ±10% | 0.95 |
| 37 | CL21A106KRFNNN□ | | 10 μ F | 4 | ±10% | 1.35 |
| 38 | CL21A106KRCLNN□ | | 10 μ F | 4 | ±10% | 0.95 |
| 39 | CL21A226MAQNNN□ | | 22 μ F | 25 | ±20% | 1.40 |
| 40 | CL21A226MPQNNN□ | | 22 μ F | 10 | ±20% | 1.40 |
| 41 | CL21A226MPCL RN□ | | 22 μ F | 10 | ±20% | 0.95 |
| 42 | CL21A226MQNNN□ | | 22 μ F | 6.3 | ±20% | 1.40 |
| 43 | CL21A226MQCL RN□ | | 22 μ F | 6.3 | ±20% | 0.95 |
| 44 | CL21A226MRQNNN□ | | 22 μ F | 4 | ±20% | 1.40 |
| 45 | CL21A226MRCL RN□ | | 22 μ F | 4 | ±20% | 0.95 |
| 46 | CL21A336MQELNN□ | | 33 μ F | 6.3 | ±20% | 1.20 |
| 47 | CL21A336MQ9LNN□ | | 33 μ F | 6.3 | ±20% | 1.00 |
| 48 | CL21A336MRELNN□ | 33 μ F | 4 | ±20% | 1.20 | |
| 49 | CL21A336MR9LNN□ | 33 μ F | 4 | ±20% | 1.00 | |
| 50 | CL21A476MQYNNN□ | 47 μ F | 6.3 | ±20% | 1.45 | |
| 51 | CL21A476MRYNNN□ | 47 μ F | 4 | ±20% | 1.45 | |
| 52 | CL21A476MQ9L RN□ | 47 μ F | 6.3 | ±20% | 1.00 | |
| 1 | CL31A225KC9LNN□ | 3.20×1.60 | 2.2 μ F | 100 | ±10% | 1.00 |
| 2 | CL31A475KBHNNN□ | | 4.7 μ F | 50 | ±10% | 1.80 |
| 3 | CL31A475KB9LNN□ | | 4.7 μ F | 50 | ±10% | 1.00 |
| 4 | CL31A475KAHNNN□ | | 4.7 μ F | 25 | ±10% | 1.80 |
| 5 | CL31A475KACL NN□ | | 4.7 μ F | 25 | ±10% | 0.95 |
| 6 | CL31A475KOHNNN□ | | 4.7 μ F | 16 | ±10% | 1.80 |
| 7 | CL31A475KOCL NN□ | | 4.7 μ F | 16 | ±10% | 0.95 |
| 8 | CL31A475KPHNNN□ | | 4.7 μ F | 10 | ±10% | 1.80 |
| 9 | CL31A475KQHNNN□ | | 4.7 μ F | 6.3 | ±10% | 1.80 |
| 10 | CL31A475KRHNNN□ | | 4.7 μ F | 4 | ±10% | 1.80 |
| 11 | CL31A106KBHNNN□ | | 10 μ F | 50 | ±10% | 1.80 |
| 12 | CL31A106KAHNNN□ | | 10 μ F | 25 | ±10% | 1.80 |
| 13 | CL31A106KACL NN□ | | 10 μ F | 25 | ±10% | 0.95 |
| 14 | CL31A106KOHNNN□ | | 10 μ F | 16 | ±10% | 1.80 |

※ □ mark means packaging code. If you want to learn the code or quantity in detail, please see p74.

Part Numbering System

Standard & High Capacitors

Super Small Size Capacitors

High-Q Capacitors

Medium-High Voltage Capacitors

Array Type Capacitors

Low ESL Capacitors

Reliability Test Condition

Premium Capacitors for Automotive Applications

Packaging Specification

Application Manual for Surface Mounting



Product Lineup (Standard & High Capacitors-X5R)

| | Part Number | Size L x W (mm) | Capacitance | Rated Voltage (Vdc) | Capacitance Tolerance | Thickness Max.(mm) |
|----|------------------|--------------------|-------------|------------------------|-----------------------|--------------------|
| 15 | CL31A106KOCLNN □ | 3.20×1.60 | 10 μ F | 16 | ±10% | 0.95 |
| 16 | CL31A106KPHNNN □ | | 10 μ F | 10 | ±10% | 1.80 |
| 17 | CL31A106KPCLNN □ | | 10 μ F | 10 | ±10% | 0.95 |
| 18 | CL31A106KQHNNN □ | | 10 μ F | 6.3 | ±10% | 1.80 |
| 19 | CL31A106KRHNNN □ | | 10 μ F | 4 | ±10% | 1.80 |
| 20 | CL31A156KQHNNN □ | | 15 μ F | 6.3 | ±10% | 1.80 |
| 21 | CL31A156KRHNNN □ | | 15 μ F | 4 | ±10% | 1.80 |
| 22 | CL31A226KAHNNN □ | | 22 μ F | 25 | ±10% | 1.80 |
| 23 | CL31A226KOHNNN □ | | 22 μ F | 16 | ±10% | 1.80 |
| 24 | CL31A226KOCLNN □ | | 22 μ F | 16 | ±10% | 0.95 |
| 25 | CL31A226KPHNNN □ | | 22 μ F | 10 | ±10% | 1.80 |
| 26 | CL31A226KPCLNN □ | | 22 μ F | 10 | ±10% | 0.95 |
| 27 | CL31A226KQHNNN □ | | 22 μ F | 6.3 | ±10% | 1.80 |
| 28 | CL31A476KPHNNN □ | | 47 μ F | 10 | ±10% | 1.80 |
| 29 | CL31A476MQHNNN □ | | 47 μ F | 6.3 | ±20% | 1.80 |
| 30 | CL31A476MRHNNN □ | | 47 μ F | 4 | ±20% | 1.80 |
| 31 | CL31A107MQHNNN □ | | 100 μ F | 6.3 | ±20% | 1.80 |
| 32 | CL31A107MRHNNN □ | | 100 μ F | 4 | ±20% | 1.80 |
| 33 | CL31A107MPHNNN □ | | 100 μ F | 10 | ±20% | 1.80 |
| 1 | CL32A106KQCLNN □ | | 3.20×2.50 | 10 μ F | 6.3 | ±10% |
| 2 | CL32A106KRCLNN □ | 10 μ F | | 4 | ±10% | 0.95 |
| 3 | CL32A106KBULNN □ | 10 μ F | | 50 | ±10% | 2.00 |
| 4 | CL32A106KAJNNN □ | 10 μ F | | 25 | ±10% | 2.70 |
| 5 | CL32A106KAULNN □ | 10 μ F | | 25 | ±10% | 2.00 |
| 6 | CL32A106KOJNNN □ | 10 μ F | | 16 | ±10% | 2.70 |
| 7 | CL32A106KPJNNN □ | 10 μ F | | 10 | ±10% | 2.70 |
| 8 | CL32A226KAJNNN □ | 22 μ F | | 25 | ±10% | 2.70 |
| 9 | CL32A226KOJNNN □ | 22 μ F | | 16 | ±10% | 2.70 |
| 10 | CL32A226KOCLNN □ | 22 μ F | | 16 | ±10% | 0.95 |
| 11 | CL32A226KPJNNN □ | 22 μ F | | 10 | ±10% | 2.70 |
| 12 | CL32A226KQJNNN □ | 22 μ F | | 6.3 | ±10% | 2.70 |
| 13 | CL32A226MQCLNN □ | 22 μ F | | 6.3 | ±20% | 0.95 |
| 14 | CL32A226KRJNNN □ | 22 μ F | | 4 | ±10% | 2.70 |
| 15 | CL32A226MRCLNN □ | 22 μ F | | 4 | ±20% | 0.95 |
| 16 | CL32A476KOJNNN □ | 47 μ F | | 16 | ±10% | 2.70 |
| 17 | CL32A476KPJNNN □ | 47 μ F | | 10 | ±10% | 2.70 |
| 18 | CL32A476MQJNNN □ | 47 μ F | | 6.3 | ±20% | 2.70 |
| 19 | CL32A476MRJNNN □ | 47 μ F | | 4 | ±20% | 2.70 |
| 20 | CL32A107MPVNNN □ | 100 μ F | | 10 | ±20% | 2.80 |
| 21 | CL32A107MQVNNN □ | 100 μ F | | 6.3 | ±20% | 2.80 |
| 22 | CL32A107MRVNNN □ | 100 μ F | | 4 | ±20% | 2.80 |
| 23 | CL32A157MQVNNN □ | 150 μ F | | 6.3 | ±20% | 2.80 |
| 24 | CL32A227MQVNNN □ | 220 μ F | | 6.3 | ±20% | 2.80 |
| 1 | CL43A476MQJNNN □ | 4.50×3.20 | 47 μ F | 6.3 | ±20% | 2.70 |
| 2 | CL43A476MRJNNN □ | | 47 μ F | 4 | ±20% | 2.70 |
| 3 | CL43A107KQLNNN □ | | 100 μ F | 6.3 | ±10% | 3.50 |
| 4 | CL43A107KRLNNN □ | | 100 μ F | 4 | ±10% | 3.50 |

※ □ mark means packaging code. If you want to learn the code or quantity in detail, please see p74.

Product Lineup (Standard & High Capacitors-X6S)

| | Part Number | Size L x W (mm) | Capacitance | Rated Voltage (Vdc) | Capacitance Tolerance | Thickness Max.(mm) |
|----|------------------|--------------------|-------------|------------------------|-----------------------|--------------------|
| 1 | CL05X224KP5NNN □ | 1.00×0.50 | 0.22 μF | 10 | ±10% | 0.55 |
| 2 | CL05X224KQ5NNN □ | | 0.22 μF | 6.3 | ±10% | 0.55 |
| 3 | CL05X474KP5NNN □ | | 0.47 μF | 10 | ±10% | 0.55 |
| 4 | CL05X474KQ5NNN □ | | 0.47 μF | 6.3 | ±10% | 0.55 |
| 5 | CL05X474MR5NNN □ | | 0.47 μF | 4 | ±20% | 0.55 |
| 6 | CL05X684JQ5NNN □ | | 0.68 μF | 6.3 | ±5% | 0.55 |
| 7 | CL05X105KA5NQN □ | | 1 μF | 25 | ±10% | 0.60 |
| 8 | CL05X105KP5NNN □ | | 1 μF | 10 | ±10% | 0.55 |
| 9 | CL05X105MQ3LNN □ | | 1 μF | 6.3 | ±20% | 0.33 |
| 10 | CL05X225MP5NUN □ | | 2.2 μF | 10 | ±20% | 0.70 |
| 11 | CL05X475MQ5NUN □ | | 4.7 μF | 6.3 | ±20% | 0.70 |
| 12 | CL05X106MR5NUN □ | | 10 μF | 4 | ±20% | 0.70 |
| 1 | CL10X474KA8NNN □ | 1.60×0.80 | 0.47 μF | 25 | ±10% | 0.90 |
| 2 | CL10X474KO8NNN □ | | 0.47 μF | 16 | ±10% | 0.90 |
| 3 | CL10X474KP8NNN □ | | 0.47 μF | 10 | ±10% | 0.90 |
| 4 | CL10X474KQ8NNN □ | | 0.47 μF | 6.3 | ±10% | 0.90 |
| 5 | CL10X474KR8NNN □ | | 0.47 μF | 4 | ±10% | 0.90 |
| 6 | CL10X105KA8NNN □ | | 1 μF | 25 | ±10% | 0.90 |
| 7 | CL10X105KO8NNN □ | | 1 μF | 16 | ±10% | 0.90 |
| 8 | CL10X105KP8NNN □ | | 1 μF | 10 | ±10% | 0.90 |
| 9 | CL10X105KQ8NNN □ | | 1 μF | 6.3 | ±10% | 0.90 |
| 10 | CL10X105KR8NNN □ | | 1 μF | 4 | ±10% | 0.90 |
| 11 | CL10X225KO8NNN □ | | 2.2 μF | 16 | ±10% | 0.90 |
| 12 | CL10X225KP8NNN □ | | 2.2 μF | 10 | ±10% | 0.90 |
| 13 | CL10X225KQ8NNN □ | | 2.2 μF | 6.3 | ±10% | 0.90 |
| 14 | CL10X225KR8NNN □ | | 2.2 μF | 4 | ±10% | 0.90 |
| 15 | CL10X475KA8NQN □ | | 4.7 μF | 25 | ±10% | 0.95 |
| 16 | CL10X475KO8NQN □ | | 4.7 μF | 16 | ±10% | 0.95 |
| 17 | CL10X475KP5NNN □ | | 4.7 μF | 10 | ±10% | 0.90 |
| 18 | CL10X475KQ8NNN □ | | 4.7 μF | 6.3 | ±10% | 0.90 |
| 19 | CL10X475KR8NNN □ | | 4.7 μF | 4 | ±10% | 0.90 |
| 20 | CL10X106MP8NNN □ | | 10 μF | 10 | ±20% | 0.90 |
| 21 | CL10X106KQ8NNN □ | | 10 μF | 6.3 | ±10% | 0.90 |
| 22 | CL10X106KR8NNN □ | | 10 μF | 4 | ±10% | 0.90 |
| 1 | CL21X105KAFNNN □ | 2.00×1.25 | 1 μF | 25 | ±10% | 1.35 |
| 2 | CL21X105KOFNNN □ | | 1 μF | 16 | ±10% | 1.35 |
| 3 | CL21X105KPFNNN □ | | 1 μF | 10 | ±10% | 1.35 |
| 4 | CL21X105KQFNNN □ | | 1 μF | 6.3 | ±10% | 1.35 |
| 5 | CL21X105KRFNNN □ | | 1 μF | 4 | ±10% | 1.35 |
| 6 | CL21X225KAFNNN □ | | 2.2 μF | 25 | ±10% | 1.35 |
| 7 | CL21X225KOFNNN □ | | 2.2 μF | 16 | ±10% | 1.35 |
| 8 | CL21X225KPFNNN □ | | 2.2 μF | 10 | ±10% | 1.35 |
| 9 | CL21X225KQFNNN □ | | 2.2 μF | 6.3 | ±10% | 1.35 |
| 10 | CL21X225KRFNNN □ | | 2.2 μF | 4 | ±10% | 1.35 |
| 11 | CL21X475KAQNNN □ | | 4.7 μF | 25 | ±10% | 1.40 |
| 12 | CL21X475KOFNNN □ | | 4.7 μF | 16 | ±10% | 1.35 |
| 13 | CL21X475KPFNNN □ | | 4.7 μF | 10 | ±10% | 1.35 |
| 14 | CL21X475KQFNNN □ | | 4.7 μF | 6.3 | ±10% | 1.35 |

※ □ mark means packaging code. If you want to learn the code or quantity in detail, please see p74.

- Part Numbering System
- Standard & High Capacitors
- Super Small Size Capacitors
- High-Q Capacitors
- Medium-High Voltage Capacitors
- Array Type Capacitors
- Low ESL Capacitors
- Reliability Test Condition
- Premium Capacitors for Automotive Applications
- Packaging Specification
- Application Manual for Surface Mounting



Product Lineup (Standard & High Capacitors-X6S)

| | Part Number | Size L x W (mm) | Capacitance | Rated Voltage (Vdc) | Capacitance Tolerance | Thickness Max.(mm) |
|----|------------------|--------------------|-------------|------------------------|-----------------------|--------------------|
| 15 | CL21X475KRFNNN □ | 2.00×1.25 | 4.7 μF | 4 | ±10% | 1.35 |
| 16 | CL21X106KACLRN □ | | 10 μF | 25 | ±10% | 0.95 |
| 17 | CL21X106KAYNNN □ | | 10 μF | 25 | ±10% | 1.45 |
| 18 | CL21X106KOYNNN □ | | 10 μF | 16 | ±10% | 1.45 |
| 19 | CL21X106KPCLNN □ | | 10 μF | 10 | ±10% | 0.95 |
| 20 | CL21X106KPYNNN □ | | 10 μF | 10 | ±10% | 1.45 |
| 21 | CL21X106KQQNNN □ | | 10 μF | 6.3 | ±10% | 1.40 |
| 22 | CL21X106KRQNNN □ | | 10 μF | 4 | ±10% | 1.40 |
| 23 | CL21X106KRCLNN □ | | 10 μF | 4 | ±10% | 0.95 |
| 24 | CL21X226MQQNNN □ | | 22 μF | 6.3 | ±20% | 1.40 |
| 25 | CL21X226MRQNNN □ | | 22 μF | 4 | ±20% | 1.40 |
| 26 | CL21X476MRYNNN □ | | 47 μF | 4 | ±20% | 1.45 |
| 1 | CL31X475KAHNNN □ | | 3.20×1.60 | 4.7 μF | 25 | ±10% |
| 2 | CL31X475KACLNN □ | 4.7 μF | | 25 | ±10% | 0.95 |
| 3 | CL31X475KOHNNN □ | 4.7 μF | | 16 | ±10% | 1.80 |
| 4 | CL31X475KPHNNN □ | 4.7 μF | | 10 | ±10% | 1.80 |
| 5 | CL31X475MQHNNN □ | 4.7 μF | | 6.3 | ±20% | 1.80 |
| 6 | CL31X475KRHNNN □ | 4.7 μF | | 4 | ±10% | 1.80 |
| 7 | CL31X106KACLNN □ | 10 μF | | 25 | ±10% | 0.95 |
| 8 | CL31X106KAHNNN □ | 10 μF | | 25 | ±10% | 1.80 |
| 9 | CL31X106KOHNNN □ | 10 μF | | 16 | ±10% | 1.80 |
| 10 | CL31X106KPHNNN □ | 10 μF | | 10 | ±10% | 1.80 |
| 11 | CL31X106KQHNNN □ | 10 μF | | 6.3 | ±10% | 1.80 |
| 12 | CL31X106KRHNNN □ | 10 μF | | 4 | ±10% | 1.80 |
| 13 | CL31X226KOHNNN □ | 22 μF | | 16 | ±10% | 1.80 |
| 14 | CL31X226KPHNNN □ | 22 μF | | 10 | ±10% | 1.80 |
| 15 | CL31X226KQHNNN □ | 22 μF | | 6.3 | ±10% | 1.80 |
| 16 | CL31X226KRHNNN □ | 22 μF | | 4 | ±10% | 1.80 |
| 17 | CL31X107MQHNNN □ | 100 μF | | 6.3 | ±20% | 1.80 |
| 18 | CL31X107MRHNNN □ | 100 μF | | 4 | ±20% | 1.80 |
| 1 | CL32X106KAUNNN □ | 3.20×2.50 | 10 μF | 25 | ±10% | 2.00 |
| 2 | CL32X106KOJNNN □ | | 10 μF | 16 | ±10% | 2.70 |
| 3 | CL32X106KPJNNN □ | | 10 μF | 10 | ±10% | 2.70 |
| 4 | CL32X106KQJNNN □ | | 10 μF | 6.3 | ±10% | 2.70 |
| 5 | CL32X106KRJNNN □ | | 10 μF | 4 | ±10% | 2.70 |
| 6 | CL32X226KAJNNN □ | | 22 μF | 25 | ±10% | 2.70 |
| 7 | CL32X226KOJNNN □ | | 22 μF | 16 | ±10% | 2.70 |
| 8 | CL32X226KPJNNN □ | | 22 μF | 10 | ±10% | 2.70 |
| 9 | CL32X226KQJNNN □ | | 22 μF | 6.3 | ±10% | 2.70 |
| 10 | CL32X226KRJNNN □ | | 22 μF | 4 | ±10% | 2.70 |
| 11 | CL32X476MPJNNN □ | | 47 μF | 10 | ±20% | 2.70 |
| 12 | CL32X476KQJNNN □ | | 47 μF | 6.3 | ±10% | 2.70 |
| 13 | CL32X476KRJNNN □ | | 47 μF | 4 | ±10% | 2.70 |
| 14 | CL32X107MQVNNN □ | | 100 μF | 6.3 | ±20% | 2.80 |
| 15 | CL32X107MRVNNN □ | | 100 μF | 4 | ±20% | 2.80 |

※ □ mark means packaging code. If you want to learn the code or quantity in detail, please see p74.

Product Lineup (Standard & High Capacitors-X7R, X7S)

| | Part Number | Size L x W (mm) | Capacitance | Rated Voltage (Vdc) | Capacitance Tolerance | Thickness Max.(mm) |
|----|------------------|-----------------|-------------|---------------------|-----------------------|--------------------|
| 1 | CL05B151KB5NNN □ | 1.00×0.50 | 150pF | 50 | ±10% | 0.55 |
| 2 | CL05B181KB5NNN □ | | 180pF | 50 | ±10% | 0.55 |
| 3 | CL05B221KB5NNN □ | | 220pF | 50 | ±10% | 0.55 |
| 4 | CL05B271KB5NNN □ | | 270pF | 50 | ±10% | 0.55 |
| 5 | CL05B331KB5NNN □ | | 330pF | 50 | ±10% | 0.55 |
| 6 | CL05B391KB5NNN □ | | 390nF | 50 | ±10% | 0.55 |
| 7 | CL05B471KB5NNN □ | | 470pF | 50 | ±10% | 0.55 |
| 8 | CL05B561KB5NNN □ | | 560pF | 50 | ±10% | 0.55 |
| 9 | CL05B681KB5NNN □ | | 680pF | 50 | ±10% | 0.55 |
| 10 | CL05B102KB5NNN □ | | 1nF | 50 | ±10% | 0.55 |
| 11 | CL05B122KB5NNN □ | | 1.2nF | 50 | ±10% | 0.55 |
| 12 | CL05B152KB5NNN □ | | 1.5nF | 50 | ±10% | 0.55 |
| 13 | CL05B182KB5NNN □ | | 1.8nF | 50 | ±10% | 0.55 |
| 14 | CL05B222KB5NNN □ | | 2.2nF | 50 | ±10% | 0.55 |
| 15 | CL05B272KB5NNN □ | | 2.7nF | 50 | ±10% | 0.55 |
| 16 | CL05B332KB5NNN □ | | 3.3nF | 50 | ±10% | 0.55 |
| 17 | CL05B472KB5NNN □ | | 4.7nF | 50 | ±10% | 0.55 |
| 18 | CL05B562KB5NNN □ | | 5.6nF | 50 | ±10% | 0.55 |
| 19 | CL05B682KB5NNN □ | | 6.8nF | 50 | ±10% | 0.55 |
| 20 | CL05B822KB5NNN □ | | 8.2nF | 50 | ±10% | 0.55 |
| 21 | CL05B103KB5NNN □ | | 10nF | 50 | ±10% | 0.55 |
| 22 | CL05B123KA5NNN □ | | 12nF | 25 | ±10% | 0.55 |
| 23 | CL05B153KA5NNN □ | | 15nF | 25 | ±10% | 0.55 |
| 24 | CL05B223KA5NNN □ | | 22nF | 25 | ±10% | 0.55 |
| 25 | CL05B273KO5NNN □ | | 27nF | 16 | ±10% | 0.55 |
| 26 | CL05B333KO5NNN □ | | 33nF | 16 | ±10% | 0.55 |
| 27 | CL05B393KO5NNN □ | | 39nF | 16 | ±10% | 0.55 |
| 28 | CL05B473KO5NNN □ | | 47nF | 16 | ±10% | 0.55 |
| 29 | CL05B563KO5NNN □ | | 56nF | 16 | ±10% | 0.55 |
| 30 | CL05B683KO5NNN □ | | 68nF | 16 | ±10% | 0.55 |
| 31 | CL05B823KO5NNN □ | | 82nF | 16 | ±10% | 0.55 |
| 32 | CL05B104KO5NNN □ | | 100nF | 16 | ±10% | 0.55 |
| 33 | CL05B224KO5NNN □ | | 220nF | 16 | ±10% | 0.55 |
| 34 | CL05B474KP5NNN □ | | 470nF | 10 | ±10% | 0.55 |
| 35 | CL05B105KQ5NQN □ | | 1μF | 6.3 | ±10% | 0.60 |
| 1 | CL05Y474KP5NNN □ | 1.00×0.50 | 470nF | 10 | ±10% | 0.55 |
| 37 | CL10B101KB8NNN □ | 1.60×0.80 | 100pF | 50 | ±10% | 0.90 |
| 38 | CL10B121KB8NNN □ | | 120pF | 50 | ±10% | 0.90 |
| 39 | CL10B151KB8NNN □ | | 150pF | 50 | ±10% | 0.90 |
| 40 | CL10B181KB8NNN □ | | 180pF | 50 | ±10% | 0.90 |
| 41 | CL10B201KB8NNN □ | | 200pF | 50 | ±10% | 0.90 |
| 42 | CL10B221KB8NNN □ | | 220pF | 50 | ±10% | 0.90 |
| 43 | CL10B271KB8NNN □ | | 270pF | 50 | ±10% | 0.90 |
| 44 | CL10B331KB8NNN □ | | 330pF | 50 | ±10% | 0.90 |
| 45 | CL10B391KB8NNN □ | | 390pF | 50 | ±10% | 0.90 |
| 46 | CL10B471KB8NNN □ | | 470pF | 50 | ±10% | 0.90 |
| 47 | CL10B561KB8NNN □ | | 560pF | 50 | ±10% | 0.90 |
| 48 | CL10B681KB8NNN □ | | 680pF | 50 | ±10% | 0.90 |
| 49 | CL10B751KB8NNN □ | | 750pF | 50 | ±10% | 0.90 |
| 50 | CL10B821KB8NNN □ | | 820pF | 50 | ±10% | 0.90 |
| 51 | CL10B102KB8NNN □ | | 1nF | 50 | ±10% | 0.90 |
| 52 | CL10B122KB8NNN □ | | 1.2nF | 50 | ±10% | 0.90 |

※ □ mark means packaging code. If you want to learn the code or quantity in detail, please see p74.

- Part Numbering System
- Standard & High Capacitors
- Super Small Size Capacitors
- High-Q Capacitors
- Medium-High Voltage Capacitors
- Array Type Capacitors
- Low ESL Capacitors
- Reliability Test Condition
- Premium Capacitors for Automotive Applications
- Packaging Specification
- Application Manual for Surface Mounting



Product Lineup (Standard & High Capacitors-X7R)

| | Part Number | Size L x W (mm) | Capacitance | Rated Voltage (Vdc) | Capacitance Tolerance | Thickness Max.(mm) | |
|----|------------------|--------------------|-------------|------------------------|-----------------------|--------------------|------|
| 53 | CL10B152KB8NNN □ | 1.60×0.80 | 1.5nF | 50 | ± 10% | 0.90 | |
| 54 | CL10B182KB8NNN □ | | 1.8nF | 50 | ± 10% | 0.90 | |
| 55 | CL10B202KB8NNN □ | | 2nF | 50 | ± 10% | 0.90 | |
| 56 | CL10B222KB8NNN □ | | 2.2nF | 50 | ± 10% | 0.90 | |
| 57 | CL10B332KB8NNN □ | | 3.3nF | 50 | ± 10% | 0.90 | |
| 58 | CL10B392KB8NNN □ | | 3.9nF | 50 | ± 10% | 0.90 | |
| 59 | CL10B472KB8NNN □ | | 4.7nF | 50 | ± 10% | 0.90 | |
| 60 | CL10B562KB8NNN □ | | 5.6nF | 50 | ± 10% | 0.90 | |
| 61 | CL10B682KB8NNN □ | | 6.8nF | 50 | ± 10% | 0.90 | |
| 62 | CL10B822KB8NNN □ | | 8.2nF | 50 | ± 10% | 0.90 | |
| 63 | CL10B103JB8NNN □ | | 10nF | 50 | ± 5% | 0.90 | |
| 64 | CL10B123KB8NNN □ | | 12nF | 50 | ± 10% | 0.90 | |
| 65 | CL10B153KB8NNN □ | | 15nF | 50 | ± 10% | 0.90 | |
| 66 | CL10B183KB8NNN □ | | 18nF | 50 | ± 10% | 0.90 | |
| 67 | CL10B223KB8NNN □ | | 22nF | 50 | ± 10% | 0.90 | |
| 68 | CL10B273KB8NNN □ | | 27nF | 50 | ± 10% | 0.90 | |
| 69 | CL10B333JB8NNN □ | | 33nF | 50 | ± 5% | 0.90 | |
| 70 | CL10B393KB8NNN □ | | 39nF | 50 | ± 10% | 0.90 | |
| 71 | CL10B473KB8NNN □ | | 47nF | 50 | ± 10% | 0.90 | |
| 72 | CL10B563KB8NNN □ | | 56nF | 50 | ± 10% | 0.90 | |
| 73 | CL10B683KB8NNN □ | | 68nF | 50 | ± 10% | 0.90 | |
| 74 | CL10B823KB8NNN □ | | 82nF | 50 | ± 10% | 0.90 | |
| 75 | CL10B104KB8NNN □ | | 100nF | 50 | ± 10% | 0.90 | |
| 76 | CL10B124KO8NNN □ | | 120nF | 16 | ± 10% | 0.90 | |
| 77 | CL10B154KA8NNN □ | | 150nF | 25 | ± 10% | 0.90 | |
| 78 | CL10B224KA8NNN □ | | 220nF | 25 | ± 10% | 0.90 | |
| 79 | CL10B474KA8NNN □ | | 470nF | 25 | ± 10% | 0.90 | |
| 80 | CL10B684KO8NNN □ | | 680nF | 16 | ± 10% | 0.90 | |
| 81 | CL10B105KA8NNN □ | | 1μF | 25 | ± 10% | 0.90 | |
| 82 | CL10B225KP8NNN □ | | 2.2μF | 10 | ± 10% | 0.90 | |
| 1 | CL21B151KBANNN □ | | 2.00×1.25 | 150pF | 50 | ± 10% | 0.75 |
| 2 | CL21B181KBANNN □ | | | 180pF | 50 | ± 10% | 0.75 |
| 3 | CL21B221KBANNN □ | 220pF | | 50 | ± 10% | 0.75 | |
| 4 | CL21B331KBANNN □ | 330pF | | 50 | ± 10% | 0.75 | |
| 5 | CL21B391KBANNN □ | 390pF | | 50 | ± 10% | 0.75 | |
| 6 | CL21B471KBANNN □ | 470pF | | 50 | ± 10% | 0.75 | |
| 7 | CL21B511KBANNN □ | 510pF | | 50 | ± 10% | 0.75 | |
| 8 | CL21B561KBANNN □ | 560pF | | 50 | ± 10% | 0.75 | |
| 9 | CL21B681KBANNN □ | 680pF | | 50 | ± 10% | 0.75 | |
| 10 | CL21B821KBANNN □ | 820pF | | 50 | ± 10% | 0.75 | |
| 11 | CL21B102KBANNN □ | 1nF | | 50 | ± 10% | 0.75 | |
| 12 | CL21B122KBANNN □ | 1.2nF | | 50 | ± 10% | 0.75 | |
| 13 | CL21B152KBANNN □ | 1.5nF | | 50 | ± 10% | 0.75 | |
| 14 | CL21B182KBANNN □ | 1.8nF | | 50 | ± 10% | 0.75 | |
| 15 | CL21B202KBANNN □ | 2nF | | 50 | ± 10% | 0.75 | |
| 16 | CL21B222KBANNN □ | 2.2nF | | 50 | ± 10% | 0.75 | |
| 17 | CL21B272KBANNN □ | 2.7nF | | 50 | ± 10% | 0.75 | |
| 18 | CL21B332KBANNN □ | 3.3nF | | 50 | ± 10% | 0.75 | |
| 19 | CL21B472KBANNN □ | 4.7nF | | 50 | ± 10% | 0.75 | |
| 20 | CL21B562KBANNN □ | 5.6nF | | 50 | ± 10% | 0.75 | |
| 21 | CL21B682KBANNN □ | 6.8nF | | 50 | ± 10% | 0.75 | |

※ □ mark means packaging code. If you want to learn the code or quantity in detail, please see p74.

Product Lineup (Standard & High Capacitors-X7R)

| | Part Number | Size L x W (mm) | Capacitance | Rated Voltage (Vdc) | Capacitance Tolerance | Thickness Max.(mm) |
|----|------------------|-----------------|-------------|---------------------|-----------------------|--------------------|
| 22 | CL21B103KBANNN □ | 2.00×1.25 | 10nF | 50 | ±10% | 0.75 |
| 23 | CL21B123KBANNN □ | | 12nF | 50 | ±10% | 0.75 |
| 24 | CL21B153KBANNN □ | | 15nF | 50 | ±10% | 0.75 |
| 25 | CL21B333KBANNN □ | | 33nF | 50 | ±10% | 0.75 |
| 26 | CL21B393KBANNN □ | | 39nF | 50 | ±10% | 0.75 |
| 27 | CL21B473KBANNN □ | | 47nF | 50 | ±10% | 0.75 |
| 28 | CL21B563KBCNNN □ | | 56nF | 50 | ±10% | 0.95 |
| 29 | CL21B683KAANNN □ | | 68nF | 25 | ±10% | 0.75 |
| 30 | CL21B683JBCNNN □ | | 68nF | 50 | ±5% | 0.95 |
| 31 | CL21B683KBFNNN □ | | 68nF | 50 | ±10% | 1.35 |
| 32 | CL21B823KBCNNN □ | | 82nF | 50 | ±10% | 0.95 |
| 33 | CL21B823KBFNNN □ | | 82nF | 50 | ±10% | 1.35 |
| 34 | CL21B104KACNNN □ | | 100nF | 25 | ±10% | 0.95 |
| 35 | CL21B104KBCNNN □ | | 100nF | 50 | ±10% | 0.95 |
| 36 | CL21B104KBFNNN □ | | 100nF | 50 | ±10% | 1.35 |
| 37 | CL21B124KBFNNN □ | | 120nF | 50 | ±10% | 1.35 |
| 38 | CL21B124KACNNN □ | | 120nF | 25 | ±10% | 0.95 |
| 39 | CL21B154KOANNN □ | | 150nF | 16 | ±10% | 0.75 |
| 40 | CL21B154KBFNNN □ | | 150nF | 50 | ±10% | 1.35 |
| 41 | CL21B224KBFNNN □ | | 220nF | 50 | ±10% | 1.35 |
| 42 | CL21B334KAFNNN □ | | 330nF | 25 | ±10% | 1.35 |
| 43 | CL21B474KAFNNN □ | | 470nF | 25 | ±10% | 1.35 |
| 44 | CL21B684KOFNNN □ | | 680nF | 16 | ±10% | 1.35 |
| 45 | CL21B105KBFNNN □ | | 1μF | 50 | ±10% | 1.35 |
| 46 | CL21B155KAFNNN □ | | 1.5μF | 25 | ±10% | 1.35 |
| 47 | CL21B225KAFNNN □ | | 2.2μF | 25 | ±10% | 1.35 |
| 48 | CL21B475KQNNN □ | | 4.7μF | 6.3 | ±10% | 1.40 |
| 49 | CL21B475KAFNNN □ | | 4.7μF | 25 | ±10% | 1.35 |
| 50 | CL21B106KQNNN □ | | 10μF | 16 | ±10% | 1.40 |
| 1 | CL31B221KBCNNN □ | | 3.20×1.60 | 220pF | 50 | ±10% |
| 2 | CL31B331KBCNNN □ | 330pF | | 50 | ±10% | 1.00 |
| 3 | CL31B471KBCNNN □ | 470pF | | 50 | ±10% | 1.00 |
| 4 | CL31B561KBCNNN □ | 560pF | | 50 | ±10% | 1.00 |
| 5 | CL31B152KBCNNN □ | 1.5nF | | 50 | ±10% | 1.00 |
| 6 | CL31B222KBCNNN □ | 2.2nF | | 50 | ±10% | 1.00 |
| 7 | CL31B332KBCNNN □ | 3.3nF | | 50 | ±10% | 1.00 |
| 8 | CL31B472KBCNNN □ | 4.7nF | | 50 | ±10% | 1.00 |
| 9 | CL31B473KBCNNN □ | 47nF | | 50 | ±10% | 1.00 |
| 10 | CL31B562KBCNNN □ | 5.6nF | | 50 | ±10% | 1.00 |
| 11 | CL31B682KBCNNN □ | 6.8nF | | 50 | ±10% | 1.00 |
| 12 | CL31B822KBCNNN □ | 8.2nF | | 50 | ±10% | 1.00 |
| 13 | CL31B103KBCNNN □ | 10nF | | 50 | ±10% | 1.00 |
| 14 | CL31B123KBCNNN □ | 12nF | | 50 | ±10% | 1.00 |
| 15 | CL31B153KBCNNN □ | 15nF | | 50 | ±10% | 1.00 |
| 16 | CL31B223KBCNNN □ | 22nF | | 50 | ±10% | 1.00 |
| 17 | CL31B333KBCNNN □ | 33nF | | 50 | ±10% | 1.00 |
| 18 | CL31B683KBCNNN □ | 68nF | | 50 | ±10% | 1.00 |
| 19 | CL31B104KBCNNN □ | 100nF | | 50 | ±10% | 1.00 |
| 20 | CL31B154KBCNNN □ | 150nF | | 50 | ±10% | 1.00 |
| 21 | CL31B224KBFNNN □ | 220nF | | 50 | ±10% | 1.40 |
| 22 | CL31B334KBFNNN □ | 330nF | | 50 | ±10% | 1.40 |

※ □ mark means packaging code. If you want to learn the code or quantity in detail, please see p74.

Part Numbering System

Standard & High Capacitors

Super Small Size Capacitors

High-Q Capacitors

Medium-High Voltage Capacitors

Array Type Capacitors

Low ESL Capacitors

Reliability Test Condition

Premium Capacitors for Automotive Applications

Packaging Specification

Application Manual for Surface Mounting



Product Lineup (Standard & High Capacitors-X7R)

| | Part Number | Size L x W (mm) | Capacitance | Rated Voltage (Vdc) | Capacitance Tolerance | Thickness Max.(mm) | |
|----|------------------|--------------------|-------------|---------------------------|--------------------------|-----------------------|------|
| 23 | CL31B334KACNNN □ | 3.20×1.60 | 330nF | 25 | ± 10% | 1.00 | |
| 24 | CL31B474KBHNNN □ | | 470nF | 50 | ± 10% | 1.80 | |
| 25 | CL31B474MAFNNN □ | | 470nF | 25 | ± 20% | 1.40 | |
| 26 | CL31B684KOCNNN □ | | 680nF | 16 | ± 10% | 1.00 | |
| 27 | CL31B684KBHNNN □ | | 680nF | 50 | ± 10% | 1.80 | |
| 28 | CL31B105KBHNNN □ | | 1 μ F | 50 | ± 10% | 1.80 | |
| 29 | CL31B225KAHNNN □ | | 2.2 μ F | 25 | ± 10% | 1.80 | |
| 30 | CL31B335KAHNNN □ | | 3.3 μ F | 25 | ± 10% | 1.80 | |
| 31 | CL31B475KBHNNN □ | | 4.7 μ F | 50 | ± 10% | 1.80 | |
| 32 | CL31B106KBHNNN □ | | 10 μ F | 50 | ± 10% | 1.80 | |
| 33 | CL31B226KPHNNN □ | | 22 μ F | 10 | ± 10% | 1.80 | |
| 1 | CL32B104KBFNNN □ | | 3.20×2.50 | 100nF | 50 | ± 10% | 1.45 |
| 2 | CL32B154KBFNNN □ | | | 150nF | 50 | ± 10% | 1.45 |
| 3 | CL32B224KBFNNN □ | 220nF | | 50 | ± 10% | 1.45 | |
| 4 | CL32B334KBFNNN □ | 330nF | | 50 | ± 10% | 1.45 | |
| 5 | CL32B474KBFNNN □ | 470nF | | 50 | ± 10% | 1.45 | |
| 6 | CL32B105KBHNNN □ | 1 μ F | | 50 | ± 10% | 1.80 | |
| 7 | CL32B225KBJNNN □ | 2.2 μ F | | 50 | ± 10% | 2.70 | |
| 8 | CL32B225KAINNN □ | 2.2 μ F | | 25 | ± 10% | 2.20 | |
| 9 | CL32B475KBJNNN □ | 4.7 μ F | | 50 | ± 10% | 2.70 | |
| 10 | CL32B475KBUYNN □ | 4.7 μ F | | 50 | ± 10% | 2.00 | |
| 11 | CL32B475KOINNN □ | 4.7 μ F | | 16 | ± 10% | 2.20 | |
| 12 | CL32B106KLJNNN □ | 10 μ F | | 35 | ± 10% | 2.70 | |
| 13 | CL32B106KAULNN □ | 10 μ F | | 25 | ± 10% | 2.00 | |
| 14 | CL32B106KPINNN □ | 10 μ F | | 10 | ± 10% | 2.20 | |
| 15 | CL32B226KAJNNN □ | 22 μ F | | 25 | ± 10% | 2.70 | |
| 16 | CL32B476MQJNN □ | 47 μ F | | 6.3 | ± 20% | 2.70 | |

※ □ mark means packaging code. If you want to learn the code or quantity in detail, please see p74.

Product Lineup (Standard & High Capacitors-Y5V)

| | Part Number | Size L x W (mm) | Capacitance | Rated Voltage (Vdc) | Capacitance Tolerance | Thickness Max.(mm) |
|----|------------------|-----------------|-------------|---------------------|-----------------------|--------------------|
| 1 | CL05F224ZO5NNN □ | 1.00×0.50 | 0.22 μF | 16 | +80/-20% | 0.55 |
| 2 | CL05F224ZP5NNN □ | | 0.22 μF | 10 | +80/-20% | 0.55 |
| 3 | CL05F224ZQ5NNN □ | | 0.22 μF | 6.3 | +80/-20% | 0.55 |
| 4 | CL05F474ZP5NNN □ | | 0.47 μF | 10 | +80/-20% | 0.55 |
| 5 | CL05F474ZQ5NNN □ | | 0.47 μF | 6.3 | +80/-20% | 0.55 |
| 6 | CL05F105ZQ5NNN □ | | 1 μF | 6.3 | +80/-20% | 0.55 |
| 1 | CL10F474ZB8NNN □ | 1.60×0.80 | 0.47 μF | 50 | +80/-20% | 0.90 |
| 2 | CL10F474ZA8NNN □ | | 0.47 μF | 25 | +80/-20% | 0.90 |
| 3 | CL10F474ZO8NNN □ | | 0.47 μF | 16 | +80/-20% | 0.90 |
| 4 | CL10F474ZP8NNN □ | | 0.47 μF | 10 | +80/-20% | 0.90 |
| 5 | CL10F105ZO8NNN □ | | 1 μF | 16 | +80/-20% | 0.90 |
| 6 | CL10F105ZP8NNN □ | | 1 μF | 10 | +80/-20% | 0.90 |
| 7 | CL10F225ZP8NNN □ | | 2.2 μF | 10 | +80/-20% | 0.90 |
| 8 | CL10F225ZQ8NNN □ | | 2.2 μF | 6.3 | +80/-20% | 0.90 |
| 9 | CL10F475ZQ8NNN □ | | 4.7 μF | 6.3 | +80/-20% | 0.90 |
| 1 | CL21F105ZBFNNN □ | 2.00×1.25 | 1 μF | 50 | +80/-20% | 1.35 |
| 2 | CL21F105ZAFNNN □ | | 1 μF | 25 | +80/-20% | 1.35 |
| 3 | CL21F105ZOFNNN □ | | 1 μF | 16 | +80/-20% | 1.35 |
| 4 | CL21F225ZAFNNN □ | | 2.2 μF | 25 | +80/-20% | 1.35 |
| 5 | CL21F225ZOFNNN □ | | 2.2 μF | 16 | +80/-20% | 1.35 |
| 6 | CL21F475ZQFNNN □ | | 4.7 μF | 6.3 | +80/-20% | 1.35 |
| 7 | CL21F475ZOFNNN □ | | 4.7 μF | 16 | +80/-20% | 1.35 |
| 8 | CL21F475ZPFNNN □ | | 4.7 μF | 10 | +80/-20% | 1.35 |
| 9 | CL21F106ZPFNNN □ | | 10 μF | 10 | +80/-20% | 1.35 |
| 10 | CL21F106ZPCLNN □ | | 10 μF | 10 | +80/-20% | 0.95 |
| 11 | CL21F106ZQFNNN □ | | 10 μF | 6.3 | +80/-20% | 1.35 |
| 12 | CL21F106ZQCLNN □ | | 10 μF | 6.3 | +80/-20% | 0.95 |
| 1 | CL31F475ZOFNNN □ | 3.20×1.60 | 4.7 μF | 16 | +80/-20% | 1.40 |
| 2 | CL31F475ZPFNNN □ | | 4.7 μF | 10 | +80/-20% | 1.40 |
| 3 | CL31F475ZQFNNN □ | | 4.7 μF | 6.3 | +80/-20% | 1.40 |
| 4 | CL31F106ZOHNNN □ | | 10 μF | 16 | +80/-20% | 1.80 |
| 5 | CL31F106ZPHNNN □ | | 10 μF | 10 | +80/-20% | 1.80 |
| 6 | CL31F106ZQHNNN □ | | 10 μF | 6.3 | +80/-20% | 1.80 |
| 7 | CL31F226ZPHNNN □ | | 22 μF | 10 | +80/-20% | 1.80 |
| 8 | CL31F226ZQHNNN □ | | 22 μF | 6.3 | +80/-20% | 1.80 |
| 1 | CL32F106ZAHNNN □ | 3.20×2.50 | 10 μF | 25 | +80/-20% | 1.80 |
| 2 | CL32F106ZOELNN □ | | 10 μF | 16 | +80/-20% | 1.20 |
| 3 | CL32F226ZPJNNN □ | | 22 μF | 10 | +80/-20% | 2.70 |
| 4 | CL32F226ZPJLNN □ | | 22 μF | 10 | +80/-20% | 2.70 |
| 5 | CL32F476ZQINNN □ | | 47 μF | 6.3 | +80/-20% | 2.20 |
| 6 | CL32F107ZQJNNN □ | | 100 μF | 6.3 | +80/-20% | 2.70 |

※ □ mark means packaging code. If you want to learn the code or quantity in detail, please see p74.

- Part Numbering System
- Standard & High Capacitors
- Super Small Size Capacitors
- High-Q Capacitors
- Medium-High Voltage Capacitors
- Array Type Capacitors
- Low ESL Capacitors
- Reliability Test Condition
- Premium Capacitors for Automotive Applications
- Packaging Specification
- Application Manual for Surface Mounting

Super Small Size Capacitors



Feature

- Small chip size
- 02 and 03 series (High-Q) MLCC shows very low ESR value.
- 02 and 03 Series are suited to only reflow soldering
- 02 and 03 Series are suited to miniature RF module, portable equipment and high frequency circuit

Application

- VCO, Tuner, RF Module
- MCM Module
- Mobile phone, Wireless LAN, Note PC

Structure and Dimensions



| Code | EIA Code | Dimension (mm) | | | |
|------|----------|----------------|----------------|----------------|-----------------|
| | | L | W | T | BW |
| 02 | 01005 | 0.4 ± 0.02 | 0.2 ± 0.02 | 0.2 ± 0.02 | 0.10 ± 0.03 |
| 03 | 0201 | 0.6 ± 0.03 | 0.3 ± 0.03 | 0.3 ± 0.03 | 0.15 ± 0.05 |

Super Small Size Capacitance Table (C0G)

| TC | Size (mm) | Vr(V) | Capacitance (pF) | | | | | | | |
|-----|-------------|-------|------------------|---|----|----|----|-----|-----|-----|
| | | | 0.5 | 1 | 10 | 22 | 47 | 100 | 220 | 330 |
| C0G | 01005(0402) | 6.3 | | | | | | | | |
| | | 16 | | | | | | | | |
| | 0201(0603) | 25 | | | | | | | | |
| | | 50 | | | | | | | | |

Super Small Size Capacitance Table (High-Q)

| TC | Size (mm) | Vr(V) | Capacitance (pF) | | | | | | | |
|-----|-------------|-------|------------------|---|----|----|----|----|----|-----|
| | | | 0.2 | 1 | 10 | 15 | 27 | 33 | 47 | 100 |
| C0G | 01005(0402) | 25 | | | | | | | | |
| | 0201(0603) | 25 | | | | | | | | |
| | | 50 | | | | | | | | |

Super Small Size Capacitance Table (X7R,X6S)

| TC | Size (mm) | Vr(V) | Capacitance (nF) | | | | | | | |
|-----|-------------|-------|------------------|------|------|---|-----|-----|-----|----|
| | | | 0.1 | 0.22 | 0.47 | 1 | 2.2 | 3.3 | 4.7 | 10 |
| X7R | 01005(0402) | 10 | | | | | | | | |
| | 0201(0603) | 10 | | | | | | | | |
| | | 16 | | | | | | | | |
| | | 25 | | | | | | | | |
| | | 50 | | | | | | | | |
| X6S | 0201(0603) | 4 | | | | | | | | |

Super Small Size Capacitance Table (X5R, Y5V)

| TC | Size (mm) | Vr(V) | Capacitance (μF) | | | | | | | |
|-----|-------------|-------|------------------|-----|------|------|---|-----|-----|----|
| | | | 0.01 | 0.1 | 0.22 | 0.47 | 1 | 2.2 | 4.7 | 10 |
| X5R | 01005(0402) | 6.3 | | | | | | | | |
| | | 10 | | | | | | | | |
| | | 16 | | | | | | | | |
| | 0201(0603) | 4 | | | | | | | | |
| | | 6.3 | | | | | | | | |
| | | 10 | | | | | | | | |
| | | 16 | | | | | | | | |
| | 25 | | | | | | | | | |
| Y5V | 0201(0603) | 6.3 | | | | | | | | |

Part Numbering System

Standard & High Capacitors

Super Small Size Capacitors

High-Q Capacitors

Medium-High Voltage Capacitors

Array Type Capacitors

Low ESL Capacitors

Reliability Test Condition

Premium Capacitors for Automotive Applications

Packaging Specification

Application Manual for Surface Mounting



Product Lineup (Super Small Size Capacitors-C0G)

| | Part Number | Size L x W (mm) | Capacitance | Rated Voltage (Vdc) | Capacitance Tolerance | Thickness Max.(mm) | |
|----|------------------|-----------------|-------------|---------------------|-----------------------|--------------------|--------|
| 1 | CL02C0R5CO2ANN □ | 0.40×0.20 | 0.5 pF | 16 | ±0.25 pF | 0.22 | |
| 2 | CL02C010CO2ANN □ | | 1.0 pF | 16 | ±0.25 pF | 0.22 | |
| 3 | CL02C1R2CO2ANN □ | | 1.2 pF | 16 | ±0.25 pF | 0.22 | |
| 4 | CL02C1R5CO2ANN □ | | 1.5 pF | 16 | ±0.25 pF | 0.22 | |
| 5 | CL02C1R8CO2ANN □ | | 1.8 pF | 16 | ±0.25 pF | 0.22 | |
| 6 | CL02C020CO2ANN □ | | 2.0 pF | 16 | ±0.25 pF | 0.22 | |
| 7 | CL02C2R2CO2ANN □ | | 2.2 pF | 16 | ±0.25 pF | 0.22 | |
| 8 | CL02C2R7CO2ANN □ | | 2.7 pF | 16 | ±0.25 pF | 0.22 | |
| 9 | CL02C030CO2ANN □ | | 3.0 pF | 16 | ±0.25 pF | 0.22 | |
| 10 | CL02C3R3CO2ANN □ | | 3.3 pF | 16 | ±0.25 pF | 0.22 | |
| 11 | CL02C3R9CO2ANN □ | | 3.9 pF | 16 | ±0.25 pF | 0.22 | |
| 12 | CL02C4R7CO2ANN □ | | 4.7 pF | 16 | ±0.25 pF | 0.22 | |
| 13 | CL02C5R6DO2ANN □ | | 5.6 pF | 16 | ±0.5 pF | 0.22 | |
| 14 | CL02C6R8DO2ANN □ | | 6.8 pF | 16 | ±0.5 pF | 0.22 | |
| 15 | CL02C8R2DO2ANN □ | | 8.2 pF | 16 | ±0.5 pF | 0.22 | |
| 16 | CL02C090DO2ANN □ | | 9.0 pF | 16 | ±0.5 pF | 0.22 | |
| 17 | CL02C100JO2ANN □ | | 10 pF | 16 | ±5% | 0.22 | |
| 18 | CL02C150JO2ANN □ | | 15 pF | 16 | ±5% | 0.22 | |
| 19 | CL02C180JO2ANN □ | | 18 pF | 16 | ±5% | 0.22 | |
| 20 | CL02C220JO2ANN □ | | 22 pF | 16 | ±5% | 0.22 | |
| 21 | CL02C270JO2ANN □ | | 27 pF | 16 | ±5% | 0.22 | |
| 22 | CL02C330JO2ANN □ | | 33 pF | 16 | ±5% | 0.22 | |
| 23 | CL02C390JO2ANN □ | | 39 pF | 16 | ±5% | 0.22 | |
| 24 | CL02C470JO2ANN □ | | 47 pF | 16 | ±5% | 0.22 | |
| 25 | CL02C560JQ2ANN □ | | 56 pF | 6.3 | ±5% | 0.22 | |
| 26 | CL02C680JQ2ANN □ | | 68 pF | 6.3 | ±5% | 0.22 | |
| 27 | CL02C820JQ2ANN □ | | 82 pF | 6.3 | ±5% | 0.22 | |
| 28 | CL02C101JO2ANN □ | | 100 pF | 16 | ±5% | 0.22 | |
| 29 | CL02C101JQ2ANN □ | | 100 pF | 6.3 | ±5% | 0.22 | |
| 1 | CL02C0R5BO2GNN □ | 0.40×0.20 | 0.5 pF | 16 | ±0.25 pF | 0.22 | High-Q |
| 2 | CL02C010BO2GNN □ | | 1.0 pF | 16 | ±0.25 pF | 0.22 | High-Q |
| 3 | CL02C1R2BO2GNN □ | | 1.2 pF | 16 | ±0.25 pF | 0.22 | High-Q |
| 4 | CL02C1R5BO2GNN □ | | 1.5 pF | 16 | ±0.25 pF | 0.22 | High-Q |
| 5 | CL02C1R8BO2GNN □ | | 1.8 pF | 16 | ±0.25 pF | 0.22 | High-Q |
| 6 | CL02C2R2BO2GNN □ | | 2.2 pF | 16 | ±0.25 pF | 0.22 | High-Q |
| 7 | CL02C2R7BO2GNN □ | | 2.7 pF | 16 | ±0.25 pF | 0.22 | High-Q |
| 8 | CL02C3R3BO2GNN □ | | 3.3 pF | 16 | ±0.25 pF | 0.22 | High-Q |
| 9 | CL02C3R9BO2GNN □ | | 3.9 pF | 16 | ±0.25 pF | 0.22 | High-Q |
| 10 | CL02C4R7BO2GNN □ | | 4.7 pF | 16 | ±0.25 pF | 0.22 | High-Q |
| 11 | CL02C5R6BO2GNN □ | | 5.6 pF | 16 | ±0.25 pF | 0.22 | High-Q |
| 12 | CL02C6R8BO2GNN □ | | 6.8 pF | 16 | ±0.25 pF | 0.22 | High-Q |
| 13 | CL02C8R2BO2GNN □ | | 8.2 pF | 16 | ±0.25 pF | 0.22 | High-Q |
| 14 | CL02C100JO2GNN □ | | 10 pF | 16 | ±5% | 0.22 | High-Q |
| 15 | CL02C120JO2GNN □ | | 12 pF | 16 | ±5% | 0.22 | High-Q |
| 16 | CL02C150JO2GNN □ | | 15 pF | 16 | ±5% | 0.22 | High-Q |
| 17 | CL02C180JO2GNN □ | | 18 pF | 16 | ±5% | 0.22 | High-Q |
| 18 | CL02C220JO2GNN □ | | 22 pF | 16 | ±5% | 0.22 | High-Q |
| 19 | CL02C270JO2GNN □ | | 27 pF | 16 | ±5% | 0.22 | High-Q |
| 1 | CL03C0R5CA3GNN □ | 0.60×0.30 | 0.5 pF | 25 | ±0.25 pF | 0.33 | High-Q |
| 2 | CL03C010CA3GNN □ | | 1.0 pF | 25 | ±0.25 pF | 0.33 | High-Q |
| 3 | CL03C1R2CA3GNN □ | | 1.2 pF | 25 | ±0.25 pF | 0.33 | High-Q |
| 4 | CL03C1R5CA3GNN □ | | 1.5 pF | 25 | ±0.25 pF | 0.33 | High-Q |

※ □ mark means packaging code. If you want to learn the code or quantity in detail, please see p74.

Product Lineup (Super Small Size Capacitors-C0G)

| | Part Number | Size L x W (mm) | Capacitance | Rated Voltage (Vdc) | Capacitance Tolerance | Thickness Max.(mm) | |
|----|------------------|-----------------|-------------|---------------------|-----------------------|--------------------|--------|
| 5 | CL03C1R8CA3GNN □ | 0.60×0.30 | 1.8 pF | 25 | ±0.25 pF | 0.33 | High-Q |
| 6 | CL03C020CA3GNN □ | | 2.0 pF | 25 | ±0.25 pF | 0.33 | High-Q |
| 7 | CL03C2R2CA3GNN □ | | 2.2 pF | 25 | ±0.25 pF | 0.33 | High-Q |
| 8 | CL03C2R7CA3GNN □ | | 2.7 pF | 25 | ±0.25 pF | 0.33 | High-Q |
| 9 | CL03C030CA3GNN □ | | 3.0 pF | 25 | ±0.25 pF | 0.33 | High-Q |
| 10 | CL03C3R3CA3GNN □ | | 3.3 pF | 25 | ±0.25 pF | 0.33 | High-Q |
| 11 | CL03C3R9CA3GNN □ | | 3.9 pF | 25 | ±0.25 pF | 0.33 | High-Q |
| 12 | CL03C4R7CA3GNN □ | | 4.7 pF | 25 | ±0.25 pF | 0.33 | High-Q |
| 13 | CL03C5R6DA3GNN □ | | 5.6 pF | 25 | ±0.5 pF | 0.33 | High-Q |
| 14 | CL03C6R8DA3GNN □ | | 6.8 pF | 25 | ±0.5 pF | 0.33 | High-Q |
| 15 | CL03C8R2DA3GNN □ | | 8.2 pF | 25 | ±0.5 pF | 0.33 | High-Q |
| 16 | CL03C090DA3GNN □ | | 9.0 pF | 25 | ±0.5 pF | 0.33 | High-Q |
| 17 | CL03C100JA3GNN □ | | 10 pF | 25 | ±5% | 0.33 | High-Q |
| 18 | CL03C150JA3ANN □ | | 15 pF | 25 | ±5% | 0.33 | |
| 19 | CL03C180JA3ANN □ | | 18 pF | 25 | ±5% | 0.33 | |
| 20 | CL03C220JA3ANN □ | | 22 pF | 25 | ±5% | 0.33 | |
| 21 | CL03C270JA3ANN □ | | 27 pF | 25 | ±5% | 0.33 | |
| 22 | CL03C330JA3ANN □ | | 33 pF | 25 | ±5% | 0.33 | |
| 23 | CL03C390JA3ANN □ | | 39 pF | 25 | ±5% | 0.33 | |
| 24 | CL03C470JA3ANN □ | | 47 pF | 25 | ±5% | 0.33 | |
| 25 | CL03C101JB3ANN □ | | 100 pF | 50 | ±5% | 0.33 | |
| 26 | CL03C101JA3ANN □ | | 100 pF | 25 | ±5% | 0.33 | |

Part Numbering System

Standard & High Capacitors

Super Small Size Capacitors

High-Q Capacitors

Medium-High Voltage Capacitors

Array Type Capacitors

Low ESL Capacitors

Reliability Test Condition

Premium Capacitors for Automotive Applications

Packaging Specification

Application Manual for Surface Mounting

Product Lineup (Super Small Size Capacitors-X7R,X6S)

| | Part Number | Size L x W (mm) | Capacitance | Rated Voltage (Vdc) | Capacitance Tolerance | Thickness Max.(mm) | |
|----|------------------|-----------------|-------------|---------------------|-----------------------|--------------------|------|
| 1 | CL02B101KP2NNN □ | 0.40×0.20 | 100 pF | 10 | ±10% | 0.22 | |
| 2 | CL02B221KP2NNN □ | | 220 pF | 10 | ±10% | 0.22 | |
| 3 | CL02B271KP2NNN □ | | 270 pF | 10 | ±10% | 0.22 | |
| 4 | CL02B331KP2NNN □ | | 330 pF | 10 | ±10% | 0.22 | |
| 5 | CL02B391KP2NNN □ | | 390 pF | 10 | ±10% | 0.22 | |
| 6 | CL02B471KP2NNN □ | | 470 pF | 10 | ±10% | 0.22 | |
| 7 | CL02B681KP2NNN □ | | 680 pF | 10 | ±10% | 0.22 | |
| 8 | CL02B102KP2NNN □ | | 1 nF | 10 | ±10% | 0.22 | |
| 1 | CL03B151KA3NNN □ | 0.60×0.30 | 150 pF | 25 | ±10% | 0.33 | |
| 2 | CL03B221KA3NNN □ | | 220 pF | 25 | ±10% | 0.33 | |
| 3 | CL03B271KO3NNN □ | | 270 pF | 16 | ±10% | 0.33 | |
| 4 | CL03B331KA3NNN □ | | 330 pF | 25 | ±10% | 0.33 | |
| 5 | CL03B471KA3NNN □ | | 470 pF | 25 | ±10% | 0.33 | |
| 6 | CL03B561KO3NNN □ | | 560 pF | 16 | ±10% | 0.33 | |
| 7 | CL03B681KA3NNN □ | | 680 pF | 25 | ±10% | 0.33 | |
| 8 | CL03B821KO3NNN □ | | 820 pF | 16 | ±10% | 0.33 | |
| 9 | CL03B102KA3NNN □ | | 1 nF | 25 | ±10% | 0.33 | |
| 10 | CL03B152KP3NNN □ | | 1.5 nF | 10 | ±10% | 0.33 | |
| 11 | CL03B332KP3NNN □ | | 3.3 nF | 10 | ±10% | 0.33 | |
| 12 | CL03B392KP3NNN □ | | 3.9 nF | 10 | ±10% | 0.33 | |
| 13 | CL03B472KP3NNN □ | | 4.7 nF | 10 | ±10% | 0.33 | |
| 14 | CL03B682KP3NNN □ | | 6.8 nF | 10 | ±10% | 0.33 | |
| 15 | CL03B103KP3NNN □ | | 10 nF | 10 | ±10% | 0.33 | |
| 1 | CL03X104KQ3NNN □ | | | 100 nF | 6.3 | ±20% | 0.33 |
| 2 | CL03X105MR3CSN □ | | | 1 μF | 4 | ±20% | 0.35 |
| 3 | CL03X105MR3NRN □ | | | 1 μF | 4 | ±20% | 0.39 |

※ □ mark means packaging code. If you want to learn the code or quantity in detail, please see p74.



Product Lineup (Super Small Size Capacitors-X5R)

| | Part Number | Size L x W (mm) | Capacitance | Rated Voltage (Vdc) | Capacitance Tolerance | Thickness Max.(mm) |
|----|------------------|--------------------|-------------|---------------------------|--------------------------|-----------------------|
| 1 | CL02A151KQ2NNN □ | 0.40×0.20 | 150 pF | 6.3 | ±10% | 0.22 |
| 2 | CL02A221KQ2NNN □ | | 220 pF | 6.3 | ±10% | 0.22 |
| 3 | CL02A331KQ2NNN □ | | 330 pF | 6.3 | ±10% | 0.22 |
| 4 | CL02A471KQ2NNN □ | | 470 pF | 6.3 | ±10% | 0.22 |
| 5 | CL02A681KQ2NNN □ | | 680 pF | 6.3 | ±10% | 0.22 |
| 6 | CL02A102KQ2NNN □ | | 1 nF | 6.3 | ±10% | 0.22 |
| 7 | CL02A152KQ2NNN □ | | 1.5 nF | 6.3 | ±10% | 0.22 |
| 8 | CL02A222KQ2NNN □ | | 2.2 nF | 6.3 | ±10% | 0.22 |
| 9 | CL02A332KQ2NNN □ | | 3.2 nF | 6.3 | ±10% | 0.22 |
| 10 | CL02A472KQ2NNN □ | | 4.7 nF | 6.3 | ±10% | 0.22 |
| 11 | CL02A682KQ2NNN □ | | 6.8 nF | 6.3 | ±10% | 0.22 |
| 12 | CL02A103KQ2NNN □ | | 10 nF | 6.3 | ±10% | 0.22 |
| 13 | CL02A104KQ2NNN □ | | 100 nF | 6.3 | ±10% | 0.22 |
| 14 | CL02A224MR2NNN □ | | 220 nF | 4 | ±20% | 0.22 |
| 15 | CL02A224MQ2NNN □ | | 220 nF | 6.3 | ±20% | 0.22 |
| 1 | CL03A103KA3NNN □ | 0.60×0.30 | 10 nF | 25 | ±10% | 0.33 |
| 2 | CL03A223KQ3NNN □ | | 22 nF | 6.3 | ±10% | 0.33 |
| 3 | CL03A473KQ3NNN □ | | 47 nF | 6.3 | ±10% | 0.33 |
| 4 | CL03A104MA3NNN □ | | 100 nF | 25 | ±20% | 0.33 |
| 5 | CL03A104KO3NNN □ | | 100 nF | 16 | ±10% | 0.33 |
| 6 | CL03A104KP3NNN □ | | 100 nF | 10 | ±10% | 0.33 |
| 7 | CL03A104KQ3NNN □ | | 100 nF | 6.3 | ±10% | 0.33 |
| 8 | CL03A224KQ3NNN □ | | 220 nF | 6.3 | ±10% | 0.33 |
| 9 | CL03A224KP3NNN □ | | 220 nF | 10 | ±10% | 0.33 |
| 10 | CL03A105MO3NRR □ | | 1 nF | 16 | ±20% | 0.39 |
| 11 | CL03A105MQ3CSN □ | | 1 μF | 6.3 | ±20% | 0.35 |
| 12 | CL03A105MP3NSN □ | | 1 μF | 10 | ±20% | 0.35 |
| 13 | CL03A225MR3CRN □ | | 2.2 μF | 4 | ±20% | 0.39 |
| 14 | CL03A225MQ3CRN □ | | 2.2 μF | 6.3 | ±20% | 0.39 |

※ □ mark means packaging code. If you want to learn the code or quantity in detail, please see p74.



Feature

- High Q and low ESR in high frequency range
- Tight tolerance available
- High efficiency and low power consumption in RF circuit
- Can be applied to power amplifier module for base-station and GHz range communications

Application

- Base Station
- Set Top Box
- Wireless Equipment
- GPS, Bluetooth

Structure and Dimensions



| Code | EIA Code | Rated Voltage | Dimension (mm) | | | |
|------|----------|---------------|----------------|-----------|-----------|-----------------|
| | | | L | W | T | BW |
| 05 | 0402 | 50V | 1.00±0.05 | 0.50±0.05 | 0.50±0.05 | 0.25±0.10 |
| 10 | 0603 | 50/100V | 1.60±0.10 | 0.80±0.10 | 0.80±0.10 | 0.30±0.20 |
| | | 250V | 1.60±0.15 | 0.80±0.15 | 0.65±0.10 | 0.30±0.20 |
| 21 | 0805 | 250V | 2.00±0.15 | 1.25±0.15 | 0.85±0.15 | 0.50+0.20/-0.30 |

Capacitance Table (High-Q capacitor)

| TC | Size (mm) | Vr(V) | Capacitance (pF) | | | | | | | | | | | |
|-----|------------|-------|--|-----|---|----|----|----|----|----|----|-----|-----|-----|
| | | | 0.2 | 0.5 | 1 | 10 | 15 | 27 | 33 | 47 | 68 | 100 | 150 | 220 |
| COG | 0402(1005) | 50 | [Shaded area indicating capacitance range] | | | | | | | | | | | |
| | 0603(1608) | 50 | [Shaded area indicating capacitance range] | | | | | | | | | | | |
| | | 100 | [Shaded area indicating capacitance range] | | | | | | | | | | | |
| | | 250 | [Shaded area indicating capacitance range] | | | | | | | | | | | |
| | 0805(2012) | 250 | [Shaded area indicating capacitance range] | | | | | | | | | | | |

Part Numbering System

Standard & High Capacitors

Super Small Size Capacitors

High-Q Capacitors

Medium-High Voltage Capacitors

Array Type Capacitors

Low ESL Capacitors

Reliability Test Condition

Premium Capacitors for Automotive Applications

Packaging Specification

Application Manual for Surface Mounting

Medium-High Voltage Capacitors



Feature

- Highly reliable performance
- Operating at high voltage level
- Wide voltage level: from 100V to 3000V
- High withstanding voltage
- Tape & reel surface mount assembly

Application

- Switching Power Circuit(SMPS)
- Lighting Ballast, LCD back lighting inverter
- DC-DC converter input filter, snubber circuit
- Phone, Fax, Modem
- Network(IEEE802.3)

Structure and Dimensions



| Code | EIA Code | Dimension (mm) | | | | |
|------|----------|----------------|-----------|-----------|----------------|--------------|
| | | L | W | T | Thickness Code | BW |
| 10 | 0603 | 1.60±0.10 | 0.80±0.10 | 0.80±0.10 | 8 | 0.3±0.2 |
| 21 | 0805 | 2.00±0.10 | 1.25±0.10 | 1.25±0.10 | F | 0.5+0.2/-0.3 |
| | | 2.00±0.10 | 1.25±0.10 | 0.85±0.10 | C | |
| 31 | 1206 | 2.00±0.10 | 1.25±0.10 | 0.65±0.10 | A | 0.5±0.3 |
| | | 3.20±0.20 | 1.60±0.20 | 1.60±0.20 | H | |
| | | 3.20±0.15 | 1.60±0.15 | 1.25±0.15 | F | |
| 32 | 1210 | 3.20±0.15 | 1.60±0.15 | 0.85±0.15 | C | 0.6±0.3 |
| | | 3.20±0.30 | 2.50±0.20 | 2.50±0.20 | J | |
| | | 3.20±0.30 | 2.50±0.20 | 1.60±0.20 | H | |
| 42 | 1808 | 3.20±0.30 | 2.50±0.20 | 1.25±0.20 | F | 0.8±0.3 |
| | | 4.50±0.40 | 2.00±0.20 | 2.00±0.20 | I | |
| | | 4.50±0.40 | 2.00±0.20 | 1.60±0.20 | H | |
| 43 | 1812 | 4.50±0.40 | 2.00±0.20 | 1.25±0.20 | F | 0.8±0.3 |
| | | 4.50±0.40 | 3.20±0.30 | 2.50±0.20 | J | |
| | | 4.50±0.40 | 3.20±0.30 | 1.60±0.20 | H | |
| 55 | 2220 | 4.50±0.40 | 3.20±0.30 | 1.25±0.20 | F | 1.0±0.3 |
| | | 5.70±0.40 | 5.00±0.40 | 2.50±0.20 | J | |
| | | 5.70±0.40 | 5.00±0.40 | 1.60±0.20 | H | |

Medium-High Voltage capacitance Table (C0G)

| Vr(V) | Size(mm) | Capacitance | | | | | | | | | | | | | | | | | | | | | | | | | |
|-------|------------|-------------|-----|-----|-----|-----|-----|------|-----|-----|-----|-----|-----|-----|-----|-----|-----|-----|-----|----|----|----|----|----|----|----|----|
| | | (pF) | | | | | | (nF) | | | | | | | | | | | | | | | | | | | |
| | | 330 | 390 | 470 | 560 | 680 | 820 | 1 | 1.2 | 1.5 | 1.8 | 2.2 | 2.7 | 3.3 | 3.9 | 4.7 | 5.6 | 6.8 | 8.2 | 10 | 12 | 15 | 18 | 22 | 27 | 33 | 47 |
| 100V | 0603(1608) | ■ | | | | | | | | | | | | | | | | | | | | | | | | | |
| | 0805(2012) | ■ | | | | | | | | | | | | | | | | | | | | | | | | | |
| | 1206(3216) | ■ | | | | | | | | | | | | | | | | | | | | | | | | | |
| | 1210(3225) | | | | | | | | | | | | | | | | | | | ■ | | | | | | | |
| | 1812(4532) | | | | | | | | | | | | | | | | | | | ■ | | | | | | | |
| | 2220(5750) | | | | | | | | | | | | | | | | | | | ■ | | | | | | | |
| 200V | 0603(1608) | ■ | | | | | | | | | | | | | | | | | | | | | | | | | |
| | 0805(2012) | ■ | | | | | | | | | | | | | | | | | | | | | | | | | |
| | 1206(3216) | ■ | | | | | | | | | | | | | | | | | | | | | | | | | |
| | 1210(3225) | | | | | | | | | | | | | | | | | | | ■ | | | | | | | |
| | 1812(4532) | | | | | | | | | | | | | | | | | | | ■ | | | | | | | |
| | 2220(5750) | | | | | | | | | | | | | | | | | | | ■ | | | | | | | |
| 250V | 0603(1608) | ■ | | | | | | | | | | | | | | | | | | | | | | | | | |
| | 0805(2012) | ■ | | | | | | | | | | | | | | | | | | | | | | | | | |
| | 1206(3216) | ■ | | | | | | | | | | | | | | | | | | | | | | | | | |
| | 1210(3225) | | | | | | | | | | | | | | | | | | | ■ | | | | | | | |
| | 1812(4532) | | | | | | | | | | | | | | | | | | | ■ | | | | | | | |
| | 2220(5750) | | | | | | | | | | | | | | | | | | | ■ | | | | | | | |
| 500V | 1206(3216) | ■ | | | | | | | | | | | | | | | | | | | | | | | | | |
| | 1210(3225) | ■ | | | | | | | | | | | | | | | | | | | | | | | | | |
| | 1812(4532) | ■ | | | | | | | | | | | | | | | | | | | | | | | | | |
| | 2220(5750) | | | | | | | | | | | | | | | | | | | ■ | | | | | | | |
| 630V | 0805(2012) | ■ | | | | | | | | | | | | | | | | | | | | | | | | | |
| | 1206(3216) | ■ | | | | | | | | | | | | | | | | | | | | | | | | | |
| | 1210(3225) | ■ | | | | | | | | | | | | | | | | | | | | | | | | | |
| | 1812(4532) | ■ | | | | | | | | | | | | | | | | | | | | | | | | | |
| | 2220(5750) | | | | | | | | | | | | | | | | | | | ■ | | | | | | | |

- Part Numbering System
- Standard & High Capacitors
- Super Small Size Capacitors
- High-Q Capacitors
- Medium-High Voltage Capacitors
- Array Type Capacitors
- Low ESL Capacitors
- Reliability Test Condition
- Premium Capacitors for Automotive Applications
- Packaging Specification
- Application Manual for Surface Mounting



Medium-High Voltage capacitance Table (COG)

| Vr(V) | Size(mm) | Capacitance | | | | | | | | | | | | | | | | | | | | | | | |
|-------|------------|---------------------------|----|----|----|-----|-----|-----|-----|-----|-----|-----|-----|-----|-----|-----|-----------------|---|-----|-----|-----|-----|-----|-----|-----|
| | | (pF) | | | | | | | | | | | | | | | (nF) | | | | | | | | |
| | | 47 | 56 | 68 | 82 | 100 | 120 | 150 | 180 | 220 | 270 | 330 | 390 | 470 | 560 | 680 | 820 | 1 | 1.2 | 1.5 | 1.8 | 2.2 | 2.7 | 3.3 | 3.9 |
| 1KV | 1206(3216) | [Bar from 47 to 470 pF] | | | | | | | | | | | | | | | | | | | | | | | |
| | 1210(3225) | [Bar from 330 to 820 pF] | | | | | | | | | | | | | | | | | | | | | | | |
| | 1812(4532) | [Bar from 470 to 1800 pF] | | | | | | | | | | | | | | | | | | | | | | | |
| | 2220(5750) | | | | | | | | | | | | | | | | [Bar at 3.6 nF] | | | | | | | | |
| 2KV | 1206(3216) | [Bar from 47 to 120 pF] | | | | | | | | | | | | | | | | | | | | | | | |
| | 1210(3225) | [Bar from 47 to 470 pF] | | | | | | | | | | | | | | | | | | | | | | | |
| | 1808(4520) | [Bar from 47 to 270 pF] | | | | | | | | | | | | | | | | | | | | | | | |
| | 1812(4532) | [Bar from 47 to 1800 pF] | | | | | | | | | | | | | | | | | | | | | | | |
| | 2220(5750) | [Bar from 470 to 820 pF] | | | | | | | | | | | | | | | | | | | | | | | |
| 3KV | 1808(4520) | [Bar from 47 to 150 pF] | | | | | | | | | | | | | | | | | | | | | | | |
| | 1812(4532) | [Bar from 120 to 390 pF] | | | | | | | | | | | | | | | | | | | | | | | |
| | 2220(5750) | [Bar from 470 to 820 pF] | | | | | | | | | | | | | | | | | | | | | | | |

Medium-High Voltage capacitance Table (X7R)

| Vr(V) | Size(mm) | Capacitance (nF) | | | | | | | | | | | | | | | |
|-------|------------|--|----|----|----|----|----|----|-----|-----|-----|-----|-----|-----|------|------|------|
| | | 4.7 | 10 | 15 | 22 | 33 | 47 | 68 | 100 | 150 | 220 | 330 | 470 | 680 | 1000 | 1500 | 2200 |
| 100V | 0603(1608) | [Bar chart showing capacitance range for 0603(1608) at 100V] | | | | | | | | | | | | | | | |
| | 0805(2012) | [Bar chart showing capacitance range for 0805(2012) at 100V] | | | | | | | | | | | | | | | |
| | 1206(3216) | [Bar chart showing capacitance range for 1206(3216) at 100V] | | | | | | | | | | | | | | | |
| | 1210(3225) | [Bar chart showing capacitance range for 1210(3225) at 100V] | | | | | | | | | | | | | | | |
| | 1812(4532) | [Bar chart showing capacitance range for 1812(4532) at 100V] | | | | | | | | | | | | | | | |
| | 2220(5750) | [Bar chart showing capacitance range for 2220(5750) at 100V] | | | | | | | | | | | | | | | |
| 200V | 0805(2012) | [Bar chart showing capacitance range for 0805(2012) at 200V] | | | | | | | | | | | | | | | |
| | 1206(3216) | [Bar chart showing capacitance range for 1206(3216) at 200V] | | | | | | | | | | | | | | | |
| | 1210(3225) | [Bar chart showing capacitance range for 1210(3225) at 200V] | | | | | | | | | | | | | | | |
| | 1812(4532) | [Bar chart showing capacitance range for 1812(4532) at 200V] | | | | | | | | | | | | | | | |
| | 2220(5750) | [Bar chart showing capacitance range for 2220(5750) at 200V] | | | | | | | | | | | | | | | |
| 250V | 0805(2012) | [Bar chart showing capacitance range for 0805(2012) at 250V] | | | | | | | | | | | | | | | |
| | 1206(3216) | [Bar chart showing capacitance range for 1206(3216) at 250V] | | | | | | | | | | | | | | | |
| | 1210(3225) | [Bar chart showing capacitance range for 1210(3225) at 250V] | | | | | | | | | | | | | | | |
| | 1812(4532) | [Bar chart showing capacitance range for 1812(4532) at 250V] | | | | | | | | | | | | | | | |
| | 2220(5750) | [Bar chart showing capacitance range for 2220(5750) at 250V] | | | | | | | | | | | | | | | |
| 350V | 1206(3216) | (Tmax=1.0) (Tmax (Tmax =1.25)=1.8) | | | | | | | | | | | | | | | |
| 500V | 1206(3216) | [Bar chart showing capacitance range for 1206(3216) at 500V] | | | | | | | | | | | | | | | |
| | 1210(3225) | [Bar chart showing capacitance range for 1210(3225) at 500V] | | | | | | | | | | | | | | | |
| | 1812(4532) | [Bar chart showing capacitance range for 1812(4532) at 500V] | | | | | | | | | | | | | | | |
| | 2220(5750) | [Bar chart showing capacitance range for 2220(5750) at 500V] | | | | | | | | | | | | | | | |
| 630V | 1206(3216) | [Bar chart showing capacitance range for 1206(3216) at 630V] | | | | | | | | | | | | | | | |
| | 1210(3225) | [Bar chart showing capacitance range for 1210(3225) at 630V] | | | | | | | | | | | | | | | |
| | 1812(4532) | [Bar chart showing capacitance range for 1812(4532) at 630V] | | | | | | | | | | | | | | | |
| | 2220(5750) | [Bar chart showing capacitance range for 2220(5750) at 630V] | | | | | | | | | | | | | | | |

- Part Numbering System
- Standard & High Capacitors
- Super Small Size Capacitors
- High-Q Capacitors
- Medium-High Voltage Capacitors
- Array Type Capacitors
- Low ESL Capacitors
- Reliability Test Condition
- Premium Capacitors for Automotive Applications
- Packaging Specification
- Application Manual for Surface Mounting

Product Lineup (Medium-High Voltage Capacitors-C0G)

| | Part Number | Size L x W (mm) | Capacitance | Rated Voltage (Vdc) | Capacitance Tolerance | Thickness Max.(mm) |
|----|------------------|-----------------|-------------|---------------------|-----------------------|--------------------|
| 1 | CL10C100JC8NNN □ | 1.60×0.80 | 10 pF | 100 | ±5% | 0.90 |
| 2 | CL10C150JC8NNN □ | | 15 pF | 100 | ±5% | 0.90 |
| 3 | CL10C330JC8NNN □ | | 33 pF | 100 | ±5% | 0.90 |
| 4 | CL10C390JC8NNN □ | | 39 pF | 100 | ±5% | 0.90 |
| 5 | CL10C470JC8NNN □ | | 47 pF | 100 | ±5% | 0.90 |
| 6 | CL10C560JC8NNN □ | | 56 pF | 100 | ±5% | 0.90 |
| 7 | CL10C101JC8NNN □ | | 100 pF | 100 | ±5% | 0.90 |
| 8 | CL10C121JC8NNN □ | | 120 pF | 100 | ±5% | 0.90 |
| 9 | CL10C151JC8NNN □ | | 150 pF | 100 | ±5% | 0.90 |
| 10 | CL10C331JC8NNN □ | | 330 pF | 100 | ±5% | 0.90 |
| 11 | CL10C331JD8NNN □ | | 330 pF | 200 | ±5% | 0.90 |
| 12 | CL10C331JE8NNN □ | | 330 pF | 250 | ±5% | 0.90 |
| 13 | CL10C391JD8NNN □ | | 390 pF | 200 | ±5% | 0.90 |
| 14 | CL10C391JE8NNN □ | | 390 pF | 250 | ±5% | 0.90 |
| 15 | CL10C471JC8NNN □ | | 470 pF | 100 | ±5% | 0.90 |
| 16 | CL10C471JD8NNN □ | | 470 pF | 200 | ±5% | 0.90 |
| 17 | CL10C471JE8NNN □ | | 470 pF | 250 | ±5% | 0.90 |
| 18 | CL10C561JD8NNN □ | | 560 pF | 200 | ±5% | 0.90 |
| 19 | CL10C561JE8NNN □ | | 560 pF | 250 | ±5% | 0.90 |
| 20 | CL10C681JC8NNN □ | | 680 pF | 100 | ±5% | 0.90 |
| 21 | CL10C681JD8NNN □ | | 680 pF | 200 | ±5% | 0.90 |
| 22 | CL10C681JE8NNN □ | | 680 pF | 250 | ±5% | 0.90 |
| 23 | CL10C821JC8NNN □ | | 820 pF | 100 | ±5% | 0.90 |
| 24 | CL10C102JC8NNN □ | | 1 nF | 100 | ±5% | 0.90 |
| 25 | CL10C122JC8NNN □ | | 1.2 nF | 100 | ±5% | 0.90 |
| 1 | CL21C100JCANNN □ | 2.00×1.25 | 10 pF | 100 | ±5% | 0.75 |
| 2 | CL21C120JCANNN □ | | 12 pF | 100 | ±5% | 0.75 |
| 3 | CL21C150JCANNN □ | | 15 pF | 100 | ±5% | 0.75 |
| 4 | CL21C150JDCNNN □ | | 15 pF | 200 | ±5% | 0.95 |
| 5 | CL21C180JCANNN □ | | 18 pF | 100 | ±5% | 0.75 |
| 6 | CL21C180JDCNNN □ | | 18 pF | 200 | ±5% | 0.95 |
| 7 | CL21C220JCANNN □ | | 22 pF | 100 | ±5% | 0.75 |
| 8 | CL21C270JCANNN □ | | 27 pF | 100 | ±5% | 0.75 |
| 9 | CL21C270JHFNNN □ | | 27 pF | 630 | ±5% | 1.35 |
| 10 | CL21C330JCANNN □ | | 33 pF | 100 | ±5% | 0.75 |
| 11 | CL21C330JDCNNN □ | | 33 pF | 200 | ±5% | 0.95 |
| 12 | CL21C330JHFNNN □ | | 33 pF | 630 | ±5% | 1.35 |
| 13 | CL21C390JDCNNN □ | | 39 pF | 200 | ±5% | 0.95 |
| 14 | CL21C470JCANNN □ | | 47 pF | 100 | ±5% | 0.75 |
| 15 | CL21C470JDCNNN □ | | 47 pF | 200 | ±5% | 0.95 |
| 16 | CL21C470JHFNNN □ | | 47 pF | 630 | ±5% | 1.35 |
| 17 | CL21C560JCCNNN □ | | 56 pF | 100 | ±5% | 0.95 |
| 18 | CL21C560JDCNNN □ | | 56 pF | 200 | ±5% | 0.95 |
| 19 | CL21C680JCANNN □ | | 68 pF | 100 | ±5% | 0.75 |
| 20 | CL21C680JDCNNN □ | | 68 pF | 200 | ±5% | 0.95 |
| 21 | CL21C680JHFNNN □ | | 68 pF | 630 | ±5% | 1.35 |
| 22 | CL21C820JCCNNN □ | | 82 pF | 100 | ±5% | 0.95 |
| 23 | CL21C101JCANNN □ | | 100 pF | 100 | ±5% | 0.75 |
| 24 | CL21C101JDCNNN □ | | 100 pF | 200 | ±5% | 0.95 |
| 25 | CL21C101JECNNN □ | | 100 pF | 250 | ±5% | 0.95 |

※ □ mark means packaging code. If you want to learn the code or quantity in detail, please see p74.

Part Numbering System

Standard & High Capacitors

Super Small Size Capacitors

High-Q Capacitors

Medium-High Voltage Capacitors

Array Type Capacitors

Low ESL Capacitors

Reliability Test Condition

Premium Capacitors for Automotive Applications

Packaging Specification

Application Manual for Surface Mounting



Product Lineup (Medium-High Voltage Capacitors-C0G)

| | Part Number | Size L x W (mm) | Capacitance | Rated Voltage (Vdc) | Capacitance Tolerance | Thickness Max.(mm) |
|----|------------------|-----------------|-------------|---------------------|-----------------------|--------------------|
| 26 | CL21C121JDCNNN □ | 2.00×1.25 | 120pF | 200 | ±5% | 0.95 |
| 27 | CL21C151JCANNN □ | | 150pF | 100 | ±5% | 0.75 |
| 28 | CL21C151JHFNNN □ | | 150pF | 630 | ±5% | 1.35 |
| 29 | CL21C221JCANNN □ | | 220pF | 100 | ±5% | 0.75 |
| 30 | CL21C221JDCNNN □ | | 220pF | 200 | ±5% | 0.95 |
| 31 | CL21C331JCANNN □ | | 330pF | 100 | ±5% | 0.75 |
| 32 | CL21C471JCCNNN □ | | 470pF | 100 | ±5% | 0.95 |
| 33 | CL21C561JCCNNN □ | | 560pF | 100 | ±5% | 0.95 |
| 34 | CL21C561JHFNNN □ | | 560pF | 630 | ±5% | 1.35 |
| 35 | CL21C681JCCNNN □ | | 680pF | 100 | ±5% | 0.95 |
| 36 | CL21C102JCFNNN □ | | 1nF | 100 | ±5% | 1.35 |
| 37 | CL21C102JDFNNN □ | | 1nF | 200 | ±5% | 1.35 |
| 38 | CL21C272JDFNNN □ | | 2.7nF | 200 | ±5% | 1.35 |
| 39 | CL21C272JEFNNN □ | | 2.7nF | 250 | ±5% | 1.35 |
| 40 | CL21C472JCFNNN □ | | 4.7nF | 100 | ±5% | 1.35 |
| 1 | CL31C150JGFNNN □ | | 3.20×1.60 | 15pF | 500 | ±5% |
| 2 | CL31C180JGFNNN □ | 18pF | | 500 | ±5% | 1.40 |
| 3 | CL31C220JGFNNN □ | 22pF | | 500 | ±5% | 1.40 |
| 4 | CL31C220JJHNNN □ | 22pF | | 2000 | ±5% | 1.80 |
| 5 | CL31C270JGFNNN □ | 27pF | | 500 | ±5% | 1.40 |
| 6 | CL31C330JGFNNN □ | 33pF | | 500 | ±5% | 1.40 |
| 7 | CL31C390JGFNNN □ | 39pF | | 500 | ±5% | 1.40 |
| 8 | CL31C470JGFNNN □ | 47pF | | 500 | ±5% | 1.40 |
| 9 | CL31C470JHFNNN □ | 47pF | | 630 | ±5% | 1.40 |
| 10 | CL31C470JIFNNN □ | 47μF | | 1000 | ±5% | 1.40 |
| 11 | CL31C470JJHNNN □ | 47pF | | 2000 | ±5% | 1.80 |
| 12 | CL31C560JGFNNN □ | 56pF | | 500 | ±5% | 1.40 |
| 13 | CL31C680JCCNNN □ | 68pF | | 100 | ±5% | 1.00 |
| 14 | CL31C680JGFNNN □ | 68pF | | 500 | ±5% | 1.40 |
| 15 | CL31C680JHFNNN □ | 68pF | | 630 | ±5% | 1.40 |
| 16 | CL31C680JIFNNN □ | 68pF | | 1000 | ±5% | 1.40 |
| 17 | CL31C820JGFNCN □ | 82pF | | 500 | ±5% | 1.40 |
| 18 | CL31C101JGFNNN □ | 100pF | | 500 | ±5% | 1.40 |
| 19 | CL31C101JHFNNN □ | 100pF | | 630 | ±5% | 1.40 |
| 20 | CL31C101JIFNNN □ | 100pF | | 1000 | ±5% | 1.40 |
| 21 | CL31C101JJHNNN □ | 100pF | | 2000 | ±5% | 1.80 |
| 22 | CL31C121JGFNNN □ | 120pF | | 500 | ±5% | 1.40 |
| 23 | CL31C151JGFNNN □ | 150pF | | 500 | ±5% | 1.40 |
| 24 | CL31C181JGFNNN □ | 180pF | | 500 | ±5% | 1.40 |
| 25 | CL31C221JGFNNN □ | 220pF | | 500 | ±5% | 1.40 |
| 26 | CL31C271JGFNNN □ | 270pF | | 500 | ±5% | 1.40 |
| 27 | CL31C271JCCNNN □ | 270pF | | 100 | ±5% | 1.00 |
| 28 | CL31C331JGFNNN □ | 330pF | | 500 | ±5% | 1.40 |
| 29 | CL31C331JJHNNN □ | 330pF | | 1000 | ±5% | 1.80 |
| 30 | CL31C391JCCNNN □ | 390pF | | 100 | ±5% | 1.00 |
| 31 | CL31C471JGFNNN □ | 470pF | | 500 | ±5% | 1.40 |
| 32 | CL31C471JHFNNN □ | 470pF | | 630 | ±5% | 1.40 |
| 33 | CL31C471JIFNNN □ | 470pF | | 1000 | ±5% | 1.40 |
| 34 | CL31C561JCCNNN □ | 560pF | | 100 | ±5% | 1.00 |
| 35 | CL31C561JGFNNN □ | 560pF | | 500 | ±5% | 1.40 |
| 36 | CL31C681JGFNNN □ | 680pF | | 500 | ±5% | 1.80 |
| 37 | CL31C821JJHNNN □ | 820pF | | 630 | 5% | 1.80 |

※ □ mark means packaging code. If you want to learn the code or quantity in detail, please see p74.

Product Lineup (Medium-High Voltage Capacitors-C0G)

| | Part Number | Size L x W (mm) | Capacitance | Rated Voltage (Vdc) | Capacitance Tolerance | Thickness Max.(mm) | |
|----|------------------|-----------------|-------------|---------------------|-----------------------|--------------------|------|
| 36 | CL31C102JCCNNN □ | 3.20×1.60 | 1nF | 100 | ±5% | 1.00 | |
| 37 | CL31C102JGHNNN □ | | 1nF | 500 | ±5% | 1.80 | |
| 38 | CL31C152JCCNNN □ | | 1.5nF | 100 | ±5% | 1.00 | |
| 39 | CL31C222JCCNNN □ | | 2.2nF | 100 | ±5% | 1.00 | |
| 40 | CL31C332JGHNNN □ | | 3.3nF | 500 | ±5% | 1.80 | |
| 41 | CL31C332JHHNNN □ | | 3.3nF | 630 | ±5% | 1.80 | |
| 42 | CL31C392JCHNNN □ | | 3.9nF | 100 | ±5% | 1.80 | |
| 43 | CL31C822JDHNNN □ | | 8.2nF | 200 | ±5% | 1.80 | |
| 44 | CL31C822JEHNNN □ | | 8.2nF | 250 | ±5% | 1.80 | |
| 45 | CL31C183JCHNNN □ | | 18nF | 100 | ±5% | 1.80 | |
| 1 | CL32C101JFFNNN □ | | 3.20×2.50 | 100pF | 2000 | ±5% | 1.45 |
| 2 | CL32C471JJJNNN □ | | | 470pF | 2000 | ±5% | 2.70 |
| 3 | CL32C821JIJNNN □ | 820pF | | 1000 | ±5% | 2.70 | |
| 4 | CL32C103JGJNNN □ | 10nF | | 500 | ±5% | 2.70 | |
| 5 | CL32C103JHJNNN □ | 10nF | | 630 | ±5% | 2.70 | |
| 6 | CL32C273JDJNNN □ | 27nF | | 200 | ±5% | 2.70 | |
| 7 | CL32C273JEJNNN □ | 27nF | | 250 | ±5% | 2.70 | |
| 8 | CL32C563JCJNNN □ | 56nF | | 100 | ±5% | 2.70 | |
| 1 | CL42C100JKFNNN □ | 4.50×2.00 | 10pF | 3000 | ±5% | 1.45 | |
| 2 | CL42C151JKINNN □ | | 150pF | 3000 | ±5% | 2.20 | |
| 3 | CL42C221JJHNNN □ | | 220pF | 2000 | ±5% | 1.80 | |
| 1 | CL43C391JKJNNN □ | 4.50×3.20 | 390pF | 3000 | ±5% | 2.70 | |
| 2 | CL43C102JIHNNN □ | | 1nF | 1000 | ±5% | 1.80 | |
| 3 | CL43C122JIINNN □ | | 1.2nF | 1000 | ±5% | 2.20 | |
| 4 | CL43C182JIJNNN □ | | 1.8nF | 1000 | ±5% | 2.70 | |
| 5 | CL43C182JJJNNN □ | | 1.8nF | 2000 | ±5% | 2.70 | |
| 6 | CL43C223JGJNNN □ | | 22nF | 500 | ±5% | 2.70 | |
| 7 | CL43C223JHJNNN □ | | 22nF | 630 | ±5% | 2.70 | |
| 8 | CL43C473JDJNNN □ | | 47nF | 200 | ±5% | 2.70 | |
| 9 | CL43C473JEJNNN □ | | 47nF | 250 | ±5% | 2.70 | |
| 10 | CL43C563JCJNNN □ | | 56nF | 100 | ±5% | 2.70 | |
| 1 | CL55C102JJJNNN □ | 5.70×5.00 | 1nF | 2000 | ±5% | 2.70 | |
| 2 | CL55C102JKJNNN □ | | 1nF | 3000 | ±5% | 2.70 | |
| 3 | CL55C362JIJNNN □ | | 3.6nF | 1000 | ±5% | 2.70 | |
| 4 | CL55C223JGJNNN □ | | 22nF | 500 | ±5% | 2.70 | |
| 5 | CL55C223JHJNNN □ | | 22nF | 630 | ±5% | 2.70 | |
| 6 | CL55C473JDJNNN □ | | 47nF | 200 | ±5% | 2.70 | |
| 7 | CL55C473JEJNNN □ | | 47nF | 250 | ±5% | 2.70 | |
| 8 | CL55C683JCJNNN □ | | 68nF | 100 | ±5% | 2.70 | |

※ □ mark means packaging code. If you want to learn the code or quantity in detail, please see p74.

- Part Numbering System
- Standard & High Capacitors
- Super Small Size Capacitors
- High-Q Capacitors
- Medium-High Voltage Capacitors
- Array Type Capacitors
- Low ESL Capacitors
- Reliability Test Condition
- Premium Capacitors for Automotive Applications
- Packaging Specification
- Application Manual for Surface Mounting



Product Lineup (Medium-High Voltage Capacitors-X7R)

| | Part Number | Size L x W (mm) | Capacitance | Rated Voltage (Vdc) | Capacitance Tolerance | Thickness Max.(mm) |
|----|------------------|-----------------|-------------|---------------------|-----------------------|--------------------|
| 1 | CL10B102KC8NNN □ | 1.60 x 0.80 | 1nF | 100 | ±10% | 0.90 |
| 2 | CL10B472KC8NNN □ | | 4.7nF | 100 | ±10% | 0.90 |
| 3 | CL10B103KC8NNN □ | | 10nF | 100 | ±10% | 0.90 |
| 4 | CL10B104KC8NNN □ | | 100nF | 100 | ±10% | 0.90 |
| 1 | CL21B221KDCNNN □ | 2.00×1.25 | 220pF | 200 | ±10% | 0.95 |
| 2 | CL21B221KCANNN □ | | 220pF | 100 | ±10% | 0.75 |
| 3 | CL21B331KDCNNN □ | | 330pF | 200 | ±10% | 0.95 |
| 4 | CL21B471KCANNN □ | | 470pF | 100 | ±10% | 0.75 |
| 5 | CL21B102KDCNNN □ | | 1nF | 200 | ±10% | 0.95 |
| 6 | CL21B102KCANNN □ | | 1nF | 100 | ±10% | 0.75 |
| 7 | CL21B222KDCNNN □ | | 2.2nF | 200 | ±10% | 0.95 |
| 8 | CL21B222KCANNN □ | | 2.2nF | 100 | ±10% | 0.75 |
| 9 | CL21B332KCANNN □ | | 3.3nF | 100 | ±10% | 0.75 |
| 10 | CL21B472KDCNNN □ | | 4.7nF | 200 | ±10% | 0.95 |
| 11 | CL21B472KCANNN □ | | 4.7nF | 100 | ±10% | 0.75 |
| 12 | CL21B682KCANNN □ | | 6.8nF | 100 | ±10% | 0.75 |
| 13 | CL21B103KDCNNN □ | | 10nF | 200 | ±10% | 0.95 |
| 14 | CL21B103KCANNN □ | | 10nF | 100 | ±10% | 0.75 |
| 15 | CL21B153KEFNNN □ | | 15nF | 250 | ±10% | 1.35 |
| 16 | CL21B153KDFNNN □ | | 15nF | 200 | ±10% | 1.35 |
| 17 | CL21B153KCCNNN □ | | 15nF | 100 | ±10% | 0.95 |
| 18 | CL21B223KCFNNN □ | | 22nF | 100 | ±10% | 1.35 |
| 19 | CL21B473KCFNNN □ | | 47nF | 100 | ±10% | 1.35 |
| 20 | CL21B683KCFNNN □ | | 68nF | 100 | ±10% | 1.35 |
| 21 | CL21B154KCFNNN □ | | 150nF | 100 | ±10% | 1.35 |
| 22 | CL21B224KCFNNN □ | | 220nF | 100 | ±10% | 1.35 |
| 1 | CL31B221KGFNNN □ | 3.20×1.60 | 220pF | 500 | ±10% | 1.40 |
| 2 | CL31B471KGFNNN □ | | 470pF | 500 | ±10% | 1.40 |
| 3 | CL31B471KDCNNN □ | | 470pF | 200 | ±10% | 1.00 |
| 4 | CL31B102KJHNNN □ | | 1nF | 2000 | ±10% | 1.80 |
| 5 | CL31B102KIFNNN □ | | 1nF | 1000 | ±10% | 1.40 |
| 6 | CL31B102KGFNNN □ | | 1nF | 500 | ±10% | 1.40 |
| 7 | CL31B102KHFNNN □ | | 1nF | 630 | ±10% | 1.40 |
| 8 | CL31B152KGFNNN □ | | 1.5nF | 500 | ±10% | 1.40 |
| 9 | CL31B152KJHNNN □ | | 1.5nF | 2000 | ±10% | 1.80 |
| 10 | CL31B222KIFNNN □ | | 2.2nF | 1000 | ±10% | 1.40 |
| 11 | CL31B222KDCNNN □ | | 2.2nF | 200 | ±10% | 1.00 |
| 12 | CL31B222KGFNNN □ | | 2.2nF | 500 | ±10% | 1.40 |
| 13 | CL31B222KJHNNN □ | | 2.2nF | 2000 | ±10% | 1.80 |
| 14 | CL31B332KGFNNN □ | | 3.3nF | 500 | ±10% | 1.40 |
| 15 | CL31B332KIFNNN □ | | 3.3nF | 1000 | ±10% | 1.40 |
| 16 | CL31B472KGFNNN □ | | 4.7nF | 500 | ±10% | 1.40 |

※ □ mark means packaging code. If you want to learn the code or quantity in detail, please see p74.

Product Lineup (Medium-High Voltage Capacitors-X7R)

| | Part Number | Size L x W (mm) | Capacitance | Rated Voltage (Vdc) | Capacitance Tolerance | Thickness Max.(mm) | |
|----|------------------|-----------------|-------------|---------------------|-----------------------|--------------------|------|
| 17 | CL31B472KDCNNN □ | 3.20×1.60 | 4.7nF | 200 | ±10% | 1.00 | |
| 18 | CL31B682KGFNNN □ | | 6.8nF | 500 | ±10% | 1.40 | |
| 19 | CL31B103KHFNNN □ | | 10nF | 630 | ±10% | 1.40 | |
| 20 | CL31B103KGFNNN □ | | 10nF | 500 | ±10% | 1.40 | |
| 21 | CL31B103KFCSNN □ | | 10nF | 350 | ±10% | 1.00 | |
| 22 | CL31B153KDCNNN □ | | 15nF | 200 | ±10% | 1.00 | |
| 23 | CL31B153KFCSNN □ | | 15nF | 350 | ±10% | 1.00 | |
| 24 | CL31B153KCCNNN □ | | 15nF | 100 | ±10% | 1.00 | |
| 25 | CL31B153KGFNNN □ | | 15nF | 500 | ±10% | 1.40 | |
| 26 | CL31B153KHFNNN □ | | 15nF | 630 | ±10% | 1.40 | |
| 27 | CL31B223KDCNNN □ | | 22nF | 200 | ±10% | 1.00 | |
| 28 | CL31B223KCCNNN □ | | 22nF | 100 | ±10% | 1.00 | |
| 29 | CL31B223KFCSNN □ | | 22nF | 350 | ±10% | 1.00 | |
| 30 | CL31B223KGHNNN □ | | 22nF | 500 | ±10% | 1.80 | |
| 31 | CL31B223KHHNNN □ | | 22nF | 630 | ±10% | 1.80 | |
| 32 | CL31B333KDFNNN □ | | 33nF | 200 | ±10% | 1.40 | |
| 33 | CL31B333KFESNN □ | | 33nF | 350 | ±10% | 1.25 | |
| 34 | CL31B333KCCNNN □ | | 33nF | 100 | ±10% | 1.00 | |
| 35 | CL31B333KGHNNN □ | | 33nF | 500 | ±10% | 1.80 | |
| 36 | CL31B333KHHNNN □ | | 33nF | 630 | ±10% | 1.80 | |
| 37 | CL31B473KDFNNN □ | | 47nF | 200 | ±10% | 1.40 | |
| 38 | CL31B473KFHSNN □ | | 47nF | 350 | ±10% | 1.80 | |
| 39 | CL31B473KCCNNN □ | | 47nF | 100 | ±10% | 1.00 | |
| 40 | CL31B473KEHNNN □ | | 47nF | 250 | ±10% | 1.80 | |
| 41 | CL31B683KEHNNN □ | | 68nF | 250 | ±10% | 1.80 | |
| 42 | CL31B104KDHNNN □ | | 100nF | 200 | ±10% | 1.80 | |
| 43 | CL31B104KCFNNN □ | | 100nF | 100 | ±10% | 1.40 | |
| 44 | CL31B104KEHNNN □ | | 100nF | 250 | ±10% | 1.80 | |
| 45 | CL31B154KCHNNN □ | | 150nF | 100 | ±10% | 1.80 | |
| 46 | CL31B105KCHNNN □ | | 1μF | 100 | ±10% | 1.80 | |
| 47 | CL31B155KCHNNN □ | | 1.5μF | 100 | ±10% | 1.80 | |
| 48 | CL31B225KCHNNN □ | | 2.2μF | 100 | ±10% | 1.80 | |
| 1 | CL32B102KJFNNN □ | | 3.20×2.50 | 1nF | 2000 | ±10% | 1.45 |
| 2 | CL32B472KHFNNN □ | | | 4.7nF | 630 | ±10% | 1.45 |
| 3 | CL32B472KIFNNN □ | | | 4.7nF | 1000 | ±10% | 1.45 |
| 4 | CL32B682KIFNNN □ | | | 6.8nF | 1000 | ±10% | 1.45 |
| 5 | CL32B103KCFNNN □ | | | 10nF | 100 | ±10% | 1.45 |
| 6 | CL32B153KGFNNN □ | | | 15nF | 500 | ±10% | 1.45 |
| 7 | CL32B223KGFNNN □ | | | 22nF | 500 | ±10% | 1.45 |
| 8 | CL32B333KHHNNN □ | | | 33nF | 630 | ±10% | 1.80 |
| 9 | CL32B333KGHNNN □ | | | 33nF | 500 | ±10% | 1.80 |
| 10 | CL32B473KHHNNN □ | | | 47nF | 630 | ±10% | 1.80 |

- Part Numbering System
- Standard & High Capacitors
- Super Small Size Capacitors
- High-Q Capacitors
- Medium-High Voltage Capacitors
- Array Type Capacitors
- Low ESL Capacitors
- Reliability Test Condition
- Premium Capacitors for Automotive Applications
- Packaging Specification
- Application Manual for Surface Mounting

※ □ mark means packaging code. If you want to learn the code or quantity in detail, please see p74.

Product Lineup (Medium-High Voltage Capacitors-X7R)

| | Part Number | Size L x W (mm) | Capacitance | Rated Voltage (Vdc) | Capacitance Tolerance | Thickness Max.(mm) |
|----|-------------------|--------------------|-------------|---------------------------|--------------------------|-----------------------|
| 11 | CL32B473KDHNNN □ | 3.20×2.50 | 47nF | 200 | ±10% | 1.80 |
| 12 | CL32B473KGFHNNN □ | | 47nF | 500 | ±10% | 1.80 |
| 13 | CL32B683KDINNN □ | | 68nF | 200 | ±10% | 2.20 |
| 14 | CL32B104KEJNNN □ | | 100nF | 250 | ±10% | 2.70 |
| 15 | CL32B104KDINNN □ | | 100nF | 200 | ±10% | 2.20 |
| 16 | CL32B154KCFNNN □ | | 150nF | 100 | ±10% | 1.45 |
| 17 | CL32B154KDJNNN □ | | 150nF | 200 | ±10% | 2.70 |
| 18 | CL32B154KEJNNN □ | | 150nF | 250 | ±10% | 2.70 |
| 19 | CL32B224KCHNNN □ | | 220nF | 100 | ±10% | 1.80 |
| 20 | CL32B224KDJNNN □ | | 220nF | 200 | ±10% | 2.70 |
| 21 | CL32B224KEJNNN □ | | 220nF | 250 | ±10% | 2.70 |
| 22 | CL32B334KCHNNN □ | | 330nF | 100 | ±10% | 1.80 |
| 23 | CL32B474KCIINN □ | | 470nF | 100 | ±10% | 2.20 |
| 24 | CL32B105KCJNNN □ | | 1μF | 100 | ±10% | 2.70 |
| 25 | CL32B155KCHNNN □ | | 1.5μF | 100 | ±10% | 1.80 |
| 26 | CL32B225KCJNNN □ | | 2.2μF | 100 | ±10% | 2.70 |
| 1 | CL43B102KJFNNN □ | 4.50×3.20 | 1nF | 2000 | ±10% | 1.45 |
| 2 | CL43B152KJFNNN □ | | 1.5nF | 2000 | ±10% | 1.45 |
| 3 | CL43B222KIFNNN □ | | 2.2nF | 1000 | ±10% | 1.45 |
| 4 | CL43B222KJFNNN □ | | 2.2nF | 2000 | ±10% | 1.45 |
| 5 | CL43B332KJFNNN □ | | 3.3nF | 2000 | ±10% | 1.45 |
| 6 | CL43B103KIFNNN □ | | 10nF | 1000 | ±10% | 1.45 |
| 7 | CL43B333KIJNNN □ | | 33nF | 1000 | ±10% | 2.70 |
| 8 | CL43B473KGFNNN □ | | 47nF | 500 | ±10% | 1.45 |
| 9 | CL43B473KHFNNN □ | | 47nF | 630 | ±10% | 1.45 |
| 10 | CL43B104KGINNN □ | | 100nF | 500 | ±10% | 2.20 |
| 11 | CL43B104KDFNNN □ | | 100nF | 200 | ±10% | 1.45 |
| 12 | CL43B104KHINNN □ | | 100nF | 630 | ±10% | 2.20 |
| 13 | CL43B224KCFNNN □ | | 220nF | 100 | ±10% | 1.45 |
| 14 | CL43B334KCFNNN □ | | 330nF | 100 | ±10% | 1.45 |
| 15 | CL43B474KEJNNN □ | | 470nF | 250 | ±10% | 2.70 |
| 16 | CL43B474KCHNNN □ | | 470nF | 100 | ±10% | 1.80 |
| 17 | CL43B474KDJNNN □ | | 470nF | 200 | ±10% | 2.70 |
| 18 | CL43B105KCJNNN □ | | 1μF | 100 | ±10% | 2.70 |
| 1 | CL55B103KJHNNN □ | 5.70×5.00 | 10nF | 2000 | ±10% | 1.80 |
| 2 | CL55B473KIINN □ | | 47nF | 1000 | ±10% | 2.20 |
| 3 | CL55B224KGJNNN □ | | 220nF | 500 | ±10% | 2.70 |
| 4 | CL55B224KHJNNN □ | | 220nF | 630 | ±10% | 2.70 |
| 5 | CL55B105KCHNNN □ | | 1μF | 100 | ±10% | 1.80 |
| 6 | CL55B105KDJNNN □ | | 1μF | 200 | ±10% | 2.70 |
| 7 | CL55B105KEJNNN □ | | 1μF | 250 | ±10% | 2.70 |
| 8 | CL55B475KCJNNN □ | | 4.7μF | 100 | ±10% | 2.70 |

※ □ mark means packaging code. If you want to learn the code or quantity in detail, please see p74.



Feature

- Reduction in required space (more than 50%)
- Reduction in cost and time for replacement of PCB
- Reduction in amount of solder joints
- Easier PCB design
- Reduced waste from tape and reel packaging process
- It protect EMI bypassing digital signal line nose

Application

- A bypass for digital and analog signal line noise generated by telecommunication equipment and other common electronic circuits

Structure and Dimensions

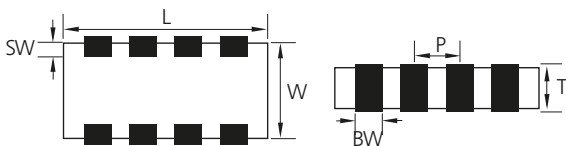

| Code | Size (mm) | EIA Code | Dimension (mm) | | | | | |
|------|-----------|----------|-----------------|-----------------|--|-----------------|-----------------|-----------------|
| | | | L | W | T | BW | SW | P |
| A | 0906 | 0302 | 0.90 ± 0.05 | 0.60 ± 0.05 | 0.45 ± 0.05 | 0.25 ± 0.05 | 0.15 ± 0.1 | 0.45 ± 0.05 |
| A | 1410 | 0504 | 1.37 ± 0.15 | 1.0 ± 0.15 | 0.35 ± 0.05 0.50 ± 0.05 0.60 ± 0.06 0.80 ± 0.08 | 0.36 ± 0.1 | 0.2 ± 0.1 | 0.64 ± 0.1 |
| A | 2012 | 0805 | 2.0 ± 0.15 | 1.25 ± 0.15 | 0.85 ± 0.1 | 0.5 ± 0.2 | 0.25 ± 0.15 | 1.0 ± 0.1 |
| B | 2012 | 0805 | 2.0 ± 0.15 | 1.25 ± 0.15 | 0.85 ± 0.1 | 0.25 ± 0.1 | 0.25 ± 0.15 | 0.5 ± 0.1 |
| B | 3216 | 1206 | 3.2 ± 0.15 | 1.6 ± 0.15 | 0.85 ± 0.15 | 0.4 ± 0.2 | 0.3 ± 0.15 | 0.8 ± 0.2 |

Structure and Control Code

■ A : ARRAY(2-element)



■ B : ARRAY(4-element)

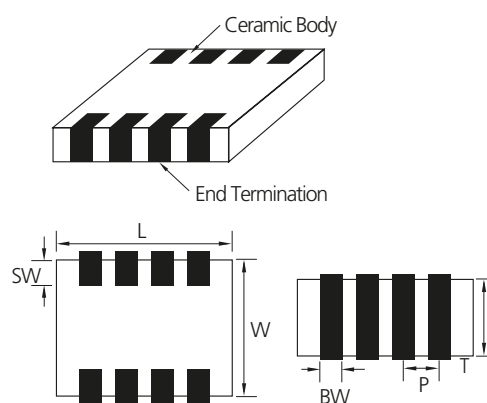

Part Numbering System

Standard & High Capacitors

Super Small Size Capacitors

High-Q Capacitors

Medium-High Voltage Capacitors

Array Type Capacitors

Low ESL Capacitors

Reliability Test Condition

Premium Capacitors for Automotive Applications

Packaging Specification

Application Manual for Surface Mounting

Product Lineup (Array Type Capacitors)

| | Part Number | Element Type | Size L x W (mm) | Capacitance | Rated Voltage (Vdc) | Capacitance Tolerance | Thickness Max.(mm) |
|----|------------------|--------------|-----------------|-------------|---------------------|-----------------------|--------------------|
| 1 | CL14C270KA6NAN □ | 2-Array | 1.40×1.00 | 27pF | 25 | ± 10% | 0.66 |
| 1 | CL31C100JBCNBN □ | 4-Array | 3.20×1.60 | 10pF | 50 | ± 5% | 1.00 |
| 2 | CL31C150JBCNBN □ | | | 15pF | 50 | ± 5% | 1.00 |
| 3 | CL31C220JBCNBN □ | | | 22pF | 50 | ± 5% | 1.00 |
| 4 | CL31C270JBCNBN □ | | | 27pF | 50 | ± 5% | 1.00 |
| 5 | CL31C330KBCNBN □ | | | 33pF | 50 | ± 10% | 1.00 |
| 6 | CL31C390KBCNBN □ | | | 39pF | 50 | ± 10% | 1.00 |
| 7 | CL31C680JBCNBN □ | | | 68pF | 50 | ± 5% | 1.00 |
| 8 | CL31C820JBCNBN □ | | | 82pF | 50 | ± 5% | 1.00 |
| 9 | CL31C101JBCNBN □ | | | 100pF | 50 | ± 5% | 1.00 |
| 10 | CL31C151KBCNBN □ | | | 150pF | 50 | ± 10% | 1.00 |
| 11 | CL31C181JBCNBN □ | | | 180pF | 50 | ± 5% | 1.00 |
| 12 | CL31C331JBCNBN □ | | | 330pF | 50 | ± 5% | 1.00 |
| 13 | CL31C471JBCNBN □ | | | 470pF | 50 | ± 5% | 1.00 |
| 1 | CL21B471KBCNBN □ | 4-Array | 2.00×1.25 | 470pF | 50 | ± 10% | 0.95 |
| 2 | CL21B104KOCNBN □ | | | 100nF | 16 | ± 10% | 0.95 |
| 3 | CL21B104MPCNBN □ | | | 100nF | 10 | ± 20% | 0.95 |
| 1 | CL31B102MBCNBN □ | 4-Array | 3.20×1.60 | 1nF | 50 | ± 20% | 1.00 |
| 2 | CL31B103MBCNBN □ | | | 10nF | 50 | ± 20% | 1.00 |
| 3 | CL31B153KBCNBN □ | | | 15nF | 50 | ± 10% | 1.00 |
| 4 | CL31B473KACNBN □ | | | 47nF | 25 | ± 10% | 1.00 |
| 5 | CL31B104KACNBN □ | | | 100nF | 25 | ± 10% | 1.00 |
| 6 | CL31B104KOCNBN □ | | | 100nF | 16 | ± 10% | 1.00 |
| 1 | CL09A104KP4SAN □ | 2-Array | 0.90×0.60 | 100nF | 10 | ± 10% | 0.50 |
| 2 | CL09A104KQ4SAN □ | | | 100nF | 6.3 | ± 10% | 0.50 |
| 3 | CL09A105MQ4NAN □ | | | 1μF | 6.3 | ± 20% | 0.50 |
| 4 | CL09A105MR4NAN □ | | | 1μF | 4 | ± 20% | 0.50 |
| 1 | CL14A104KA6NAN □ | 2-Array | 1.40×1.00 | 100nF | 25 | ± 10% | 0.66 |
| 2 | CL14A104KO6NAN □ | | | 100nF | 16 | ± 10% | 0.66 |
| 3 | CL14A104KP6NAN □ | | | 100nF | 10 | ± 10% | 0.66 |
| 4 | CL14A105MA5NAN □ | | | 1μF | 25 | ± 20% | 0.55 |
| 5 | CL14A105KP8NAN □ | | | 1μF | 10 | ± 10% | 0.88 |
| 6 | CL14A105MO3NAN □ | | | 1μF | 16 | ± 20% | 0.40 |
| 7 | CL14A105MO8NAN □ | | | 1μF | 16 | ± 20% | 0.88 |
| 8 | CL14A105MO5NAN □ | | | 1μF | 16 | ± 20% | 0.55 |
| 9 | CL14A105MP3NAN □ | | | 1μF | 10 | ± 20% | 0.40 |
| 10 | CL14A105MP5NAN □ | | | 1μF | 10 | ± 20% | 0.55 |
| 11 | CL14A225KP8NAN □ | | | 2.2μF | 10 | ± 10% | 0.88 |
| 12 | CL14A225KQ8NAN □ | | | 2.2μF | 6.3 | ± 10% | 0.88 |
| 1 | CL21A105KOCNAN □ | 2-Array | 2.00×1.25 | 1μF | 16 | ± 10% | 0.95 |
| 2 | CL21A105MPCNAN □ | | | 1μF | 10 | ± 20% | 0.95 |
| 1 | CL31F473ZBCNBN □ | 4-Array | 3.20×1.60 | 47nF | 50 | +80/-20% | 1.00 |
| 2 | CL31F104ZACNBN □ | | | 100nF | 25 | +80/-20% | 1.00 |

※ □ mark means packaging code. If you want to learn the code or quantity in detail, please see p74.

- Part Numbering System
- Standard & High Capacitors
- Super Small Size Capacitors
- High-Q Capacitors
- Medium-High Voltage Capacitors
- Array Type Capacitors
- Low ESL Capacitors
- Reliability Test Condition
- Premium Capacitors for Automotive Applications
- Packaging Specification
- Application Manual for Surface Mounting

Low ESL Capacitors

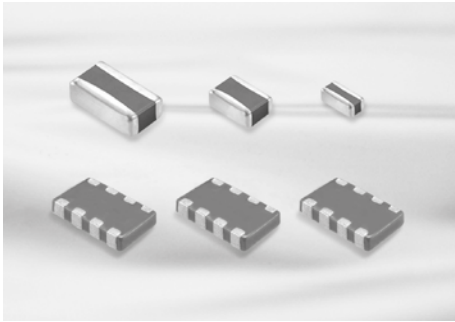

Feature

- Low ESL, good for noise reduction for high frequency
- Highly reliable tolerance and high speed automatic chip placement on PCBs
- Highly reliable performance
- Highly resistant termination metal
- Tape & reel for surface mount assembly

Application

- High Speed Microprocessor
- High Frequency Digital Equipment

LICC(Low Inductance Ceramic Capacitors)

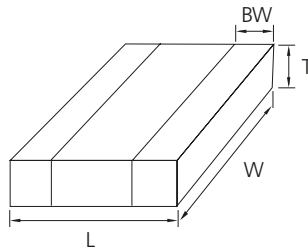

| Code | Size (mm) | EIA Code | Dimension(mm) | | | |
|------|-----------|----------|-----------------|----------------|----------------------|-----------------|
| | | | L | W | T | BW |
| L5 | 0510 | 0204 | 0.52 ± 0.05 | 1.0 ± 0.05 | 0.3 ± 0.05 | 0.18 ± 0.06 |
| 01 | 0816 | 0306 | 0.8 ± 0.15 | 1.6 ± 0.2 | $0.5 + 0.05 / - 0.1$ | 0.25 ± 0.15 |

SLIC(Super Low Inductance Capacitors)

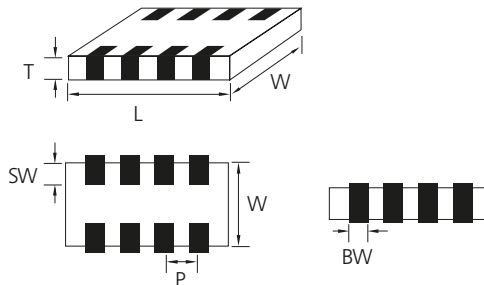

| Code | Size (mm) | EIA Code | Dimension(mm) | | | | | |
|------|-----------|----------|---------------|----------------|----------------------|---------------------|--------------------|---------------|
| | | | L | W | T | BW | SW | P |
| 10 | 1608 | 0603 | 1.6 ± 0.1 | 0.8 ± 0.1 | $0.5 / + 0.05 - 0.1$ | 0.25 ± 0.1 | 0.15 ± 0.1 | 0.4 ± 0.1 |
| 21 | 2012 | 0805 | 2.0 ± 0.1 | 1.25 ± 0.1 | $0.5 / + 0.05 - 0.1$ | $0.25 + 0.15 - 0.1$ | $0.2 + 0.15 - 0.1$ | 0.5 ± 0.1 |

Low ESL capacitance Table (LICC)

| TC | Size(mm) | Tmax(mm) | Vr(V) | Capacitance(μ F) | | | | | | | | | |
|---------------------|------------|----------|-------|-----------------------|-------|-------|-----|------|------|-----|-----|-----|----|
| | | | | 0.01 | 0.022 | 0.047 | 0.1 | 0.22 | 0.47 | 1 | 2.2 | 4.7 | 10 |
| X6S /X7S /X7T | 0204(0510) | 0.35 | 2.5 | | | | | | | | X7T | | |
| | | | 4 | | | | X7S | X6S | | | | | |
| | | | 6.3 | | | | X7S | | | | | | |
| | 0306(0816) | 0.55 | 4 | | | | | | | X7S | | | |

| TC | Size(mm) | Tmax(mm) | Vr(V) | Capacitance(μ F) | | | | | | | | | |
|-------------|------------|----------|-------|-----------------------|-------|-------|-----|------|------|---|-----|-----|----|
| | | | | 0.01 | 0.022 | 0.047 | 0.1 | 0.22 | 0.47 | 1 | 2.2 | 4.7 | 10 |
| X7R /X5R | 0306(0816) | 0.55 | 6.3 | | | X7R | | | | | X5R | | |
| | | | 10 | | | X7R | | | | | | | |
| | | | 16 | | | X7R | | | | | | | |
| | | | 25 | | | X7R | | | | | | | |
| | | | 50 | | X7R | | | | | | | | |

Low ESL capacitance Table (SLIC)

| TC | Size(mm) | Tmax(mm) | Vr(V) | Capacitance(μ F) | | | | | | | | |
|---------------------|------------|----------|-------|-----------------------|------|------|---|-----|-----|----|----|--|
| | | | | 0.1 | 0.47 | 0.68 | 1 | 2.2 | 4.7 | 10 | 22 | |
| X7R /X7S /X7T | 0603(1608) | 0.55 | 4 | | | X7S | | | | | | |
| | 0805(2012) | 0.55 | 4 | | | X7R | | | X7S | | | |
| | | | 6.3 | | | X7R | | | | | | |
| | | | 16 | | | X7R | | | | | | |

Part Numbering System

Standard & High Capacitors

Super Small Size Capacitors

High-Q Capacitors

Medium-High Voltage Capacitors

Array Type Capacitors

Low ESL Capacitors

Reliability Test Condition

Premium Capacitors for Automotive Applications

Packaging Specification

Application Manual for Surface Mounting



Product Lineup (Low ESL Capacitors-X7R, X6S, X7S, X7T)

| | Part Number | Size L x W (mm) | Capacitance | Rated Voltage (Vdc) | Capacitance Tolerance | Thickness Max.(mm) |
|---|-------------------|--------------------|-------------|---------------------------|--------------------------|-----------------------|
| 1 | CL21B104MO5NJJN □ | 2.00×1.25 | 100nF | 16 | ± 20% | 0.55 |
| 2 | CL21B684MO5NJJN □ | | 680nF | 16 | ± 20% | 0.55 |
| 3 | CL21B684MQ5NJJN □ | | 680nF | 6.3 | ± 20% | 0.55 |
| 1 | CLL5X224MR3NJJN □ | 0.50×1.00 | 220nF | 4 | ± 20% | 0.35 |
| 2 | CLL5X474MR3NJJN □ | | 470nF | 4 | ± 20% | 0.35 |
| 3 | CLL5X105MR3NJJN □ | | 1 μ F | 4 | ± 20% | 0.35 |
| 1 | CLL5Y104MQ3NJJN □ | 0.50×1.00 | 100nF | 6.3 | ± 20% | 0.35 |
| 1 | CL01Y105MR5NJJN □ | 0.80×1.60 | 1 μ F | 4 | ± 20% | 0.55 |
| 2 | CL01Y225MR5NJJN □ | | 2.2 μ F | 4 | ± 20% | 0.55 |
| 1 | CL10Y474MR5NJJN □ | 1.60×0.80 | 470nF | 4 | ± 20% | 0.55 |
| 2 | CL10Y105MR5NJJN □ | | 1 μ F | 4 | ± 20% | 0.55 |
| 3 | CL10Y225MR5NJJN □ | | 2.2 μ F | 4 | ± 20% | 0.55 |
| 1 | CL21Y105MR5NJJN □ | 2.00×1.25 | 1 μ F | 4 | ± 20% | 0.55 |
| 2 | CL21Y225MR5NJJN □ | | 2.2 μ F | 4 | ± 20% | 0.55 |
| 1 | CLL5Z105MS3NJJN □ | 0.50×1.00 | 1 μ F | 2.5 | ± 20% | 0.35 |

※ □ mark means packaging code. If you want to learn the code or quantity in detail, please see p74.

| No | Item | Performance | Test Condition | | |
|---|-----------------------------------|--|---|-----------------------------------|--------------|
| 1 | Appearance | No abnormal exterior appearance | Visual Inspection through Microscope (x10) | | |
| 2 | Insulation Resistance | 10,000MΩ min. or 500MΩ · μF min. (or *100MΩ · μF) product whichever is smaller (Rated voltage ≤ 16V: 10,000MΩ min. or 100MΩ · μF min. product whichever is smaller) | Apply the rated voltage for 60~120 sec. Rated voltage > 500V: Insulation Resistance shall be measured with 500 ± 50Vdc | | |
| 3 | Withstanding Voltage | No dielectric breakdown or mechanical breakdown | Apply the specified voltage* for 1~5 sec. Charge / Discharge current limit: 50mA max. *CLASS I (Rated Voltage < 100V) : 300% of the rated Voltage CLASS II (Rated Voltage < 100V) : 250% of the rated Voltage In the case of Vr ≥ 100V products, following condition should be applied. 100V ≤ Rated Voltage < 500V : 200% of the rated Voltage 500V ≤ Rated Voltage < 1000V : 150% of the rated Voltage Rated Voltage ≥ 1000V : 120% of the rated Voltage | | |
| 4 | Capacitance | CLASS I Within the specified tolerance | Capacitance | Frequency | Voltage |
| | | | ≤ 1,000 pF | 1MHz ± 10% | 0.5 ~ 5 Vrms |
| | | > 1,000 pF | 1KHz ± 10% | | |
| | | CLASS II Within the specified tolerance | Capacitance | Frequency | Voltage |
| ≤ 10 μF | 1KHz ± 10% | | 1.0 ± 0.2 Vrms | | |
| > 10 μF | 120Hz ± 20% | | 0.5 ± 0.1 Vrms | | |
| | | * | 1KHz ± 10% | 0.5 ± 0.1 Vrms | |
| * A capacitor prior to measuring the capacitance is heat treated at 150°C+0/-10°C and maintained in ambient air for 24±2 hours. | | | | | |
| Q | CLASS I | Capacitance ≥ 30pF : Q ≥ 1,000 < 30pF : Q ≥ 400 + 20 × C (C : Capacitance) | Capacitance | Frequency | Voltage |
| | | | ≤ 1,000 pF | 1MHz ± 10% | 0.5 ~ 5 Vrms |
| | | > 1,000 pF | 1KHz ± 10% | | |
| 5 | Tan δ | CLASS II | 1. Characteristic : A(X5R) | | |
| | | | Rated Voltage | Spec | |
| | | | 50V / 35V | 0.025 max / 0.05 max* | |
| | | | 25V | 0.025 max / 0.05 max* / 0.10 max* | |
| | | | 16V | 0.035 max / 0.05 max* / 0.10 max* | |
| | | | ≤ 10V | 0.05 max / 0.10 max* | |
| | | | 2. Characteristic : B(X7R), X(X6S), Y(X7S) | | |
| | | | Rated Voltage | Spec | |
| | | | 50V ≥ / 35V / 25V | 0.025 max / 0.05 max* / 0.10 max* | |
| | | | 16V | 0.035 max / 0.10 max* | |
| ≤ 10V | 0.05 max / 0.10 max* | | | | |
| 3. Characteristic : F(Y5V) | | | | | |
| Rated Voltage | Spec | | | | |
| 50V / 35V / 25V | 0.05 max / 0.07 max* / 0.09 max* | | | | |
| 16V | 0.07 max / 0.09 max* / 0.125 max* | | | | |
| 10V | 0.125 max / 0.16 max* | | | | |
| ≤ 6.3V | 0.16 max | | | | |
| You can check the specification at the web site or contact sales people for each product with mark* | | | | | |

※ The conditions of measurement may be altered upon request.

Part Numbering System

Standard & High Capacitors

Super Small Size Capacitors

High-Q Capacitors

Medium-High Voltage Capacitors

Array Type Capacitors

Low ESL Capacitors

Reliability Test Condition

Premium Capacitors for Automotive Applications

Packaging Specification

Application Manual for Surface Mounting

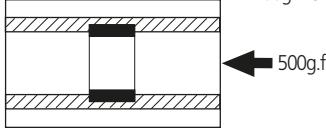
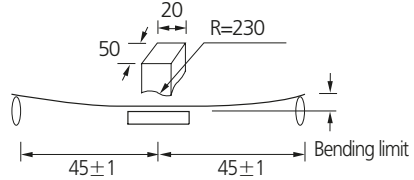
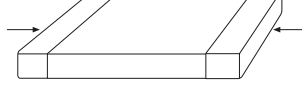
| No | Item | Performance | Test Condition | | | | | | | | | | | | | | | | |
|--|--|---|---|--------------------------|--------------------|--------------|--|-----------|------------------|--|------------|-------------|----------------------------|---|------|---|-------------------------|---|------|
| 6 | Temperature Characteristics of Capacitance | <table border="1"> <tr> <th>Characteristic</th> <th>Temp.Coefficient(PPM/°C)</th> </tr> <tr> <td>C</td> <td>0±30</td> </tr> </table> | Characteristic | Temp.Coefficient(PPM/°C) | C | 0±30 | Capacitance shall be measured by the steps shown in the following table. <table border="1"> <tr> <th>Step</th> <th>Temperature (°C)</th> </tr> <tr> <td>1</td> <td>25±2</td> </tr> <tr> <td>2</td> <td>Min. Operating Temp. ±2</td> </tr> <tr> <td>3</td> <td>25±2</td> </tr> <tr> <td>4</td> <td>Max. Operating Temp. ±2</td> </tr> <tr> <td>5</td> <td>25±2</td> </tr> </table> <p>(1) CLASS I Temperature Coefficient shall be calculated from the formula as below Temp. Coefficient = $\frac{C2-C1}{C1 \times \Delta T} \times 10^6$ [ppm/°C] C1: Capacitance at step 3 C2: Capacitance at 125°C ΔT: 100°C (=125°C - 25°C)</p> <p>(2) CLASS II Capacitance Change shall be calculated from the formula as below $\Delta C = \frac{C2-C1}{C1} \times 100$ (%) C1: Capacitance at step 3 C2: Capacitance at step 2 or 4</p> | Step | Temperature (°C) | 1 | 25±2 | 2 | Min. Operating Temp. ±2 | 3 | 25±2 | 4 | Max. Operating Temp. ±2 | 5 | 25±2 |
| | | Characteristic | Temp.Coefficient(PPM/°C) | | | | | | | | | | | | | | | | |
| C | 0±30 | | | | | | | | | | | | | | | | | | |
| Step | Temperature (°C) | | | | | | | | | | | | | | | | | | |
| 1 | 25±2 | | | | | | | | | | | | | | | | | | |
| 2 | Min. Operating Temp. ±2 | | | | | | | | | | | | | | | | | | |
| 3 | 25±2 | | | | | | | | | | | | | | | | | | |
| 4 | Max. Operating Temp. ±2 | | | | | | | | | | | | | | | | | | |
| 5 | 25±2 | | | | | | | | | | | | | | | | | | |
| <table border="1"> <tr> <th>Characteristic</th> <th>Capacitance Change(%) with No bias</th> </tr> <tr> <td>A(X5R), B(X7R)</td> <td>±15%</td> </tr> <tr> <td>X(X6S), Y(X7S)</td> <td>±22%</td> </tr> <tr> <td>Z(X7T)</td> <td>+22%~-33%</td> </tr> <tr> <td>F(Y5V)</td> <td>+22%~-82%</td> </tr> </table> | Characteristic | Capacitance Change(%) with No bias | A(X5R), B(X7R) | ±15% | X(X6S), Y(X7S) | ±22% | Z(X7T) | +22%~-33% | F(Y5V) | +22%~-82% | | | | | | | | | |
| Characteristic | Capacitance Change(%) with No bias | | | | | | | | | | | | | | | | | | |
| A(X5R), B(X7R) | ±15% | | | | | | | | | | | | | | | | | | |
| X(X6S), Y(X7S) | ±22% | | | | | | | | | | | | | | | | | | |
| Z(X7T) | +22%~-33% | | | | | | | | | | | | | | | | | | |
| F(Y5V) | +22%~-82% | | | | | | | | | | | | | | | | | | |
| 7 | Adhesive Strength of Termination | No indication of peeling shall occur on the terminal electrode | Apply 500g.f* pressure for 10±1 sec. *200g.f for 0201 *100g.f for 01005  | | | | | | | | | | | | | | | | |
| 8 | Appearance | No indication of peeling shall occur | <ul style="list-style-type: none"> Bending Limit: 1mm Test Speed: 1.0mm/sec. Keep the test board at the limit point in 5 sec. Then Measure Capacitance  | | | | | | | | | | | | | | | | |
| | Capacitance | <table border="1"> <tr> <th>Characteristic</th> <th>Capacitance Change</th> </tr> <tr> <td>CLASS I</td> <td>±5% or ±0.5 pF whichever is larger</td> </tr> <tr> <td>CLASS II</td> <td></td> </tr> <tr> <td>A(X5R), B(X7R), X(X6S), Y(X7S), Z(X7T)</td> <td>±12.5%</td> </tr> <tr> <td>F(Y5V)</td> <td>±30%</td> </tr> </table> | | Characteristic | Capacitance Change | CLASS I | ±5% or ±0.5 pF whichever is larger | CLASS II | | A(X5R), B(X7R), X(X6S), Y(X7S), Z(X7T) | ±12.5% | F(Y5V) | ±30% | | | | | | |
| Characteristic | Capacitance Change | | | | | | | | | | | | | | | | | | |
| CLASS I | ±5% or ±0.5 pF whichever is larger | | | | | | | | | | | | | | | | | | |
| CLASS II | | | | | | | | | | | | | | | | | | | |
| A(X5R), B(X7R), X(X6S), Y(X7S), Z(X7T) | ±12.5% | | | | | | | | | | | | | | | | | | |
| F(Y5V) | ±30% | | | | | | | | | | | | | | | | | | |
| 9 | Solderability | More than 75% of the terminal surface is to be soldered newly, so metal part does not come out or dissolve  | <table border="1"> <tr> <td>Solder</td> <td>Sn-3Ag-0.5Cu</td> </tr> <tr> <td>Solder Temp.</td> <td>245±5°C</td> </tr> <tr> <td>Flux</td> <td>RMA Type</td> </tr> <tr> <td>Dip time</td> <td>3±0.3 sec.</td> </tr> <tr> <td>Pre-heating</td> <td>at 80~120°C for 10~30 sec.</td> </tr> </table> | Solder | Sn-3Ag-0.5Cu | Solder Temp. | 245±5°C | Flux | RMA Type | Dip time | 3±0.3 sec. | Pre-heating | at 80~120°C for 10~30 sec. | | | | | | |
| Solder | Sn-3Ag-0.5Cu | | | | | | | | | | | | | | | | | | |
| Solder Temp. | 245±5°C | | | | | | | | | | | | | | | | | | |
| Flux | RMA Type | | | | | | | | | | | | | | | | | | |
| Dip time | 3±0.3 sec. | | | | | | | | | | | | | | | | | | |
| Pre-heating | at 80~120°C for 10~30 sec. | | | | | | | | | | | | | | | | | | |
| 10 | Appearance | No mechanical damage shall occur | Solder temperature: 270±5°C, DIP TIME: 10±1 sec. Each termination shall be fully immersed and preheated as below: <table border="1"> <tr> <th>Step</th> <th>Temperature(°C)</th> <th>Time (sec.)</th> </tr> <tr> <td>1</td> <td>80~100</td> <td>60</td> </tr> <tr> <td>2</td> <td>150~180</td> <td>60</td> </tr> </table> <p>Leave the capacitor in ambient condition for specified time* before measurement *24±2 hours(CLASS I) 24±2 hours(CLASS II)</p> | Step | Temperature(°C) | Time (sec.) | 1 | 80~100 | 60 | 2 | 150~180 | 60 | | | | | | | |
| | Step | Temperature(°C) | | Time (sec.) | | | | | | | | | | | | | | | |
| | 1 | 80~100 | | 60 | | | | | | | | | | | | | | | |
| | 2 | 150~180 | | 60 | | | | | | | | | | | | | | | |
| | Capacitance | <table border="1"> <tr> <th>Characteristic</th> <th>Capacitance Change</th> </tr> <tr> <td>CLASS I</td> <td>±2.5% or ±0.25 pF whichever is larger</td> </tr> <tr> <td>CLASS II</td> <td></td> </tr> <tr> <td>A(X5R), B(X7R), X(X6S), Y(X7S), Z(X7T)</td> <td>±7.5%</td> </tr> <tr> <td>F(Y5V)</td> <td>±20%</td> </tr> </table> | | Characteristic | Capacitance Change | CLASS I | ±2.5% or ±0.25 pF whichever is larger | CLASS II | | A(X5R), B(X7R), X(X6S), Y(X7S), Z(X7T) | ±7.5% | F(Y5V) | ±20% | | | | | | |
| | Characteristic | Capacitance Change | | | | | | | | | | | | | | | | | |
| | CLASS I | ±2.5% or ±0.25 pF whichever is larger | | | | | | | | | | | | | | | | | |
| CLASS II | | | | | | | | | | | | | | | | | | | |
| A(X5R), B(X7R), X(X6S), Y(X7S), Z(X7T) | ±7.5% | | | | | | | | | | | | | | | | | | |
| F(Y5V) | ±20% | | | | | | | | | | | | | | | | | | |
| Q (CLASS I) | Within the specified initial value | | | | | | | | | | | | | | | | | | |
| Tanδ (CLASS II) | Within the specified initial value | | | | | | | | | | | | | | | | | | |
| Insulation resistance | Within the specified initial value | | | | | | | | | | | | | | | | | | |
| Withstanding voltage | Within the specified initial value | | | | | | | | | | | | | | | | | | |

| No | Item | Performance | Test Condition | | | |
|-------------------------|---|-------------|----------------------------------|---|---|--------------|
| 11 | Vibration Test | Appearance | No mechanical damage shall occur | The capacitor shall be subjected to a harmonic motion having a total amplitude of 1.5mm changing frequency from 10Hz to 55Hz and back to 10Hz in about 1 min. Repeat this for 2hours each in 3 mutually perpendicular directions. | | |
| | | Capacitance | Characteristic | | Capacitance Change | |
| | | | CLASS I | | $\pm 2.5\%$ or ± 0.25 pF whichever is larger | |
| | | | CLASS II | | A(X5R), B(X7R) | $\pm 5\%$ |
| | | | | | X(X6S), Y(X7S) Z(X7T) | $\pm 10\%$ |
| | | F(Y5V) | | | $\pm 20\%$ | |
| Q (CLASS I) | Within the specified initial value | | | | | |
| Tan δ (CLASS II) | Within the specified initial value | | | | | |
| Insulation resistance | Within the specified initial value | | | | | |
| 12 | Moisture Resistance | Appearance | No mechanical damage shall occur | Applied Voltage: rated voltage Temperature: $40 \pm 2^\circ\text{C}$ Humidity: 90~95% RH Duration Time: 500+12/-0 Hr. Charge/Discharge Current: 50mA max. Perform the initial measurement according to Note1. Perform the final measurement according to Note2. | | |
| | | Capacitance | Characteristic | | Capacitance Change | |
| | | | CLASS I | | $\pm 7.5\%$ or ± 0.75 pF whichever is larger | |
| | | | CLASS II | | A(X5R), B(X7R), X(X6S), Y(X7S) Z(X7T) | $\pm 12.5\%$ |
| | | | | | F(Y5V) | $\pm 30\%$ |
| | | Q (CLASS I) | | | Capacitance ≥ 30 pF : $Q \geq 200$ < 30 pF : $Q \geq 100 + 10/3 \times C$ (C: Capacitance) | |
| Tan δ (CLASS II) | 1.Capacitance: A(X5R) 0.05 max / 0.075 max* (35V / 50V) 0.05 max / 0.075 max* / 0.125 max*(16V / 25V) 0.075 max / 0.125 max* (≤ 10 V) 2.Capacitance: B(X7R), X(X6S) 0.05 max / 0.125 max* (16V / 25V / 35V / 50V \geq) 0.075 max / 0.125 max* (≤ 10 V) 3.Capacitance: F(Y5V) 0.09 max (50V) 0.09 max / 0.125 max* (25V / 35V) 0.09 max / 0.125 max* / 0.16 max* (16V) 0.16 max / 0.195 max* (10V) 0.195 max (4V / 6.3V) | | | | | |
| Insulation resistance | 500M Ω min. or 25M Ω $\cdot \mu\text{F}$ min. product whichever is smaller / 12.5M Ω $\cdot \mu\text{F}$ or over* | | | | | |
| 13 | High Temperature Resistance | Appearance | No mechanical damage shall occur | Temperature : max. operating temperature Duration Time: 1000+48/-0 Hr. Charge/Discharge Current: 50mA max. Vr ≤ 200 V : 200% of the rated Voltage 250V \leq Vr ≤ 500 V : 150% of the rated Voltage Vr=630V : 120% of the rated Voltage 1000V \leq Vr ≤ 3000 V : 100% of the rated Voltage * : 150% or 100% of the rated Voltage Perform the initial measurement according to Note1 for class II Perform the final measurement according to Note2. | | |
| | | Capacitance | Characteristic | | Capacitance Change | |
| | | | CLASS I | | $\pm 3\%$ or ± 0.3 pF whichever is larger | |
| | | | CLASS II | | A(X5R), B(X7R), X(X6S), Y(X7S) Z(X7T) | $\pm 12.5\%$ |
| | | | | | F(Y5V) | $\pm 30\%$ |
| | | Q (CLASS I) | | | Capacitance ≥ 30 pF : $Q \geq 350$ 10 \leq Capacitance < 30 pF : $Q \geq 275 + 2.5 \times C$ Capacitance < 10 pF : $Q \geq 200 + 10 \times C$ (C: Capacitance) | |
| Tan δ (CLASS II) | 1.Capacitance : A(X5R) 0.05 max / 0.075 max* (35V / 50V) 0.05 max / 0.075 max* / 0.125 max*(16V / 25V) 0.075 max / 0.125 max* (≤ 10 V) 2.Capacitance : B(X7R), X(X6S) 0.05 max / 0.125 max* (16V / 25V / 35V / 50V \geq) 0.075 max / 0.125 max* (≤ 10 V) 3.Capacitance : F(Y5V) 0.09 max (50V) 0.09 max / 0.125 max* (25V / 35V) 0.09 max / 0.125 max* / 0.16 max* (16V) 0.16 max / 0.195 max* (10V) 0.195 max (4V / 6.3V) | | | | | |
| Insulation resistance | 1,000M Ω min. or 50M Ω $\cdot \mu\text{F}$ min. product whichever is smaller / 25M Ω $\cdot \mu\text{F}$ or over* | | | | | |

Part Numbering System

Standard & High Capacitors

Super Small Size Capacitors

High-Q Capacitors

Medium-High Voltage Capacitors

Array Type Capacitors

Low ESL Capacitors

Reliability Test Condition

Premium Capacitors for Automotive Applications

Packaging Specification

Application Manual for Surface Mounting



| No | Item | Performance | Test Condition | | | | | | | | | | | | | | | |
|-------------------------|------------------------------------|-------------|---|--------------------------|--|------------|---|----------------------------------|----|---|----|-----|---|----------------------------------|----|---|----|-----|
| 14 | Temperature Cycle | Appearance | No mechanical damage shall occur | | | | | | | | | | | | | | | |
| | | Capacitance | Characteristic | Capacitance Change | | | | | | | | | | | | | | |
| | | | CLASS I | | $\pm 2.5\%$ or $\pm 0.25\text{pF}$ whichever is larger | | | | | | | | | | | | | |
| | | | CLASS II | A(X5R), B(X7R) | $\pm 7.5\%$ | | | | | | | | | | | | | |
| | | | | X(X6S), Y(X7S) Z(X7T) | $\pm 15\%$ | | | | | | | | | | | | | |
| | | F(Y5V) | | $\pm 20\%$ | | | | | | | | | | | | | | |
| | | Q (CLASS I) | Within the specified initial value | | | | | | | | | | | | | | | |
| Tan δ (CLASS II) | Within the specified initial value | | | | | | | | | | | | | | | | | |
| Insulation resistance | Within the specified initial value | | | | | | | | | | | | | | | | | |
| | | | Capacitor shall be subjected to 5 cycles. Condition for 1 cycle: | | | | | | | | | | | | | | | |
| | | | <table border="1"> <thead> <tr> <th>Step</th> <th>Temperature(°C)</th> <th>Time(min.)</th> </tr> </thead> <tbody> <tr> <td>1</td> <td>min. operating temperature +0/-3</td> <td>30</td> </tr> <tr> <td>2</td> <td>25</td> <td>2~3</td> </tr> <tr> <td>3</td> <td>max. operating temperature +0/-3</td> <td>30</td> </tr> <tr> <td>4</td> <td>25</td> <td>2~3</td> </tr> </tbody> </table> | Step | Temperature(°C) | Time(min.) | 1 | min. operating temperature +0/-3 | 30 | 2 | 25 | 2~3 | 3 | max. operating temperature +0/-3 | 30 | 4 | 25 | 2~3 |
| Step | Temperature(°C) | Time(min.) | | | | | | | | | | | | | | | | |
| 1 | min. operating temperature +0/-3 | 30 | | | | | | | | | | | | | | | | |
| 2 | 25 | 2~3 | | | | | | | | | | | | | | | | |
| 3 | max. operating temperature +0/-3 | 30 | | | | | | | | | | | | | | | | |
| 4 | 25 | 2~3 | | | | | | | | | | | | | | | | |
| | | | Leave the capacitor in ambient condition for specified time* before measurement *24 \pm 2 hours(CLASS I) 24 \pm 2 hours(CLASS II) | | | | | | | | | | | | | | | |

| No | Recommended Soldering Method | | | | | | |
|-------------|---|------------------|-------------------------------|-----------------------|--------------------------|--------|---|
| 15 | Recommended Soldering Method By Size & Capacitance | Size inch(mm) | Temperature Characteristic | Capacitance | Condition | | |
| | | | | | Flow | Reflow | |
| | | 01005(0402) | - | - | - | - | ○ |
| | | 0201 (0603) | | | | | |
| | | 0402 (1005) | | | | | |
| | | 0603(1608) | Class I | - | - | ○ | ○ |
| | | | Class II | $C < 1 \mu\text{F}$ | - | ○ | ○ |
| | | | | | $C \geq 1 \mu\text{F}$ | - | ○ |
| | | 0805 (2012) | Class I | - | - | ○ | ○ |
| | | | Class II | $C < 4.7 \mu\text{F}$ | - | ○ | ○ |
| | | | | | $C \geq 4.7 \mu\text{F}$ | - | ○ |
| | | | Array | - | - | - | ○ |
| | | 1206 (3216) | Class I | - | - | ○ | ○ |
| | | | Class II | $C < 10 \mu\text{F}$ | - | ○ | ○ |
| | | | | | $C \geq 10 \mu\text{F}$ | - | - |
| | Array | - | - | - | ○ | | |
| 1210 (3225) | - | - | - | - | ○ | | |
| 1808 (4520) | | | | | ○ | | |
| 1812 (4532) | | | | | ○ | | |
| 2220 (5750) | | | | | ○ | | |
| | | | | | ○ | | |

Note 1. Initial Measurement For Class II

Perform the heat treatment at 150°C +0/-10°C for 1 hour. Then Leave the capacitor in ambient condition for 24 \pm 2 hours before measurement. Then perform the measurement.

Note 2. Latter Measurement

1. CLASS I

Leave the capacitor in ambient condition for 24 \pm 2 hours before measurement. Then perform the measurement.

2. CLASS II

Perform the heat treatment at 150°C +0/-10°C for 1 hour. Then Leave the capacitor in ambient condition for 24 \pm 2 hours before measurement. Then perform the measurement.

Note 3. All Size in Reliability Test Condition Section is "inch"

Note 4. Camera Strobe Circuit Capacitors Should be Following a Special Reliability Test Condition.
Please check with our sales representatives or product engineers.



Premium Capacitors for Automotive Applications

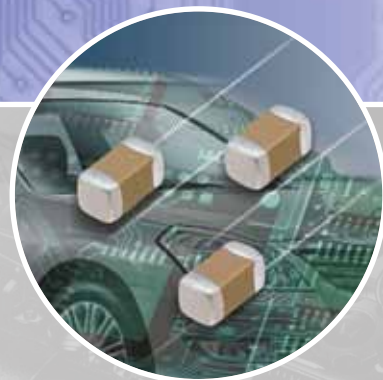

SAMSUNG
ELECTRO-MECHANICS

SAMSUNG

*** Class I**

| Symbol | EIA Code | Operation Temperature Range(°C) | Temperature Coefficient Range(ppm/°C) |
|--------|----------|---------------------------------|---------------------------------------|
| C | C0G | -55~+125 | 0±30 |

Class II

| Symbol | EIA Code | Operation Temperature Range(°C) | Capacitance Change(ΔC%) |
|--------|----------|---------------------------------|-------------------------|
| B | X7R | -55~+125 | 0±15 |

**** Capacitance Tolerance**

| Code | Capacitance Tolerance | TC | Capacitance Step | Rated Capacitance |
|------|-----------------------|-----|------------------|-------------------|
| C | ±0.25pF | C0G | Under 5pF | E-12 series * |
| D | ±0.5pF | C0G | 6.0 to 9.0pF | E-12 series * |
| J | ±5% | C0G | Over 10pF | E-12 series |
| K | ±10% | X7R | Under 0.01μF | E-3 series |
| | | | Over 0.01μF | E-6 series |
| M | ±20% | X7R | Under 0.01μF | E-3 series |
| | | | Over 0.01μF | E-6 series |

* E-24 series is also available

| Series | Capacitance Step | | | | | | | | | | | |
|--------|------------------|-----|-----|-----|-----|-----|-----|-----|-----|-----|-----|-----|
| | 1.0 | | | | 2.2 | | | | 4.7 | | | |
| E-3 | 1.0 | | | | 2.2 | | | | 4.7 | | | |
| E-6 | 1.0 | | 1.5 | | 2.2 | | 3.3 | | 4.7 | | 6.8 | |
| E-12 | 1.0 | 1.2 | 1.5 | 1.8 | 2.2 | 2.7 | 3.3 | 3.9 | 4.7 | 5.6 | 6.8 | 8.2 |
| E-24 | 1.0 | 1.1 | 1.2 | 1.3 | 2.2 | 2.4 | 2.7 | 3.0 | 4.7 | 5.1 | 5.6 | 6.2 |
| | 1.5 | 1.6 | 1.8 | 2.0 | 3.3 | 3.6 | 3.9 | 4.3 | 6.8 | 7.5 | 8.2 | 9.1 |

| Size | Code | Thickness(mm) | Spec(mm) * |
|------------|------|---------------|------------|
| 0402(1005) | 5 | 0.50 | ±0.05 |
| 0603(1608) | 8 | 0.80 | ±0.10 |
| 0805(2012) | 6 | 0.60 | ±0.10 |
| | C | 0.85 | ±0.10 |
| | F | 1.25 | ±0.10 |
| | Q | 1.25 | ±0.15 |
| 1206(3216) | C | 0.85 | ±0.15 |
| | P | 1.15 | ±0.10 |
| | H | 1.60 | ±0.20 |
| 1210(3225) | I | 2.00 | ±0.20 |
| | J | 2.50 | ±0.20 |

Part Numbering System

Standard & High Capacitors

Super Small Size Capacitors

High-Q Capacitors

Medium-High Voltage Capacitors

Array Type Capacitors

Low ESL Capacitors

Reliability Test Condition

Premium Capacitors for Automotive Applications

Packaging Specification

Application Manual for Surface Mounting

Premium Capacitors for Automotive Applications

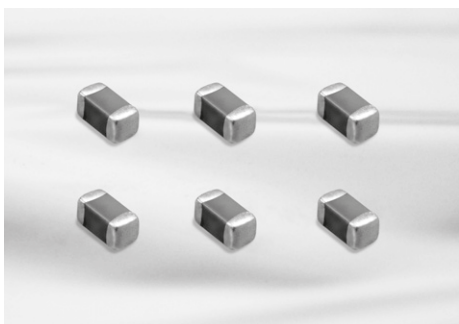

Feature

- Automotive products are manufactured in state of the art facilities recommended for registration to ISO/TS 16949:2002.
- Automotive products meet AEC-Q-200 requirements.
- Automotive products are RoHS compliant.
- Samsung terminations are suitable for all flow and reflow soldering systems. (10/21/31 size type only)
- Automotive products meet JEDEC-020-D requirements.
- COG dielectric components contain BME and copper terminations with a Ni/Sn plated overcoat.
- X7R dielectric components have BME and soft terminations with a Ni/Sn plated overcoat.

Application

- Automotive Electronic Equipment
(Powertrain, Safety, Body & Chassis, Convenience, Infotainment)

Structure and Dimensions



| Code | EIA Code | Dimension(mm) | | | |
|------|----------|---------------|-----------|--------------|--------------|
| | | L | W | T | BW |
| 05 | 0402 | 1.00±0.05 | 0.50±0.05 | 0.50(± 0.05) | 0.25±0.10 |
| 10 | 0603 | 1.60±0.10 | 0.80±0.10 | 0.80(± 0.10) | 0.30±0.20 |
| 21 | 0805 | 2.00±0.10 | 1.25±0.10 | 0.60(± 0.10) | 0.5+0.2/-0.3 |
| | | | | 0.85(± 0.10) | |
| | | | | 1.25(± 0.10) | |
| | | 2.00±0.15 | 1.25±0.15 | 1.25(± 0.15) | |
| 31 | 1206 | 3.20±0.20 | 1.60±0.20 | 0.85(± 0.15) | 0.50±0.30 |
| | | | | 1.15(± 0.10) | |
| | | | | 1.60(± 0.20) | |
| 32 | 1210 | 3.20±0.30 | 2.50±0.20 | 2.00(± 0.20) | 0.60±0.30 |
| | | | | 2.50(± 0.20) | |

Automotive Capacitors Table (C0G, X7R)

| TC | Size (mm) | Thickness (mm) | Vr | Capacitance (pF) | | | Capacitance (nF) | | | | | | | | |
|------------|------------|----------------------|-------|------------------|-------|-----|------------------|-----|------------------|----|-----|-----|-----|----|--|
| | | | | 100 | 220 | 470 | 1 | 2.2 | 4.7 | 10 | 22 | 47 | 100 | | |
| COG | 0402(1005) | 0.50 | 50 | [Bar] | | | | | | | | | | | |
| | | | 100 | [Bar] | | | | | | | | | | | |
| | 0603(1608) | 0.80 | 50 | [Bar] | | | | | | | | | | | |
| | | | 100 | [Bar] | | | 271 | | | | | | | | |
| | 0805(2012) | 0.60 0.85 1.25 | 50 | [Bar] | | | | | | | | | | | |
| | | | 100 | [Bar] | | | | | | | | | | | |
| TC | Size (mm) | Thickness (mm) | Vr | Capacitance (nF) | | | | | Capacitance (μF) | | | | | | |
| | | | | 10 | 22 | 47 | 100 | 220 | 470 | 1 | 2.2 | 4.7 | 10 | 22 | |
| X7R | 0402(1005) | 0.50 | 10 | [Bar] | | | | | | | | | | | |
| | | | 16 | [Bar] | | | | | | | | | | | |
| | | | 25 | [Bar] | | | | | | | | | | | |
| | | | 50 | [Bar] | | | | | | | | | | | |
| | 0603(1608) | 0.80 | 10 | [Bar] | | | | | | | | | | | |
| | | | 16 | [Bar] | | | | | | | | | | | |
| | | | 25 | [Bar] | | | | | | | | | | | |
| | | | 50 | [Bar] | | | | | | | | | | | |
| | | | 100 | [Bar] | | | | | | | | | | | |
| | 0805(2012) | 1.25 | 16 | 10 | [Bar] | | | | | | | | | | |
| | | | | 16 | [Bar] | | | | | | | | | | |
| | | | | 25 | [Bar] | | | | | | | | | | |
| | | 0.85 | 25 | 10 | [Bar] | | | | | | | | | | |
| | | | | 16 | [Bar] | | | | | | | | | | |
| | | | | 25 | [Bar] | | | | | | | | | | |
| | | 0.60 | 50 | 10 | [Bar] | | | | | | | | | | |
| | | | | 16 | [Bar] | | | | | | | | | | |
| | | | | 25 | [Bar] | | | | | | | | | | |
| | | 1.25 | 100 | 10 | [Bar] | | | | | | | | | | |
| | | | | 16 | [Bar] | | | | | | | | | | |
| | | | | 25 | [Bar] | | | | | | | | | | |
| | 1206(3216) | 1.60 | 16 | 10 | [Bar] | | | | | | | | | | |
| | | | | 16 | [Bar] | | | | | | | | | | |
| | | | | 25 | [Bar] | | | | | | | | | | |
| 1.15 | | 25 | 10 | [Bar] | | | | | | | | | | | |
| | | | 16 | [Bar] | | | | | | | | | | | |
| | | | 25 | [Bar] | | | | | | | | | | | |
| 0.85 | | 50 | 10 | [Bar] | | | | | | | | | | | |
| | | | 25 | [Bar] | | | | | | | | | | | |
| 1.60 | 16 | 10 | [Bar] | | | | | | | | | | | | |
| | | 25 | [Bar] | | | | | | | | | | | | |
| 3225(1210) | 2.70 | 16 | 10 | [Bar] | | | | | | | | | | | |

- Part Numbering System
- Standard & High Capacitors
- Super Small Size Capacitors
- High-Q Capacitors
- Medium-High Voltage Capacitors
- Array Type Capacitors
- Low ESL Capacitors
- Reliability Test Condition
- Premium Capacitors for Automotive Applications
- Packaging Specification
- Application Manual for Surface Mounting



Product Lineup (Automotive Capacitors-COG)

| | Part Number | Size L x W (mm) | Capacitance | Rated Voltage (Vdc) | Capacitance Tolerance | Thickness Max.(mm) |
|----|------------------|--------------------|-------------|---------------------------|--------------------------|-----------------------|
| 1 | CL05C4R7CB51PN □ | 1.00×0.50 | 4.7pF | 50 | ±0.25pF | 0.55 |
| 2 | CL05C4R7CC51PN □ | | 4.7pF | 100 | ±0.25pF | 0.55 |
| 3 | CL05C6R8DB51PN □ | | 6.8pF | 50 | ±0.5pF | 0.55 |
| 4 | CL05C6R8DC51PN □ | | 6.8pF | 100 | ±0.5pF | 0.55 |
| 5 | CL05C100JB51PN □ | | 10pF | 50 | ±5% | 0.55 |
| 6 | CL05C100JC51PN □ | | 10pF | 100 | ±5% | 0.55 |
| 7 | CL05C120JB51PN □ | | 12pF | 50 | ±5% | 0.55 |
| 8 | CL05C120JC51PN □ | | 12pF | 100 | ±5% | 0.55 |
| 9 | CL05C150JB51PN □ | | 15pF | 50 | ±5% | 0.55 |
| 10 | CL05C150JC51PN □ | | 15pF | 100 | ±5% | 0.55 |
| 11 | CL05C180JB51PN □ | | 18pF | 50 | ±5% | 0.55 |
| 12 | CL05C180JC51PN □ | | 18pF | 100 | ±5% | 0.55 |
| 13 | CL05C220JB51PN □ | | 22pF | 50 | ±5% | 0.55 |
| 14 | CL05C220JC51PN □ | | 22pF | 100 | ±5% | 0.55 |
| 15 | CL05C270JB51PN □ | | 27pF | 50 | ±5% | 0.55 |
| 16 | CL05C270JC51PN □ | | 27pF | 100 | ±5% | 0.55 |
| 17 | CL05C330JB51PN □ | | 33pF | 50 | ±5% | 0.55 |
| 18 | CL05C330JC51PN □ | | 33pF | 100 | ±5% | 0.55 |
| 19 | CL05C390JB51PN □ | | 39pF | 50 | ±5% | 0.55 |
| 20 | CL05C390JC51PN □ | | 39pF | 100 | ±5% | 0.55 |
| 21 | CL05C470JB51PN □ | | 47pF | 50 | ±5% | 0.55 |
| 22 | CL05C470JC51PN □ | | 47pF | 100 | ±5% | 0.55 |
| 23 | CL05C560JB51PN □ | | 56pF | 50 | ±5% | 0.55 |
| 24 | CL05C560JC51PN □ | | 56pF | 100 | ±5% | 0.55 |
| 25 | CL05C680JB51PN □ | | 68pF | 50 | ±5% | 0.55 |
| 26 | CL05C680JC51PN □ | | 68pF | 100 | ±5% | 0.55 |
| 27 | CL05C820JB51PN □ | | 82pF | 50 | ±5% | 0.55 |
| 28 | CL05C820JC51PN □ | | 82pF | 100 | ±5% | 0.55 |
| 29 | CL05C101JB51PN □ | | 100pF | 50 | ±5% | 0.55 |
| 30 | CL05C101JC51PN □ | | 100pF | 100 | ±5% | 0.55 |
| 31 | CL05C121JB51PN □ | | 120pF | 50 | ±5% | 0.55 |
| 32 | CL05C151JB51PN □ | | 150pF | 50 | ±5% | 0.55 |
| 33 | CL05C221JB51PN □ | | 220pF | 50 | ±5% | 0.55 |
| 1 | CL10C4R7CB81PN □ | 1.60×0.80 | 4.7pF | 50 | ±0.25pF | 0.90 |
| 2 | CL10C4R7CC81PN □ | | 4.7pF | 100 | ±0.25pF | 0.90 |
| 3 | CL10C6R8DB81PN □ | | 6.8pF | 50 | ±0.5pF | 0.90 |
| 4 | CL10C6R8DC81PN □ | | 6.8pF | 100 | ±0.5pF | 0.90 |
| 5 | CL10C100JB81PN □ | | 10pF | 50 | ±5% | 0.90 |
| 6 | CL10C100JC81PN □ | | 10pF | 100 | ±5% | 0.90 |
| 7 | CL10C120JB81PN □ | | 12pF | 50 | ±5% | 0.90 |
| 8 | CL10C120JC81PN □ | | 12pF | 100 | ±5% | 0.90 |
| 9 | CL10C150JB81PN □ | | 15pF | 50 | ±5% | 0.90 |
| 10 | CL10C150JC81PN □ | | 15pF | 100 | ±5% | 0.90 |
| 11 | CL10C180JB81PN □ | | 18pF | 50 | ±5% | 0.90 |
| 12 | CL10C180JC81PN □ | | 18pF | 100 | ±5% | 0.90 |
| 13 | CL10C220JB81PN □ | | 22pF | 50 | ±5% | 0.90 |
| 14 | CL10C220JC81PN □ | | 22pF | 100 | ±5% | 0.90 |
| 15 | CL10C270JB81PN □ | | 27pF | 50 | ±5% | 0.90 |
| 16 | CL10C270JC81PN □ | | 27pF | 100 | ±5% | 0.90 |
| 17 | CL10C330JB81PN □ | | 33pF | 50 | ±5% | 0.90 |

※ □ mark means packaging code. If you want to learn the code or quantity in detail, please see p74.

Product Lineup (Automotive Capacitors-COG)

| | Part Number | Size L x W (mm) | Capacitance | Rated Voltage (Vdc) | Capacitance Tolerance | Thickness Max.(mm) |
|----|------------------|-----------------|-------------|---------------------|-----------------------|--------------------|
| 18 | CL10C330JC81PN □ | 1.60×0.80 | 33pF | 100 | ±5% | 0.90 |
| 19 | CL10C390JB81PN □ | | 39pF | 50 | ±5% | 0.90 |
| 20 | CL10C390JC81PN □ | | 39pF | 100 | ±5% | 0.90 |
| 21 | CL10C470JB81PN □ | | 47pF | 50 | ±5% | 0.90 |
| 22 | CL10C470JC81PN □ | | 47pF | 100 | ±5% | 0.90 |
| 23 | CL10C560JB81PN □ | | 56pF | 50 | ±5% | 0.90 |
| 24 | CL10C560JC81PN □ | | 56pF | 100 | ±5% | 0.90 |
| 25 | CL10C680JB81PN □ | | 68pF | 50 | ±5% | 0.90 |
| 26 | CL10C680JC81PN □ | | 68pF | 100 | ±5% | 0.90 |
| 27 | CL10C820JB81PN □ | | 82pF | 50 | ±5% | 0.90 |
| 28 | CL10C820JC81PN □ | | 82pF | 100 | ±5% | 0.90 |
| 29 | CL10C101JB81PN □ | | 100pF | 50 | ±5% | 0.90 |
| 30 | CL10C101JC81PN □ | | 100pF | 100 | ±5% | 0.90 |
| 31 | CL10C121JB81PN □ | | 120pF | 50 | ±5% | 0.90 |
| 32 | CL10C151JB81PN □ | | 150pF | 50 | ±5% | 0.90 |
| 33 | CL10C221JB81PN □ | | 220pF | 50 | ±5% | 0.90 |
| 34 | CL10C221JC81PN □ | | 220pF | 100 | ±5% | 0.90 |
| 35 | CL10C271JB81PN □ | | 270pF | 50 | ±5% | 0.90 |
| 36 | CL10C331JB81PN □ | | 330pF | 50 | ±5% | 0.90 |
| 37 | CL10C391JB81PN □ | | 390pF | 50 | ±5% | 0.90 |
| 38 | CL10C471JB81PN □ | | 470pF | 50 | ±5% | 0.90 |
| 39 | CL10C561JB81PN □ | | 560pF | 50 | ±5% | 0.90 |
| 40 | CL10C681JB81PN □ | | 680pF | 50 | ±5% | 0.90 |
| 41 | CL10C821JB81PN □ | | 820pF | 50 | ±5% | 0.90 |
| 42 | CL10C102JB81PN □ | 1.0nF | 50 | ±5% | 0.90 | |
| 1 | CL21C100JB61PN □ | 2.00×1.25 | 10pF | 50 | ±5% | 0.70 |
| 2 | CL21C100JC61PN □ | | 10pF | 100 | ±5% | 0.70 |
| 3 | CL21C120JB61PN □ | | 12pF | 50 | ±5% | 0.70 |
| 4 | CL21C120JC61PN □ | | 12pF | 100 | ±5% | 0.70 |
| 5 | CL21C150JB61PN □ | | 15pF | 50 | ±5% | 0.70 |
| 6 | CL21C150JC61PN □ | | 15pF | 100 | ±5% | 0.70 |
| 7 | CL21C180JB61PN □ | | 18pF | 50 | ±5% | 0.70 |
| 8 | CL21C180JC61PN □ | | 18pF | 100 | ±5% | 0.70 |
| 9 | CL21C220JB61PN □ | | 22pF | 50 | ±5% | 0.70 |
| 10 | CL21C220JC61PN □ | | 22pF | 100 | ±5% | 0.70 |
| 11 | CL21C270JC61PN □ | | 27pF | 100 | ±5% | 0.70 |
| 12 | CL21C330JB61PN □ | | 33pF | 50 | ±5% | 0.70 |
| 13 | CL21C330JC61PN □ | | 33pF | 100 | ±5% | 0.70 |
| 14 | CL21C390JB61PN □ | | 39pF | 50 | ±5% | 0.70 |
| 15 | CL21C390JC61PN □ | | 39pF | 100 | ±5% | 0.70 |
| 16 | CL21C470JB61PN □ | | 47pF | 50 | ±5% | 0.70 |
| 17 | CL21C470JC61PN □ | | 47pF | 100 | ±5% | 0.70 |
| 18 | CL21C560JB61PN □ | | 56pF | 50 | ±5% | 0.70 |
| 19 | CL21C560JC61PN □ | | 56pF | 100 | ±5% | 0.70 |
| 20 | CL21C680JB61PN □ | | 68pF | 50 | ±5% | 0.70 |
| 21 | CL21C680JC61PN □ | | 68pF | 100 | ±5% | 0.70 |
| 22 | CL21C820JB61PN □ | | 82pF | 50 | ±5% | 0.70 |
| 23 | CL21C820JC61PN □ | | 82pF | 100 | ±5% | 0.70 |
| 24 | CL21C101JB61PN □ | | 100pF | 50 | ±5% | 0.70 |
| 25 | CL21C101JC61PN □ | | 100pF | 100 | ±5% | 0.70 |

※ □ mark means packaging code. If you want to learn the code or quantity in detail, please see p74.

- Part Numbering System
- Standard & High Capacitors
- Super Small Size Capacitors
- High-Q Capacitors
- Medium-High Voltage Capacitors
- Array Type Capacitors
- Low ESL Capacitors
- Reliability Test Condition
- Premium Capacitors for Automotive Applications
- Packaging Specification
- Application Manual for Surface Mounting



Product Lineup (Automotive Capacitors-COG)

| | Part Number | Size L x W (mm) | Capacitance | Rated Voltage (Vdc) | Capacitance Tolerance | Thickness Max.(mm) |
|----|------------------|--------------------|-------------|---------------------------|--------------------------|-----------------------|
| 26 | CL21C121JB61PN □ | 2.00×1.25 | 120pF | 50 | ±5% | 0.70 |
| 27 | CL21C121JC61PN □ | | 120pF | 100 | ±5% | 0.70 |
| 28 | CL21C151JB61PN □ | | 150pF | 50 | ±5% | 0.70 |
| 29 | CL21C151JC61PN □ | | 150pF | 100 | ±5% | 0.70 |
| 30 | CL21C221JB61PN □ | | 220pF | 50 | ±5% | 0.70 |
| 31 | CL21C221JC61PN □ | | 220pF | 100 | ±5% | 0.70 |
| 32 | CL21C271JB61PN □ | | 270pF | 50 | ±5% | 0.70 |
| 33 | CL21C271JC61PN □ | | 270pF | 100 | ±5% | 0.70 |
| 34 | CL21C331JB61PN □ | | 330pF | 50 | ±5% | 0.70 |
| 35 | CL21C331JC61PN □ | | 330pF | 100 | ±5% | 0.70 |
| 36 | CL21C471JBC1PN □ | | 470pF | 50 | ±5% | 0.95 |
| 37 | CL21C471JCC1PN □ | | 470pF | 100 | ±5% | 0.95 |
| 38 | CL21C561JBC1PN □ | | 560pF | 50 | ±5% | 0.95 |
| 39 | CL21C561JCC1PN □ | | 560pF | 100 | ±5% | 0.95 |
| 40 | CL21C681JBC1PN □ | | 680pF | 50 | ±5% | 0.95 |
| 41 | CL21C681JCC1PN □ | | 680pF | 100 | ±5% | 0.95 |
| 42 | CL21C821JBC1PN □ | | 820pF | 50 | ±5% | 0.95 |
| 43 | CL21C821JCC1PN □ | | 820pF | 100 | ±5% | 0.95 |
| 44 | CL21C102JBF1PN □ | | 1.0nF | 50 | ±5% | 1.35 |
| 45 | CL21C102JBC1PN □ | | 1.0nF | 50 | ±5% | 0.95 |
| 46 | CL21C102JCF1PN □ | | 1.0nF | 100 | ±5% | 1.35 |
| 47 | CL21C102JCC1PN □ | | 1.0nF | 100 | ±5% | 0.95 |
| 48 | CL21C122JBF1PN □ | | 1.2nF | 50 | ±5% | 1.35 |
| 49 | CL21C122JBC1PN □ | | 1.2nF | 50 | ±5% | 0.95 |
| 50 | CL21C152JBF1PN □ | | 1.5nF | 50 | ±5% | 1.35 |
| 51 | CL21C152JBC1PN □ | | 1.5nF | 50 | ±5% | 0.95 |
| 52 | CL21C182JBF1PN □ | | 1.8nF | 50 | ±5% | 1.35 |
| 53 | CL21C182JBC1PN □ | | 1.8nF | 50 | ±5% | 0.95 |
| 54 | CL21C222JBF1PN □ | | 2.2nF | 50 | ±5% | 1.35 |
| 55 | CL21C222JBC1PN □ | | 2.2nF | 50 | ±5% | 0.95 |
| 56 | CL21C272JBF1PN □ | | 2.7nF | 50 | ±5% | 1.35 |
| 57 | CL21C272JBC1PN □ | | 2.7nF | 50 | ±5% | 0.95 |
| 58 | CL21C332JBF1PN □ | | 3.3nF | 50 | ±5% | 1.35 |
| 59 | CL21C332JBC1PN □ | | 3.3nF | 50 | ±5% | 0.95 |
| 60 | CL21C392JBF1PN □ | | 3.9nF | 50 | ±5% | 1.35 |
| 61 | CL21C392JBC1PN □ | | 3.9nF | 50 | ±5% | 0.95 |
| 62 | CL21C472JBF1PN □ | | 4.7nF | 50 | ±5% | 1.35 |
| 63 | CL21C472JBC1PN □ | | 4.7nF | 50 | ±5% | 0.95 |
| 64 | CL21C562JBF1PN □ | | 5.6nF | 50 | ±5% | 1.35 |
| 65 | CL21C562JBC1PN □ | | 5.6nF | 50 | ±5% | 0.95 |
| 66 | CL21C682JBF1PN □ | | 6.8nF | 50 | ±5% | 1.35 |
| 67 | CL21C822JBF1PN □ | | 8.2nF | 50 | ±5% | 1.35 |
| 68 | CL21C103JBF1PN □ | | 10nF | 50 | ±5% | 1.35 |

※ □ mark means packaging code. If you want to learn the code or quantity in detail, please see p74.

Product Lineup (Automotive Capacitors-X7R)

| | Part Number | Size L x W (mm) | Capacitance | Rated Voltage (Vdc) | Capacitance Tolerance | Thickness Max.(mm) |
|----|------------------|--------------------|-------------|---------------------------|--------------------------|-----------------------|
| 1 | CL05B331KB5VPN □ | 1.00×0.50 | 330 pF | 50 | ±10% | 0.55 |
| 2 | CL05B471KB5VPN □ | | 470 pF | 50 | ±10% | 0.55 |
| 3 | CL05B681KB5VPN □ | | 680 pF | 50 | ±10% | 0.55 |
| 4 | CL05B102KA5VPN □ | | 1.0 nF | 25 | ±10% | 0.55 |
| 5 | CL05B102KB5VPN □ | | 1.0 nF | 50 | ±10% | 0.55 |
| 6 | CL05B152KA5VPN □ | | 1.5 nF | 25 | ±10% | 0.55 |
| 7 | CL05B152KB5VPN □ | | 1.5 nF | 50 | ±10% | 0.55 |
| 8 | CL05B222KA5VPN □ | | 2.2 nF | 25 | ±10% | 0.55 |
| 9 | CL05B222KB5VPN □ | | 2.2 nF | 50 | ±10% | 0.55 |
| 10 | CL05B332KA5VPN □ | | 3.3 nF | 25 | ±10% | 0.55 |
| 11 | CL05B332KB5VPN □ | | 3.3 nF | 50 | ±10% | 0.55 |
| 12 | CL05B472KA5VPN □ | | 4.7 nF | 25 | ±10% | 0.55 |
| 13 | CL05B472KB5VPN □ | | 4.7 nF | 50 | ±10% | 0.55 |
| 14 | CL05B682KA5VPN □ | | 6.8 nF | 25 | ±10% | 0.55 |
| 15 | CL05B682KB5VPN □ | | 6.8 nF | 50 | ±10% | 0.55 |
| 16 | CL05B103KA5VPN □ | | 10 nF | 25 | ±10% | 0.55 |
| 17 | CL05B103KB5VPN □ | | 10 nF | 50 | ±10% | 0.55 |
| 18 | CL05B153KA5VPN □ | | 15 nF | 25 | ±10% | 0.55 |
| 19 | CL05B153KB5VPN □ | | 15 nF | 50 | ±10% | 0.55 |
| 20 | CL05B223KA5VPN □ | | 22 nF | 25 | ±10% | 0.55 |
| 21 | CL05B223KB5VPN □ | | 22 nF | 50 | ±10% | 0.55 |
| 22 | CL05B333K05VPN □ | | 33 nF | 16 | ±10% | 0.55 |
| 23 | CL05B473K05VPN □ | | 47 nF | 16 | ±10% | 0.55 |
| 24 | CL05B683K05VPN □ | | 68 nF | 16 | ±10% | 0.55 |
| 25 | CL05B104K05VPN □ | | 100 nF | 16 | ±10% | 0.55 |

※ □ mark means packaging code. If you want to learn the code or quantity in detail, please see p74.

- Part Numbering System
- Standard & High Capacitors
- Super Small Size Capacitors
- High-Q Capacitors
- Medium-High Voltage Capacitors
- Array Type Capacitors
- Low ESL Capacitors
- Reliability Test Condition
- Premium Capacitors for Automotive Applications
- Packaging Specification
- Application Manual for Surface Mounting



Product Lineup (Automotive Capacitors-X7R)

| | Part Number | Size L x W (mm) | Capacitance | Rated Voltage (Vdc) | Capacitance Tolerance | Thickness Max.(mm) |
|----|------------------|--------------------|-------------|---------------------------|--------------------------|-----------------------|
| 1 | CL10B221KC8WPN □ | 1.60×0.80 | 220pF | 100 | ±10% | 0.90 |
| 2 | CL10B331KC8WPN □ | | 330pF | 100 | ±10% | 0.90 |
| 3 | CL10B471KC8WPN □ | | 470pF | 100 | ±10% | 0.90 |
| 4 | CL10B681KC8WPN □ | | 680pF | 100 | ±10% | 0.90 |
| 5 | CL10B102KB8WPN □ | | 1.0nF | 50 | ±10% | 0.90 |
| 6 | CL10B102KC8WPN □ | | 1.0nF | 100 | ±10% | 0.90 |
| 7 | CL10B152KB8WPN □ | | 1.5nF | 50 | ±10% | 0.90 |
| 8 | CL10B152KC8WPN □ | | 1.5nF | 100 | ±10% | 0.90 |
| 9 | CL10B222KB8WPN □ | | 2.2nF | 50 | ±10% | 0.90 |
| 10 | CL10B222KC8WPN □ | | 2.2nF | 100 | ±10% | 0.90 |
| 11 | CL10B332KB8WPN □ | | 3.3nF | 50 | ±10% | 0.90 |
| 12 | CL10B332KC8WPN □ | | 3.3nF | 100 | ±10% | 0.90 |
| 13 | CL10B472KB8WPN □ | | 4.7nF | 50 | ±10% | 0.90 |
| 14 | CL10B472KC8WPN □ | | 4.7nF | 100 | ±10% | 0.90 |
| 15 | CL10B682KB8WPN □ | | 6.8nF | 50 | ±10% | 0.90 |
| 16 | CL10B682KC8WPN □ | | 6.8nF | 100 | ±10% | 0.90 |
| 17 | CL10B103KB8WPN □ | | 10nF | 50 | ±10% | 0.90 |
| 18 | CL10B103KC8WPN □ | | 10nF | 100 | ±10% | 0.90 |
| 19 | CL10B153KB8WPN □ | | 15nF | 50 | ±10% | 0.90 |
| 20 | CL10B223KB8WPN □ | | 22nF | 50 | ±10% | 0.90 |
| 21 | CL10B333KA8WPN □ | | 33nF | 25 | ±10% | 0.90 |
| 22 | CL10B333KB8WPN □ | | 33nF | 50 | ±10% | 0.90 |
| 23 | CL10B473KA8WPN □ | | 47nF | 25 | ±10% | 0.90 |
| 24 | CL10B473KB8WPN □ | | 47nF | 50 | ±10% | 0.90 |
| 25 | CL10B683KA8WPN □ | | 68nF | 25 | ±10% | 0.90 |
| 26 | CL10B683KB8WPN □ | | 68nF | 50 | ±10% | 0.90 |
| 27 | CL10B104KA8WPN □ | | 100nF | 25 | ±10% | 0.90 |
| 28 | CL10B104KB8WPN □ | | 100nF | 50 | ±10% | 0.90 |
| 29 | CL10B154KO8VPN □ | | 150nF | 16 | ±10% | 0.90 |
| 30 | CL10B154KA8VPN □ | | 150nF | 25 | ±10% | 0.90 |
| 31 | CL10B224KO8VPN □ | | 220nF | 16 | ±10% | 0.90 |
| 32 | CL10B224KA8VPN □ | | 220nF | 25 | ±10% | 0.90 |
| 33 | CL10B334KO8VPN □ | | 330nF | 16 | ±10% | 0.90 |
| 34 | CL10B334KA8VPN □ | | 330nF | 25 | ±10% | 0.90 |
| 35 | CL10B474KO8VPN □ | | 470nF | 16 | ±10% | 0.90 |
| 36 | CL10B474KA8VPN □ | | 470nF | 25 | ±10% | 0.90 |
| 37 | CL10B684KO8VPN □ | | 680nF | 16 | ±10% | 0.90 |
| 38 | CL10B105KO8VPN □ | | 1.0μF | 16 | ±10% | 0.90 |

※ □ mark means packaging code. If you want to learn the code or quantity in detail, please see p74.

Product Lineup (Automotive Capacitors-X7R)

| | Part Number | Size L x W (mm) | Capacitance | Rated Voltage (Vdc) | Capacitance Tolerance | Thickness Max.(mm) |
|----|------------------|-----------------|-------------|---------------------|-----------------------|--------------------|
| 1 | CL21B102KC6WPN □ | 2.00×1.25 | 1.0 nF | 100 | ±10% | 0.70 |
| 2 | CL21B152KC6WPN □ | | 1.5 nF | 100 | ±10% | 0.70 |
| 3 | CL21B222KC6WPN □ | | 2.2 nF | 100 | ±10% | 0.70 |
| 4 | CL21B332KC6WPN □ | | 3.3 nF | 100 | ±10% | 0.70 |
| 5 | CL21B472KC6WPN □ | | 4.7 nF | 100 | ±10% | 0.70 |
| 6 | CL21B682KC6WPN □ | | 6.8 nF | 100 | ±10% | 0.70 |
| 7 | CL21B103KC6WPN □ | | 10 nF | 100 | ±10% | 0.70 |
| 8 | CL21B153KC6WPN □ | | 15 nF | 100 | ±10% | 0.70 |
| 9 | CL21B223KC6WPN □ | | 22 nF | 100 | ±10% | 0.70 |
| 10 | CL21B333KCCWPN □ | | 33 nF | 100 | ±10% | 0.95 |
| 11 | CL21B473KCCWPN □ | | 47 nF | 100 | ±10% | 0.95 |
| 12 | CL21B683KCCWPN □ | | 68 nF | 100 | ±10% | 0.95 |
| 13 | CL21B104KBFWPN □ | | 100 nF | 50 | ±10% | 1.35 |
| 14 | CL21B104KBCWPN □ | | 100 nF | 50 | ±10% | 0.95 |
| 15 | CL21B104KCFWPN □ | | 100 nF | 100 | ±10% | 1.35 |
| 16 | CL21B104KCCWPN □ | | 100 nF | 100 | ±10% | 0.95 |
| 17 | CL21B154KAFVFN □ | | 150 nF | 25 | ±10% | 1.35 |
| 18 | CL21B154KBFVFN □ | | 150 nF | 50 | ±10% | 1.35 |
| 19 | CL21B224KAFVFN □ | | 220 nF | 25 | ±10% | 1.35 |
| 20 | CL21B224KBFVFN □ | | 220 nF | 50 | ±10% | 1.35 |
| 21 | CL21B334KAFVFN □ | | 330 nF | 25 | ±10% | 1.35 |
| 22 | CL21B334KBFVFN □ | | 330 nF | 50 | ±10% | 1.35 |
| 23 | CL21B474KOFVFN □ | | 470 nF | 16 | ±10% | 1.35 |
| 24 | CL21B474KAFVFN □ | | 470 nF | 25 | ±10% | 1.35 |
| 25 | CL21B474KBFVFN □ | | 470 nF | 50 | ±10% | 1.35 |
| 26 | CL21B684KOFVFN □ | | 680 nF | 16 | ±10% | 1.35 |
| 27 | CL21B684KAFVFN □ | | 680 nF | 25 | ±10% | 1.35 |
| 28 | CL21B105KOFVFN □ | | 1.0 μF | 16 | ±10% | 1.35 |
| 29 | CL21B105KAFVFN □ | | 1.0 μF | 25 | ±10% | 1.35 |
| 30 | CL21B225KPFVFN □ | | 2.2 μF | 10 | ±10% | 1.35 |
| 31 | CL21B225KOFVFN □ | | 2.2 μF | 16 | ±10% | 1.35 |
| 32 | CL21B335KPQVFN □ | | 3.3 μF | 10 | ±10% | 1.40 |
| 33 | CL21B475KPQVFN □ | | 4.7 μF | 10 | ±10% | 1.40 |
| 1 | CL31B104KBPWPN □ | 3.20×1.60 | 100 nF | 50 | ±10% | 1.25 |
| 2 | CL31B104KBCVFN □ | | 100 nF | 50 | ±10% | 1.00 |
| 3 | CL31B154KBPWPN □ | | 150 nF | 50 | ±10% | 1.25 |
| 4 | CL31B224KBPWPN □ | | 220 nF | 50 | ±10% | 1.25 |
| 5 | CL31B334KBHWPN □ | | 330 nF | 50 | ±10% | 1.80 |
| 6 | CL31B474KBHWPN □ | | 470 nF | 50 | ±10% | 1.80 |
| 7 | CL31B684KBHWPN □ | | 680 nF | 50 | ±10% | 1.80 |
| 8 | CL31B105KAPWPN □ | | 1.0 μF | 25 | ±10% | 1.25 |
| 9 | CL31B105KBHWPN □ | | 1.0 μF | 50 | ±10% | 1.80 |
| 10 | CL31B155KAHVFN □ | | 1.5 μF | 25 | ±10% | 1.80 |
| 11 | CL31B155KBHVFN □ | | 1.5 μF | 50 | ±10% | 1.80 |
| 12 | CL31B225KOHVFN □ | | 2.2 μF | 16 | ±10% | 1.80 |
| 13 | CL31B225KAHVFN □ | | 2.2 μF | 25 | ±10% | 1.80 |
| 14 | CL31B225KBHVFN □ | | 2.2 μF | 50 | ±10% | 1.80 |
| 15 | CL31B335KOHVFN □ | | 3.3 μF | 16 | ±10% | 1.80 |
| 16 | CL31B335KAHVFN □ | | 3.3 μF | 25 | ±10% | 1.80 |
| 17 | CL31B475KOHVFN □ | | 4.7 μF | 16 | ±10% | 1.80 |
| 18 | CL31B475KAHVFN □ | | 4.7 μF | 25 | ±10% | 1.80 |
| 19 | CL31B685KOHVFN □ | | 6.8 μF | 16 | ±10% | 1.80 |
| 20 | CL31B106KOHVFN □ | | 10.0 μF | 16 | ±10% | 1.80 |
| 1 | CL32B226KOJVFN □ | 3.20×2.50 | 22 μF | 16 | ±10% | 2.70 |

- Part Numbering System
- Standard & High Capacitors
- Super Small Size Capacitors
- High-Q Capacitors
- Medium-High Voltage Capacitors
- Array Type Capacitors
- Low ESL Capacitors
- Reliability Test Condition
- Premium Capacitors for Automotive Applications
- Packaging Specification
- Application Manual for Surface Mounting

※ □ mark means packaging code. If you want to learn the code or quantity in detail, please see p74.



Reliability Test Condition (Automotive Capacitors)

| No | Item | Performance | Test Condition | | | | | | | | | | | | | | | |
|------|-------------------------------------|--|---|--|-----------------|------------|---|------------------------------|------------|---|------------|---|---|------------------------------|------------|---|------------|---|
| 1 | Pre-and Post-Stress Electrical Test | — | | | | | | | | | | | | | | | | |
| 2 | High Temperature Exposure | Appearance | No abnormal exterior appearance | | | | | | | | | | | | | | | |
| | | Capacitance Change | CLASS I | Within $\pm 2.5\%$ or $0.25\mu\text{F}$, (Whichever is larger) | | | | | | | | | | | | | | |
| | | | CLASS II | Within $\pm 10\%$ | | | | | | | | | | | | | | |
| | | Q | CLASS I | Capacitance $\geq 30\mu\text{F}$: $Q \geq 1,000$ $< 30\mu\text{F}$: $Q \geq 400 + 20 \times C$ (C : Capacitance) | | | | | | | | | | | | | | |
| | | Tan δ | CLASS II | Rated Voltage $\geq 25\text{V}$: 0.03 max $\geq 16\text{V}$: 0.05 max $\geq 10\text{V}$: 0.075 max *1) | | | | | | | | | | | | | | |
| IR | | More than $10,000\text{M}\Omega$ or $500\text{M}\Omega \times \mu\text{F}$ (Whichever is smaller) *1) | | | | | | | | | | | | | | | | |
| 3 | Temperature Cycling | Appearance | No abnormal exterior appearance | | | | | | | | | | | | | | | |
| | | Capacitance Change | CLASS I | Within $\pm 2.5\%$ or $0.25\mu\text{F}$, (Whichever is larger) | | | | | | | | | | | | | | |
| | | | CLASS II | Within $\pm 10\%$ | | | | | | | | | | | | | | |
| | | Q | CLASS I | Capacitance $\geq 30\mu\text{F}$: $Q \geq 1,000$ $< 30\mu\text{F}$: $Q \geq 400 + 20 \times C$ (C : Capacitance) | | | | | | | | | | | | | | |
| | | Tan δ | CLASS II | Rated Voltage $\geq 25\text{V}$: 0.03 max $\geq 16\text{V}$: 0.05 max $\geq 10\text{V}$: 0.075 max *1) | | | | | | | | | | | | | | |
| IR | | More than $10,000\text{M}\Omega$ or $500\text{M}\Omega \times \mu\text{F}$ (Whichever is smaller) *1) | | | | | | | | | | | | | | | | |
| | | | 1000Cycles | | | | | | | | | | | | | | | |
| | | | Initial Measurement | | | | | | | | | | | | | | | |
| | | | Final Measurement | | | | | | | | | | | | | | | |
| | | | Measurement at 24 ± 2 hrs after test conclusion | | | | | | | | | | | | | | | |
| | | | <table border="1"> <thead> <tr> <th>Step</th> <th>Temperature(°C)</th> <th>Time(min.)</th> </tr> </thead> <tbody> <tr> <td>1</td> <td>Min. operating Temp. ± 2</td> <td>15 ± 3</td> </tr> <tr> <td>2</td> <td>25 ± 2</td> <td>1</td> </tr> <tr> <td>3</td> <td>Max. operating Temp. ± 2</td> <td>15 ± 3</td> </tr> <tr> <td>4</td> <td>25 ± 2</td> <td>1</td> </tr> </tbody> </table> | Step | Temperature(°C) | Time(min.) | 1 | Min. operating Temp. ± 2 | 15 ± 3 | 2 | 25 ± 2 | 1 | 3 | Max. operating Temp. ± 2 | 15 ± 3 | 4 | 25 ± 2 | 1 |
| Step | Temperature(°C) | Time(min.) | | | | | | | | | | | | | | | | |
| 1 | Min. operating Temp. ± 2 | 15 ± 3 | | | | | | | | | | | | | | | | |
| 2 | 25 ± 2 | 1 | | | | | | | | | | | | | | | | |
| 3 | Max. operating Temp. ± 2 | 15 ± 3 | | | | | | | | | | | | | | | | |
| 4 | 25 ± 2 | 1 | | | | | | | | | | | | | | | | |
| 4 | Destructive Physical Analysis | No defects or abnormalities | Per EIA 469 | | | | | | | | | | | | | | | |
| 5 | Moisture Resistance | Appearance | No abnormal exterior appearance | | | | | | | | | | | | | | | |
| | | Capacitance Change | CLASS I | Within $\pm 2.5\%$ or $0.25\mu\text{F}$, (Whichever is larger) | | | | | | | | | | | | | | |
| | | | CLASS II | Within $\pm 12.5\%$ | | | | | | | | | | | | | | |
| | | Q | CLASS I | Capacitance $\geq 30\mu\text{F}$: $Q \geq 350$ $10 \leq \text{Capacitance} < 30\mu\text{F}$: $Q \geq 275 + (5/2) \times C$ Capacitance $< 10\mu\text{F}$: $Q \geq 200 + 10 \times C$ (C : Capacitance) | | | | | | | | | | | | | | |
| | | Tan δ | CLASS II | Rated Voltage $\geq 25\text{V}$: 0.03 max $\geq 16\text{V}$: 0.05 max $\geq 10\text{V}$: 0.075 max *1) | | | | | | | | | | | | | | |
| IR | | More than $10,000\text{M}\Omega$ or $500\text{M}\Omega \times \mu\text{F}$ (Whichever is smaller) *1) | | | | | | | | | | | | | | | | |
| | | | <p>10Cycles, $t=24$hrs/cycle Heat ($25\text{--}65^\circ\text{C}$) and humidity (80~98%), Unpowered measurement at 24 ± 2hrs after test conclusion</p> <p>The graph shows a temperature cycle from 25°C to 75°C. Humidity is 90-100% RH during the heating phase (3-7h, 9-11h, 13-15h) and 80-100% RH during the cooling phase (7-9h, 11-13h, 15-17h). The temperature is constant at 25°C from 17h to 24h.</p> | | | | | | | | | | | | | | | |

※ *1) : Indicates typical specification. Please refer to individual specifications.

| No | Item | Performance | Test Condition | |
|----|---------------------------------|--|---------------------------------|--|
| 6 | Biased Humidity | Appearance | No abnormal exterior appearance | |
| | | Capacitance Change | CLASS I | Within $\pm 2.5\%$ or $0.25\mu\text{F}$, (Whichever is larger) |
| | | | CLASS II | Within $\pm 12.5\%$ |
| | | Q | CLASS I | Capacitance $\geq 30\mu\text{F}$: $Q \geq 200$ $< 30\mu\text{F}$: $Q \geq 100 + (10/3) \times C$ (C : Capacitance) |
| | | Tan δ | CLASS II | Rated Voltage $\geq 25\text{V}$: 0.035 max $\geq 16\text{V}$: 0.05 max $\geq 10\text{V}$: 0.075 max *1) |
| IR | | More than $500\text{M}\Omega$ or $25\text{M}\Omega \times \mu\text{F}$ (Whichever is Smaller) *1) | | |
| 7 | High Temperature Operating Life | Appearance | No abnormal exterior appearance | |
| | | Capacitance Change | CLASS I | Within $\pm 3.0\%$ or $0.3\mu\text{F}$, (Whichever is larger) |
| | | | CLASS II | Within $\pm 12.5\%$ |
| | | Q | CLASS I | Capacitance $\geq 30\mu\text{F}$: $Q \geq 350$ $\geq 10\mu\text{F}$: $Q \geq 275 + (5/2) \times C$ $< 10\mu\text{F}$: $Q \geq 200 + 10 \times C$ (C : Capacitance) |
| | | Tan δ | CLASS II | Rated Voltage $\geq 25\text{V}$: 0.035 max $\geq 16\text{V}$: 0.05 max $\geq 10\text{V}$: 0.075 max *1) |
| IR | | More than $1,000\text{M}\Omega$ or $50\text{M}\Omega \times \mu\text{F}$ (Whichever is smaller) *1) | | |
| 8 | External Visual | No abnormal exterior appearance | Microscope (x10) | |
| 9 | Physical Dimensions | Within the specified dimensions | Using the calipers | |
| 10 | Mechanical Shock | Appearance | No abnormal exterior appearance | |
| | | Capacitance Change | CLASS I | Within $\pm 2.5\%$ or $0.25\mu\text{F}$, (Whichever is larger) |
| | | | CLASS II | Within $\pm 10\%$ |
| | | Q | CLASS I | Capacitance $\geq 30\mu\text{F}$: $Q \geq 1,000$ $< 30\mu\text{F}$: $Q \geq 400 + 20 \times C$ (C : Capacitance) |
| | | Tan δ | CLASS II | Rated Voltage $\geq 25\text{V}$: 0.025 max $\geq 16\text{V}$: 0.035 max $\geq 10\text{V}$: 0.05 max *1) |
| IR | | More than $10,000\text{M}\Omega$ or $500\text{M}\Omega \times \mu\text{F}$ (Whichever is smaller) *1) | | |

※ *1) : Indicates typical specification. Please refer to individual specifications.

*2) : Some of the parts are applicable in rated voltage 150%, Please refer to individual specifications.

- Part Numbering System
- Standard & High Capacitors
- Super Small Size Capacitors
- High-Q Capacitors
- Medium-High Voltage Capacitors
- Array Type Capacitors
- Low ESL Capacitors
- Reliability Test Condition
- Premium Capacitors for Automotive Applications
- Packaging Specification
- Application Manual for Surface Mounting



| No | Item | Performance | Test Condition | |
|----|---------------------------|--|---------------------------------|---|
| 11 | Vibration | Appearance | No abnormal exterior appearance | |
| | | Capacitance Change | CLASS I | Within $\pm 2.5\%$ or 0.25pF, (Whichever is larger) |
| | | | CLASS II | Within $\pm 10\%$ |
| | | Q | CLASS I | Capacitance $\geq 30\text{pF}$: $Q \geq 1,000$ < 30pF : $Q \geq 400+20 \times C$ (C : Capacitance) |
| | | Tan δ | CLASS II | Rated Voltage $\geq 25\text{V}$: 0.025 max $\geq 16\text{V}$: 0.035 max $\geq 10\text{V}$: 0.05max *1) |
| IR | | More than 10,000M Ω or 500M $\Omega \times \mu\text{F}$ (Whichever is smaller) *1) | | |
| 12 | Resistance to Solder Heat | Appearance | No abnormal exterior appearance | |
| | | Capacitance Change | CLASS I | Within $\pm 2.5\%$ or 0.25pF, (Whichever is larger) |
| | | | CLASS II | Within $\pm 10\%$ |
| | | Q | CLASS I | Capacitance $\geq 30\text{pF}$: $Q \geq 1,000$ < 30pF : $Q \geq 400+20 \times C$ (C : Capacitance) |
| | | Tan δ | CLASS II | Rated Voltage $\geq 25\text{V}$: 0.025 max $\geq 16\text{V}$: 0.035 max $\geq 10\text{V}$: 0.05max *1) |
| IR | | More than 10,000M Ω or 500M $\Omega \times \mu\text{F}$ (Whichever is smaller) *1) | | |
| 13 | Thermal Shock | Appearance | No abnormal exterior appearance | |
| | | Capacitance Change | CLASS I | Within $\pm 2.5\%$ or 0.25pF, (Whichever is larger) |
| | | | CLASS II | Within $\pm 10\%$ |
| | | Q | CLASS I | Capacitance $\geq 30\text{pF}$: $Q \geq 1,000$ < 30pF : $Q \geq 400+20 \times C$ (C : Capacitance) |
| | | Tan δ | CLASS II | Rated Voltage $\geq 25\text{V}$: 0.025 max $\geq 16\text{V}$: 0.035 max $\geq 10\text{V}$: 0.05max *1) |
| IR | | More than 10,000M Ω or 500M $\Omega \times \mu\text{F}$ (Whichever is smaller) *1) | | |
| 14 | ESD | Appearance | No abnormal exterior appearance | |
| | | Capacitance Change | CLASS I | Within $\pm 2.5\%$ or 0.25pF, (Whichever is larger) |
| | | | CLASS II | Within $\pm 10\%$ |
| | | Q | CLASS I | Capacitance $\geq 30\text{pF}$: $Q \geq 1,000$ < 30pF : $Q \geq 400+20 \times C$ (C : Capacitance) |
| | | Tan δ | CLASS II | Rated Voltage $\geq 25\text{V}$: 0.025 max $\geq 16\text{V}$: 0.035 max $\geq 10\text{V}$: 0.05max *1) |
| IR | | More than 10,000M Ω or 500M $\Omega \times \mu\text{F}$ (Whichever is smaller) *1) | | |

※ *1) : Indicates typical specification. Please refer to individual specifications.

| No | Item | Performance | Test Condition | | | | | | | | | | | | | | | | | | |
|---|---|---|---|--|-----------------|-----------|--------|---------|-------------------------|-----------|-----------|----------|-------------------------|-------------|----------|---------|-----------|-------------|---------|------------|-------------|
| 15 | Solderability | 95% of the terminations is to be soldered evenly and continuously | a) Preheat at 155°C for 4 hrs, Immerse in solder for 5s at 235±5°C b) Steam aging for 8 hrs, Immerse in solder for 5s at 235±5°C c) Steam aging for 8 hrs, Immerse in solder for 120s at 260±5°C solder : a solution ethanol and rosin | | | | | | | | | | | | | | | | | | |
| 16 | Electrical Characterization | Capacitance | Within specified tolerance | | | | | | | | | | | | | | | | | | |
| | | Q | CLASS I Capacitance ≥ 30pF : Q ≥ 1,000 < 30pF : Q ≥ 400+20×C (C : Capacitance) | | | | | | | | | | | | | | | | | | |
| | | Tanδ | CLASS II Rated Voltage ≥ 25V : 0.025 max ≥ 16V : 0.035 max ≥ 10V : 0.05max *1) | | | | | | | | | | | | | | | | | | |
| | | IR@25°C | CLASS I | More than 100,000MΩ or 1,000 MΩ × μF (Whichever is smaller) | | | | | | | | | | | | | | | | | |
| | | | CLASS II | More than 10,000MΩ or 500 MΩ × μF (Whichever is smaller) | | | | | | | | | | | | | | | | | |
| | | IR@125°C | CLASS I | More than 10,000MΩ or 100 MΩ × μF (Whichever is smaller) | | | | | | | | | | | | | | | | | |
| | | | CLASS II | More than 1,000MΩ or 10 MΩ × μF (Whichever is smaller) | | | | | | | | | | | | | | | | | |
| Dielectric Strength | No dielectric breakdown or mechanical breakdown | | | | | | | | | | | | | | | | | | | | |
| <p>The Capacitance /D.F. should be measured at 25°C, *A capacitor prior to measuring the capacitance is heat treated at 150+0/-10°C and maintained in ambient air for 24±2hrs.</p> <table border="1"> <thead> <tr> <th>Class</th> <th>Capacitance</th> <th>Frequency</th> <th>Vrms</th> </tr> </thead> <tbody> <tr> <td rowspan="2">Class I</td> <td>1000pF ↓</td> <td>1kHz ±10%</td> <td>0.5~5Vrms</td> </tr> <tr> <td>1000pF ↑</td> <td>1kHz ±10%</td> <td>1.0±0.2Vrms</td> </tr> <tr> <td rowspan="2">Class II</td> <td>10 μF ↓</td> <td>1kHz ±10%</td> <td>1.0±0.2Vrms</td> </tr> <tr> <td>10 μF ↑</td> <td>120Hz ±20%</td> <td>0.5±0.1Vrms</td> </tr> </tbody> </table> <p>Initial measurement Perform a heat treatment at 150+0/-10°C for one hour after soldering process. And then let sit for 24±2hrs at room temperature. Perform the initial measurement.</p> <p>I.R. should be measured with a DC voltage not exceeding Rated Voltage @25°C , @125°C for 60~120 sec.</p> <p>Dielectric Strength : 250% of the rated voltage for 1~5 seconds The charge/discharge current is less than 50mA.</p> | | | | Class | Capacitance | Frequency | Vrms | Class I | 1000pF ↓ | 1kHz ±10% | 0.5~5Vrms | 1000pF ↑ | 1kHz ±10% | 1.0±0.2Vrms | Class II | 10 μF ↓ | 1kHz ±10% | 1.0±0.2Vrms | 10 μF ↑ | 120Hz ±20% | 0.5±0.1Vrms |
| Class | Capacitance | Frequency | Vrms | | | | | | | | | | | | | | | | | | |
| Class I | 1000pF ↓ | 1kHz ±10% | 0.5~5Vrms | | | | | | | | | | | | | | | | | | |
| | 1000pF ↑ | 1kHz ±10% | 1.0±0.2Vrms | | | | | | | | | | | | | | | | | | |
| Class II | 10 μF ↓ | 1kHz ±10% | 1.0±0.2Vrms | | | | | | | | | | | | | | | | | | |
| | 10 μF ↑ | 120Hz ±20% | 0.5±0.1Vrms | | | | | | | | | | | | | | | | | | |
| 17 | Board Flex | Appearance | No abnormal exterior appearance | | | | | | | | | | | | | | | | | | |
| | | Capacitance Change | CLASS I Within ± 5.0% or 0.5pF, (Whichever is larger) | | | | | | | | | | | | | | | | | | |
| | | | CLASS II Within ± 10% | | | | | | | | | | | | | | | | | | |
| <p>Bending to the limit for 60 seconds Limit : Class I -3mm Class II - 3mm</p> <p>The figure indicates typical specification. Please refer to individual specifications Initial Measurement Perform a heat treatment at 150+0/-10°C for 1hr after soldering process. And then let sit for 24±2hrs at room temperature. Perform the initial measurement. Final measurement Let measure within 24hrs at room temperature after test conclusion.</p> | | | | | | | | | | | | | | | | | | | | | |
| 18 | Terminal Strength(SMD) | Appearance | No abnormal exterior appearance | | | | | | | | | | | | | | | | | | |
| | | Capacitance Change | CLASS I Within ± 2.5% or 0.25pF, (Whichever is larger) | | | | | | | | | | | | | | | | | | |
| | | | CLASS II Within ± 10% | | | | | | | | | | | | | | | | | | |
| <p>18N, for 60 ±1 sec. * 0603(1608) -10N, 0402(1005) -2N Initial Measurement Perform a heat treatment at 150+0/-10°C for 1hr after soldering process. And then let sit for 24±2hrs at room temperature. Perform the initial measurement. Final measurement Let measure within 24hrs at room temperature after test conclusion.</p> | | | | | | | | | | | | | | | | | | | | | |
| 19 | Beam Load | Destruction value should be exceed Chip Length ≤ 2.5mm a) Chip Thickness > 0.5mm : 20N b) Chip Thickness ≤ 0.5mm : 8N Chip Length ≥ 3.2mm a) Chip Thickness ≥ 1.25mm : 54.5N b) Chip Thickness < 1.25mm : 15N | Beam speed Chip Length ≤ 2.5mm , 0.5 ± 0.05mm/sec Chip Length ≥ 3.2mm , 2.5 ± 0.25mm/sec | | | | | | | | | | | | | | | | | | |
| 20 | Capacitance Temperature Characteristics | Capacitance Change | CLASS I | 0±30 ppm/°C | | | | | | | | | | | | | | | | | |
| | | | CLASS II | Within ± 15% | | | | | | | | | | | | | | | | | |
| | | Temperature Coefficient | CLASS I | 0±30 ppm/°C | | | | | | | | | | | | | | | | | |
| | | | CLASS I | Within ± 0.2% or 0.05pF, (Whichever is larger) | | | | | | | | | | | | | | | | | |
| | | Capacitance Drift | CLASS I | Within ± 0.2% or 0.05pF, (Whichever is larger) | | | | | | | | | | | | | | | | | |
| <table border="1"> <thead> <tr> <th>Step</th> <th>Temperature(°C)</th> </tr> </thead> <tbody> <tr> <td>1</td> <td>25 ± 2</td> </tr> <tr> <td>2</td> <td>Min. Operating Temp. ±2</td> </tr> <tr> <td>3</td> <td>25 ± 2</td> </tr> <tr> <td>4</td> <td>Max. Operating Temp. ±2</td> </tr> <tr> <td>5</td> <td>25 ± 2</td> </tr> </tbody> </table> | | | | Step | Temperature(°C) | 1 | 25 ± 2 | 2 | Min. Operating Temp. ±2 | 3 | 25 ± 2 | 4 | Max. Operating Temp. ±2 | 5 | 25 ± 2 | | | | | | |
| Step | Temperature(°C) | | | | | | | | | | | | | | | | | | | | |
| 1 | 25 ± 2 | | | | | | | | | | | | | | | | | | | | |
| 2 | Min. Operating Temp. ±2 | | | | | | | | | | | | | | | | | | | | |
| 3 | 25 ± 2 | | | | | | | | | | | | | | | | | | | | |
| 4 | Max. Operating Temp. ±2 | | | | | | | | | | | | | | | | | | | | |
| 5 | 25 ± 2 | | | | | | | | | | | | | | | | | | | | |

※ *1) : Indicates typical specification. Please refer to individual specifications.

*If you want more detailed information, Please Visit Samsung Electro-mechanics website (www.semclcr.com)

- Part Numbering System
- Standard & High Capacitors
- Super Small Size Capacitors
- High-Q Capacitors
- Medium-High Voltage Capacitors
- Array Type Capacitors
- Low ESL Capacitors
- Reliability Test Condition
- Premium Capacitors for Automotive Applications
- Packaging Specification
- Application Manual for Surface Mounting

Cardboard Paper Tape(4mm)



Unit: inch(mm)

| Symbol Type | | A | B | W | F | E | P1 | P2 | P0 | D | t |
|-------------|----------------------------|-------------|-------------|-------------|--------------|--------------|-------------|--------------|-------------|-----------------|--------------|
| Dimension | 0504 (1410) | 1.3 ±0.2 | 1.7 ±0.2 | 8.0 ±0.3 | 3.5 ±0.05 | 1.75 ±0.1 | 4.0 ±0.1 | 2.0 ±0.05 | 4.0 ±0.1 | Ø1.5 +0.1/-0 | 1.1 Below |
| | 0603 0306 (1608) (0816) | 1.1 ±0.2 | 1.9 ±0.2 | | | | | | | | |
| | 0805 0508 (2012) (1220) | 1.6 ±0.2 | 2.4 ±0.2 | | | | | | | | |
| | 1206 0612 (3216) (1632) | 2.0 ±0.2 | 3.6 ±0.2 | | | | | | | | |

Cardboard Paper Tape(2mm)



Unit: inch(mm)

| Symbol Type | | A | B | W | F | E | P1 | P2 | P0 | D | t |
|-------------|-----------------|-------------------------|-------------------------|-------------|--------------|--------------|--------------|--------------|-------------|------------------------|---------------|
| Dimension | 01005 (0402) | 0.25 ±0.02 | 0.45 ±0.02 | 8.0 ±0.3 | 3.5 ±0.05 | 1.75 ±0.1 | 2.0 ±0.05 | 2.0 ±0.05 | 4.0 ±0.1 | Ø1.5 +0.1 /-0.03 | 0.25 ±0.02 |
| | 0201 (0603) | 0.38 ±0.03 | 0.68 ±0.03 | | | | | | | | 0.37 ±0.03 |
| | 0402 (1005) | 0.62 ±0.05 | 1.12 ±0.05 | | | | | | | | 0.37 ±0.05 |
| | | | | | | | | | | | 0.60 ±0.05 |
| | 0204 (0510) | 0.62 +0.05 /-0.10 | 1.12 +0.05 /-0.10 | | | | | | | | 0.37 ±0.03 |

Embossed Plastic Tape



Unit: inch(mm)

| Symbol Type | A | B | W | F | E | P1 | P2 | P0 | D | t1 | t0 |
|--------------|-------------------------|-------------------------|--------------|---------------|--------------|--------------|--------------|--------------|------------------------|---------------|--------------|
| 01005 (0402) | 0.25 ±0.02 | 0.45 ±0.02 | 4.0 ±0.05 | 1.8 ±0.02 | 0.9 ±0.05 | 1.0 ±0.02 | 1.0 ±0.02 | 2.0 ±0.04 | ∅0.8 ±0.04 | 0.25 ±0.02 | 0.5 max |
| 0603 (1608) | 1.05 ±0.15 | 1.9 ±0.15 | 8.0 ±0.3 | 3.5 ±0.05 | 1.75 ±0.1 | 4.0 ±0.1 | 2.0 ±0.05 | 4.0 ±0.1 | ∅1.5 +0.1/ -0.03 | 2.9 max | 0.6 Below |
| 0805 (2012) | 1.45 ±0.2 | 2.3 ±0.2 | | | | | | | | | |
| 1206 (3216) | 1.9 ±0.2 | 3.5 ±0.2 | | | | | | | | | |
| 1210 (3225) | 2.8 ±0.2 | 3.6 ±0.2 | | | | | | | | | |
| 1808 (4520) | 2.3 ±0.2 | 4.9 ±0.2 | | | | | | | | | |
| 1812 (4532) | 3.6 ±0.2 | 4.9 ±0.2 | 12.0 ±0.3 | 5.60 ±0.05 | 8.0 ±0.1 | 3.8 max | | | | | |
| 2220 (5750) | 5.5 ±0.2 | 6.2 ±0.2 | 0.8 ±0.3 | 3.5 ±0.05 | 4.0 ±0.1 | 2.5 max | | | | | |
| 0204 (5010) | 0.62 +0.05 /-0.10 | 1.12 +0.05 /-0.10 | | | | | | | | | |
| 0306 (0816) | 1.1 ±0.2 | 1.9 ±0.2 | | | | | | | | | |
| 0508 (1220) | 1.45 ±0.2 | 2.3 ±0.2 | | | | | | | | | |
| 0612 (1632) | 2.0 ±0.2 | 3.6 ±0.2 | | | | | | | | | |

Part Numbering System

Standard & High Capacitors

Super Small Size Capacitors

High-Q Capacitors

Medium-High Voltage Capacitors

Array Type Capacitors

Low ESL Capacitors

Reliability Test Condition

Premium Capacitors for Automotive Applications

Packaging Specification

Application Manual for Surface Mounting

Peeling off of Cover Tape

- 10 g.f ≤ Peel off force ≤ 70 g.f

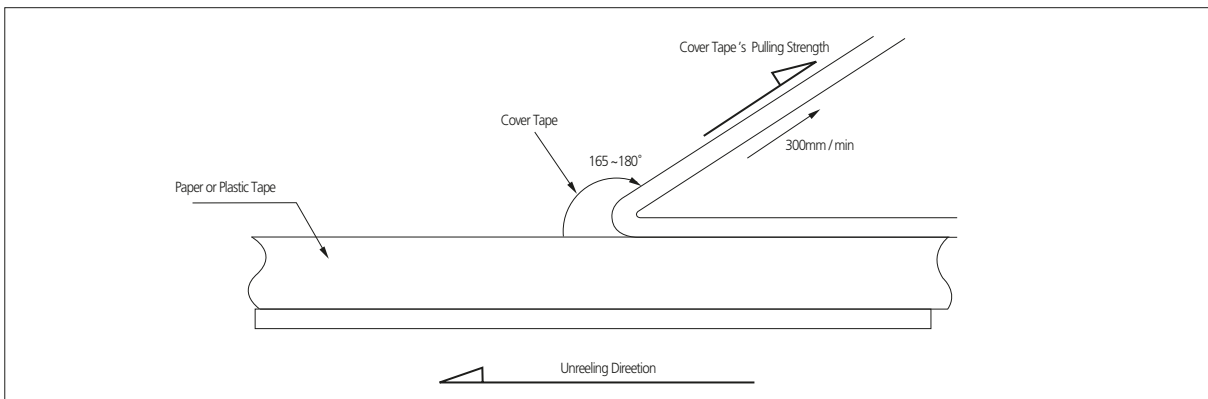

Reel Dimensions



Unit: mm

| Symbol | Tape Width | A | B | C | D |
|----------|------------|--------------------------|-------------------------|-------------------------|------------|
| 7" Reel | 8mm | $\varnothing 180+0/-3$ | $\varnothing 60\pm 1.0$ | $\varnothing 13\pm 0.3$ | 4 ± 0.2 |
| | 12mm | $\varnothing 180+0/-3$ | $\varnothing 60+1/-0$ | $\varnothing 13\pm 0.3$ | 4 ± 0.2 |
| 10" Reel | 8mm | $\varnothing 258+0/-3$ | $\varnothing 80+1/-0$ | $\varnothing 13\pm 0.3$ | 4 ± 0.2 |
| | 12mm | $\varnothing 258+0/-3$ | $\varnothing 80+1/-0$ | $\varnothing 13\pm 0.3$ | 4 ± 0.2 |
| 13" Reel | 8mm | $\varnothing 330\pm 2.0$ | $\varnothing 80\pm 1.0$ | $\varnothing 13\pm 0.3$ | 4 ± 0.2 |
| | 12mm | $\varnothing 330\pm 2.0$ | $\varnothing 80\pm 1.0$ | $\varnothing 13\pm 0.3$ | 4 ± 0.2 |

| Symbol | Tape Width | E | W | t |
|----------|------------|--------------|-------------|--------------|
| 7" Reel | 8mm | 2.0 ± 0.5 | 9 ± 0.5 | 1.2 ± 0.2 |
| | 12mm | 2.0 ± 0.5 | 13 ± 0.5 | 1.2 ± 0.2 |
| 10" Reel | 8mm | 2.0 ± 0.5 | 9 ± 0.5 | 1.8 ± 0.2 |
| | 12mm | 2.0 ± 0.5 | 13 ± 0.5 | 1.8 ± 0.2 |
| 13" Reel | 8mm | 2.0 ± 0.5 | 9 ± 0.5 | 2.2 ± 0.2 |
| | 12mm | 2.0 ± 0.5 | 13 ± 0.5 | 2.2 ± 0.2 |

Part Numbering System

Standard & High Capacitors

Super Small Size Capacitors

High-Q Capacitors

Medium-High Voltage Capacitors

Array Type Capacitors

Low ESL Capacitors

Reliability Test Condition

Premium Capacitors for Automotive Applications

Packaging Specification

Application Manual for Surface Mounting

Bulk Case Packaging

- Bulk case packaging can reduce the stock space and transportation costs.
- The bulk feeding system can increase the productivity.
- It can eliminate the components loss.



Unit: mm

| Symbol | A | B | T | C | D | E |
|-----------|--------------|--------------|-------------|--------------|------------|--------------|
| Dimension | 6.8 ± 0.1 | 8.8 ± 0.1 | 12 ± 0.1 | $1.5+0.1/-0$ | $2+0/-0.1$ | $3.0+0.2/-0$ |

| Symbol | F | W | G | H | L | I |
|-----------|---------------|-------------|--------------|-------------|--------------|-------------|
| Dimension | $31.5+0.2/-0$ | $36+0/-0.2$ | 19 ± 0.35 | 7 ± 0.35 | 110 ± 0.7 | 5 ± 0.35 |

• QUANTITY

Unit: inch(mm) and pcs

| Size | 0402(1005) | 0603(1608) | 0805(2012) | |
|----------|------------|------------------|------------|---------|
| | | | T≤0.85mm | T≥1.0mm |
| Quantity | 50,000 | 10,000 or 15,000 | 10,000 | 5,000 |

Application Manual for Surface Mounting

1.Storage of products

1-1. Storage Environment

Tape packing materials are designed to withstand long-term storage, but they will degrade more rapidly in the presence of high temperature or high humidity. Therefore, the products must be stored in an ambient 5~40°C with a relative humidity of 20~70%. Allowable storage period is within 6 months from the outgoing date of delivery.

1-2. Corrosive Gases

Since sulfur and chlorine may degrade the solderability of the end termination, it is important to store the capacitors in an environment free of these gases.

1-3. Temperature Fluctuations

Since dew condensation may occur by the differences in temperature when the products are taken out of storage, it is important to maintain a temperature-controlled environment.

2.Design of Solder Land Pattern

When designing printed circuit boards, the shape and size of the solder lands must allow for the proper amount of solder on the capacitor. The amount of solder at the end terminations has a direct effect on the probability that the chip will crack. The greater amount of solder, the larger amount of stress on the chip, and the more likely that it will break. Use the following illustrations as guidelines for proper Solder land design.

Recommendation of solder Land Shape and Size



3.Adhesives

MLCCs generally require the use of an adhesive to position the chips to the circuit board prior to soldering.

3-1. Requirements for Adhesives

They must have enough adhesion so that the chips will not fall off or move during the handling of the circuit board.

They must maintain their adhesive strength when exposed to soldering temperatures.

They should not spread or run when applied to the circuit board.

They should have a long pot life.

They should harden quickly.

They should not corrode the circuit board or chip material.

They should be a good insulator.

They should be non-toxic, and not produce harmful gases, nor be harmful when touched.

3-2. Application Method

It is important to use the proper amount of adhesive. Too little will cause poor adhesion to the circuit board, and too much may strain the conductor pattern, thereby causing defective soldering. The following illustrations show the proper quantity of adhesive.



| Unit: mm | | |
|----------|-----------|-----------|
| Type | 21 | 31 |
| a | 0.2min | 0.2min |
| b | 70~100 μm | 70~100 μm |
| c | >0 | >0 |

3-3. Adhesive hardening Characteristics

To prevent oxidation of the terminations, the adhesive must harden at 160°C or less, within 2 minutes or less.

4. Mounting

4-1. Mounting Head Pressure

Excessive pressure will cause chip capacitors to crack. The pressure between nozzle and chip capacitor will be 300g maximum during mounting.

4-2. Bending Stress

Bending of printed circuit board by mounting head when double-sided circuit boards are used, chip capacitors first are mounted and soldered onto one side of the board. When the capacitors are mounted onto the other side, it is important to support the board as shown in the illustration. If the circuit board is not supported, it may bend, causing the already-installed capacitors to crack.



5. Flux

Although highly-activated flux gives better solderability, substances which increase activity may also degrade the insulation of the chip capacitors. To avoid such degradation, it is recommended that a mildly activated rosin flux (less than 0.2% chlorine) be used.

6. Soldering

Since a multilayer ceramic chip capacitor comes into direct contact with melted solder during soldering, it is exposed to potentially mechanical stress caused by the sudden temperature change. The capacitor may also be subject to silver migration, and to contamination by the flux. Because of these factors, soldering technique is critical.

6-1. Soldering Methods

| Method | Classification | |
|------------------|--------------------------------|---|
| Reflow soldering | · Overall heating | · Infrared rays · Hot plate · VPS (Vapor phase) |
| | · Local heating | · Air heater · Laser · Light beam |
| Flow soldering | · Single wave · Double wave | |

6-2. Soldering Profile

To avoid the crack problem by sudden temperature change, follow the temperature profile in the adjacent graph.

Part Numbering System

Standard & High Capacitors

Super Small Size Capacitors

High-Q Capacitors

Medium-High Voltage Capacitors

Array Type Capacitors

Low ESL Capacitors

Reliability Test Condition

Premium Capacitors for Automotive Applications

Packaging Specification

Application Manual for Surface Mounting

6-2-1 Pb-Free (Sn 100%) Plating

▪ **REFLOW SOLDERING**



| Soldering Temp. (°C) | Pre-heating Time (①, sec.) | Soldering Time (②, sec.) |
|----------------------|----------------------------|--------------------------|
| 260+0/-5°C | 60~120 | 60~150 |

▪ **FLOW SOLDERING**



| ΔT (°C) | Soldering Temp. (°C) | Pre-heating Time (①+②, sec.) | Soldering Time (③, sec.) |
|-------------------------------------|----------------------|------------------------------|--------------------------|
| ≤ 150 (1206 and below size) | 260±3 | ≥ 120 | ≤ 5 |

▪ **SOLDER IRON(Hand Soldering)**

| Variation of Temp.(°C) | Soldering Temp(°C) | Pre-heating Time(sec.) | Soldering Time(sec.) | Cooling Time(sec.) | Condition of Iron Facilities | | |
|------------------------|--------------------|------------------------|----------------------|--------------------|------------------------------|--------------|----------------|
| | | | | | Wattage | Tip Diameter | Soldering Time |
| $\Delta T \leq 130$ | 300±10°C max. | ≥ 60 sec. | ≤ 4 sec. | — | 20W max. | 3mm max. | 4 sec max. |

※ Caution - Iron tip should not contact with ceramic body directly

6-3. Manual Soldering

Manual soldering can pose a great risk of creating thermal cracks in chip capacitors. The hot soldering iron tip comes into direct contact with the end terminations, and operator's carelessness may cause the tip of the soldering iron to come into direct contact with the ceramic body of the capacitor. Therefore the soldering iron must be handled carefully, and close attention must be paid to the selection of the soldering iron tip and to temperature control of the tip.

6-4. Amount of Solder

| | | |
|-------------------|--|--|
| Too much Solder | | Cracks tend to occur due to large stress. |
| Not enough solder | | Weak holding force may cause bad connections or detaching of the capacitor |

6-5. Cooling

Natural cooling using air is recommended. If the chips are dipped into solvent for cleaning, the temperature difference (ΔT) must be less than 100°C

6-6. Cleaning

If rosin flux is used, cleaning usually is unnecessary. When strongly activated flux is used, chlorine in the flux may dissolve into some types of cleaning fluids, thereby affecting the chip capacitors. This means that the cleaning fluid must be carefully selected, and should always be new.

7. Notes for Separating Multiple, Shared PC Boards

A multi-PC board is separated into many individual circuit boards after soldering has been completed. If the board is bent or distorted at the time of separation, cracks may occur in the chip capacitors. Carefully choose a separation method that minimizes the bending of the circuit board.

Part Numbering System

Standard & High Capacitors

Super Small Size Capacitors

High-Q Capacitors

Medium-High Voltage Capacitors

Array Type Capacitors

Low ESL Capacitors

Reliability Test Condition

Premium Capacitors for Automotive Applications

Packaging Specification

Application Manual for Surface Mounting

 **Attention**

1. This catalogue is valid only to the products purchased either from us or through our official distributors.
2. Product specifications included in this catalogue are effective as of Nov 1, 2015.
Please be advised that they are standard product specifications for reference only.
We may change, modify or discontinue the product specifications without notice at any time.
So, you need to approve the product specifications before placing an order. Should you have any question regarding our product specifications, please contact our sales personnel or application engineers.
3. We may modify or cease to produce the products listed in this catalogue without notice. Should you have any question, please contact our sales personnel or application engineers.
4. Without obtaining our permission, you should not be allowed to reproduce, copy, use or transfer any content or information contained this catalogue in any manner whatsoever for any purpose.
5. In no event, will we be responsible for any claim, dispute, damage or liability whatsoever arising from, relating to or in connection with your misuse of the products or/and information included in this catalogue.
We will also not assume any responsibilities whatsoever for any claim, dispute, damage or liability with regards to the intellectual property rights or other related rights of ours or any third party associated with your use of our products and/or information contained in this catalogue. We expressly disclaim that no license is granted regarding the aforementioned rights.
6. Please note that the products in this catalogue are not designed or intended to use for the applications set forth below. So, if you intend to use the products in this catalogue for the applications listed below, you should contact our sales personnel or application engineers before using.
Please be aware that any misuse of the products deviating from product specifications or information provided in this catalogue may cause a serious property damage or a personal injury.
 - ① Aerospace/Aviation equipment
 - ② Transportation equipment (vehicles, trains, ships, etc)
 - ③ Medical equipment
 - ④ Military equipment
 - ⑤ Disaster prevention/crime prevention equipment
 - ⑥ Any other applications with the same as or similar complexity or reliability to the applications set forth above.

Certifications

ISO/TS 16949



ISO 14001



OHSAS18001



Sony Green Partner



QC 080000 IECQ HSPM



Quality System Certification status for each factory site

| Certification | Suwon (Korea) | Busan (Korea) | Calamba (Philippines) | Tianjin (China) | Binhai (China) |
|---|-------------------------------|-------------------------------|----------------------------------|-------------------------------|-------------------------------|
| ISO / TS 16949 | BSI TS 91430 - 000 | BSI TS 91430 - 001 | BSI TS 91430 - 005 | BSI TS 91430 - 007 | BSI TS 91430 - 007 |
| Date Validity | 2013-10-25 ~2016-10-24 | 2013-08-08 ~2016-08-07 | 2012-08-03 ~2015-08-02 | 2011-11-29 ~2014-11-28 | 2011-11-29 ~2014-11-28 |
| ISO 14001 | BSI EMS 599427 | BSI EMS 599427 | BSI EMS 77354 | BSI EMS 585363 | BSI EMS 585363 |
| Date Validity | 2013-06-25 ~2016-06-24 | 2013-06-25 ~2016-06-24 | 2012-07-13 ~2015-07-12 | 2012-04-17 ~2015-04-16 | 2012-04-17 ~2015-04-16 |
| OHSAS 18001 | BSI OHS 599428 | BSI OHS 599428 | BSI OHS 568723 | BSI OHS 585364 | BSI OHS 585364 |
| Date Validity | 2013-06-25 ~2016-06-24 | 2013-06-25 ~2016-06-24 | 2013-10-14 ~2016-10-13 | 2012-04-17 ~2015-04-16 | 2012-04-17 ~2015-04-16 |
| Sony Green Partner Date Validity | 2012-06-01 ~2014-05-31 | 2012-06-01 ~2014-05-31 | 2012-06-01 ~2014-05-31 | 2012-06-01 ~2014-05-31 | 2012-06-01 ~2014-05-31 |
| QC 080000 | UL KR-HSPM-1011 | UL KR-HSPM-1012 | UL PI-HSPM-1001 | UL PRC-HSPM-1767 | UL PRC-HSPM-1767-2 |
| Date Validity | 2013-06-17 ~2016-07-01 | 2013-06-27 ~2016-07-19 | 2013-06-27 ~2016-07-04 | 2013-07-08 ~2016-07-26 | 2013-07-08 ~2016-07-26 |

Note



Passive components sales offices

• Head office

150, Meayoungro(Maetan-dong)
Yeongtong-gu, Suwon-city,
Gyeonggi province, Korea,443-743
Tel : +82-31-210-5114

Europe

Tel : +82-31-210 -6328
E-mail : james.pyun@samsung.com

America

Tel : +82-31-210 -6803
E-mail : wesley.roh@samsung.com

China

Tel : +82-31-210-3476
E-mail : james.h.lee@samsung.com

Japan

Tel : +82-31-210-6304
E-mail : jdkim1@samsung.com

Domestic

Tel : +82-31-210-3692
E-mail : jeongki.um@samsung.com

• Manufacturing sites

Suwon Plant(Korea)

150,Meayoungro(Maetan-dong)
Yeongtong-gu, Suwon-city,
Gyeonggi province, Korea,443-743
Tel : +82-31-210-5114

Busan Plant (Korea)

333,Noksan Sanupjoongro(Songjeong-
dong,)Gangseo-gu, Busan, Korea,
618-270
Tel : +82-51-970-7114

Tianjin Plant (China)

27, Heiniucheng-Road,Tianjin,
China 300210
Tel : +86-22-2830-3333

Binhai Plant(China)

No 80 xiaqing road,
TEDA west District, China
Tel : +86-22-6686-3333

Philippines Plant (Philippines)

Block 5 Calamba Premiere Industrial Park
Calamba City, Philippines
Tel : +63-49-508-8311

• Asia sales offices

Shenzhen office

46 F, New World Center, Yitian Road, Futian
District,Shenzhen, China 518026
Tel : +86-755-8608-5579
E-mail : andy.li@samsung.com

Shanghai office

Rm. 1211, Shanghai International Trade
CenterNo.2201 Yan An(W) Rd., Shanghai, China
200335
Tel : +86-21-2231-4341
E-mail : koogil@samsung.com

Beijing office

12/F China Merchants Tower No. 118, Jian Guo
Lu, Chao Yang District, Beijing, China
Tel : +86-10-6566-8100-6606
E-mail : kiko.wang@samsung.com

Qingdao Office

Rm 1201. Growne Plaza Qingdao 76,
Xiang Gang Zhong Rd, Qingdao,
266071 China
Tel : +86-532-85779102
E-mail : zhengguo.cui@samsung.com

Taipei Office

9F-1, Np. 399 Ruey Kuang Rd., Neihu
District, Taipei City, Taiwan, 114
Tel : +886-2-2656-8350
E-mail : kevin0130.wang@samsung.com

Singapore office

Samsung Electro-Mechanics Private LimitedP
3 Church Street Samsung Hub #23-01
Singapore 049483
Tel : +65-6933-2630
E-mail : alvin.koh@samsung.com

Bangkok office

24180 Wellgrow Industrial Estate, 93 Moo 5,
Bangsamak A. Bangpakong, Chachoensao,
Thailand
Tel : +66-38-562-110
E-mail : kyunghoon1.lee@samsung.com

Japan office

108-0075 Minato-ku Tokyo Kounan 2-16-4
Shinagawa Grand Cnetral Tower 9F, Japan
Tel : +81-3-6369-6452
E-mail : hikota.suga@samsung.com

• America sales office

Irvine office

3333 Michelson Drive, Suite 500, Irvine, CA
92612, USA
Tel : +1-949-797-8016
E-mail : andrew.skelly@samsung.com

San Jose office

601, McCarthy Blvd., San Jose, CA 95035, USA
Tel : +1-408-544-4552
E-mail : jay.pauer@samsung.com

Chicago office

1870 West Winchester Rd, Suite 247,
Libertyville IL 60048, USA
Tel : +1-847-549-9424
E-mail : sweety@samsung.com

• Europe sales offices

Frankfurt office

Samsung, Haus, Am Kronberger Hang 6,
D-65824 Schwalbach/Ts. Germany
Tel : +49-6196-66-7255
E-mail : frank.goebel@samsung.com

London office

KT130NY 2nd floor, No 5. No 5. The Heights,
Brooklands, Weybridge Surrey, England
Tel : +44-1932-826-811
E-mail : river.lee@samsung.com

Helsinki office

02600, Lars Sonckin Kaari 14, Espoo, Finland
Tel : +358-9-853-1132
E-mail : jouni.riuttanen@samsung.com

• Domestic Distributors

Korchip Corporation

359, Manan-ro, Manan-gu, Anyang-si,
Gyeonggi-do, Korea
Tel : +82-31-361-8100
E-mail : parts@korchip.com

SAMT

315, Yeongdong-daero, Gangnam-gu, Seoul,
Korea
Tel : +82-2-3458-9000
E-mail : info@samt.com

CHUNGMAC

40-3, Gokseon-ro 49beon-gil, Gwonseon-gu,
Suwon-si, Gyeonggi-do, Korea
Tel : +82-31-234-2367
E-mail : webmaster@chungmac.co.kr

YOUNGDUK

632, Seobusaet-gil, Geumcheon-gu, Seoul,
Korea
Tel : +82-2-2107-7860
E-mail : dryblood@hanmail.net

All information indicated in this catalog is as of November. 2015

* The specifications and designs contained herein may be subject to change without notice.

X-ON Electronics

Largest Supplier of Electrical and Electronic Components

Click to view similar products for [samsung manufacturer](#):

Other Similar products are found below :

[DA61-04475B](#) [DA97-17194A](#) [RC2012F2001CS](#) [KM44C4100BK-60](#) [CL05C160JB5NCNC](#) [CL21C151FBANNWC](#) [M471B5673EH1-CH900](#)
[K4H510838B-TCB3](#) [RC1608F86R6CS](#) [CL31C120JBCNNNC](#) [CL21CR47BBANNNC](#) [CL10B104JO8NNNC](#) [CL32C103JBFNNNE](#)
[CL31B223JBCNNNC](#) [CL21C221JDCNFNC](#) [CL21B223KBANNWC](#) [CL10B563KB8NFNC](#) [CL10B473KB8SFNC](#) [CL10B122KB8NFNC](#) [SI-](#)
[B8T171550WW](#) [SL-B8V2N70LAWW](#) [BN96-35590A](#) [BN96-31876D](#) [DC97-15103A](#) [DA67-02638B](#) [BN96-32239D](#) [BN39-02189A](#) [BN39-](#)
[02190A](#) [DA61-08574A](#) [DA97-17215A](#) [DC47-00027F](#) [AH59-02748B](#) [3903-001209](#) [RF062PJ150CS](#) [CL10A335MQ8NNNC](#)
[CL10B823KA8NNNC](#) [CL10C680JB8NFNC](#) [CL31B681KHFNFNE](#) [CL31C101JCCNFNC](#) [RC1608F753CS](#) [RC1005FR100CS](#)
[CL10F334ZO8NNNC](#) [CL31C331KBCNBNC](#) [CL31B683KBCNNNC](#) [CL21C2R4CBANNNC](#) [CL05B104MP5NNNC](#) [DC97-16350E](#) [AH81-](#)
[09068A](#) [DC66-00814A](#) [DC61-03981A](#)