

(2.54 mm) .100"

BCS SERIES

TIGER CLAW™ PASS-THROUGH SOCKET

Mates with:
 TSW, MTSW, HTSW,
 HMTSW, TSS, ZSS,
 DW, EW, ZW, HW, TSM,
 MTLW, PHT

SPECIFICATIONS

For complete specifications see www.samtec.com?BCS

Insulator Material:
 Black Liquid Crystal Polymer
Contact Material:
 Phosphor Bronze
Plating:
 Au or Sn over
 50 μm (1.27 μm) Ni
Current Rating (BCS/TSW):
 4.6 A per pin
 (2 pins powered)
Voltage Rating:
 475 VAC
 (-TE/-DE/-PE mated with TSM)
 450 VAC
 (-HE mated with TSW)
Operating Temp Range:
 -55 °C to +125 °C
Insertion Depth:
 (4.34 mm) .171" to (7.24 mm)
 .285" from top, (5.64 mm)
 .222" plus board thickness
 minimum from bottom.
 -HE is (4.34 mm) .171"
 to (6.35 mm) .250"
RoHS Compliant:
 Yes
Lead-Free Solderable:
 Yes

RECOGNITIONS

For complete scope of recognitions see www.samtec.com/quality



ALSO AVAILABLE (MOQ Required)

- Other platings

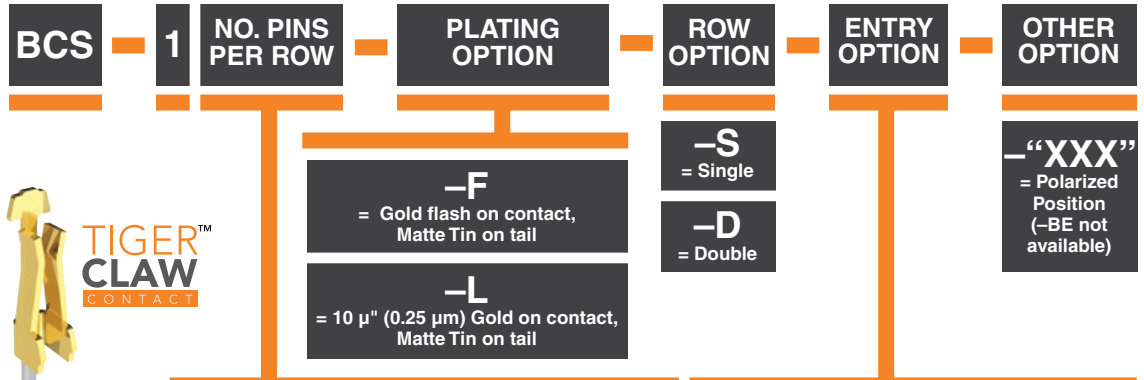

01 thru 50

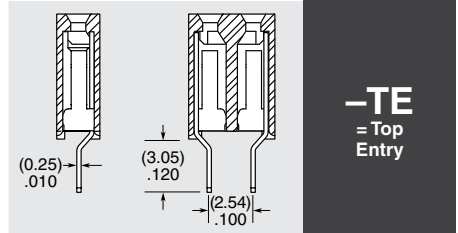
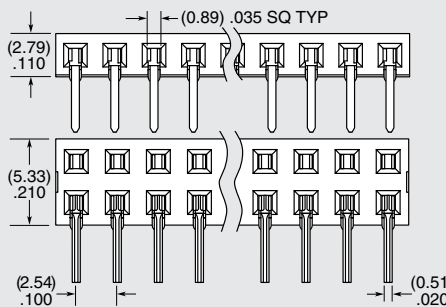
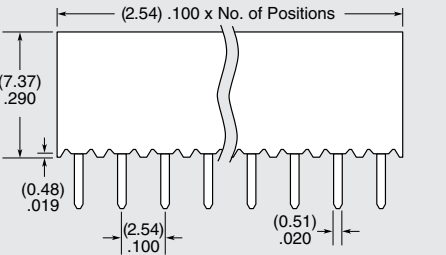
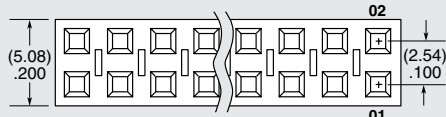
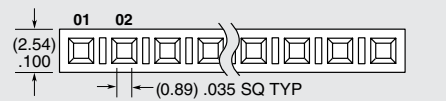

-TE
 = Top Entry

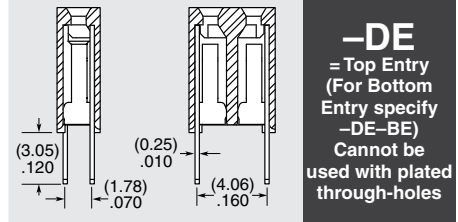

-DE
 = Top Entry (For Bottom Entry specify -DE-BE) Cannot be used with plated through-holes

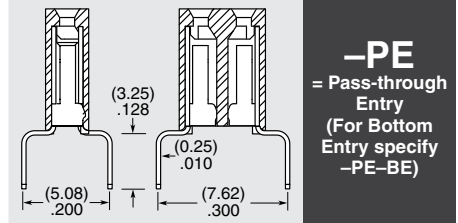

-PE
 = Pass-through Entry (For Bottom Entry specify -PE-BE)

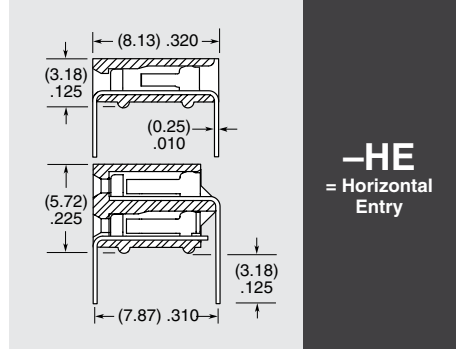

-HE
 = Horizontal Entry

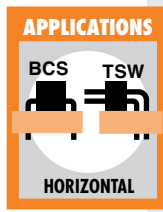

Note:
 Some lengths, styles and options are non-standard, non-returnable.

Due to technical progress, all designs, specifications and components are subject to change without notice.

WWW.SAMTEC.COM

All parts within this catalog are built to Samtec's specifications. Customer specific requirements must be approved by Samtec and identified in a Samtec customer-specific drawing to apply.

X-ON Electronics

Largest Supplier of Electrical and Electronic Components

Click to view similar products for [Board to Board & Mezzanine Connectors](#) category:

Click to view products by [Samtec](#) manufacturer:

Other Similar products are found below :

[10135583-642402LF](#) [89885-310LF](#) [589158040000018](#) [6-1393048-0](#) [68683-613](#) [MDF7-12DP-2.54DSA](#) [MDF7-18P-2.54DSA\(01\)](#) [MDF7-20DP-2.54DSA](#) [MDF7-26D-2.54DSA\(55\)](#) [MDF7-3P-2.54DSA\(01\)](#) [MDF7B-3P-2.54DSA\(55\)](#) [MDF7C-11P-2.54DSA\(55\)](#) [MDF7C-18P-2.54DSA\(55\)](#) [MDF7C-5P-2.54DSA\(01\)](#) [MDF7P-5P-2.54DSA\(55\)](#) [75234-0516](#) [FCN-230C068-11](#) [FCN-268F012-G/BD](#) [FCN-268F036-G/BD](#) [FCN-268M012-G/0D](#) [FCN-268M024-G/1D](#) [FCN-360C008-C](#) [FCN-360C040-C](#) [FCN-723J004/1](#) [MIS-048-01-F-D-DP-K](#) [832-10-034-10-001000](#) [93696-325LF](#) [11828-1FA](#) [AXK630345P](#) [18097-0013](#) [ICA-328STT](#) [2007042-2](#) [304400-2](#) [FCN-214Q030-G/0](#) [FCN-215Q040-G/0](#) [FCN-230C068-ESA](#) [FCN-234P048-G/0](#) [FCN-235D050-G/C](#) [FCN-360A3](#) [FCN-360C040-B](#) [210-93-314-41-105000](#) [2-22603-0](#) [379-064-521-202](#) [MDF7-12P-2.54DSA\(01\)](#) [MDF7-16P-2.54DS\(56\)](#) [MDF7-40DP-2.54DSA\(55\)](#) [MDF7-8P-2.54DSA\(55\)](#) [MDF7B-16P-2.54DSA\(55\)](#) [AXG720047](#) [5031084030](#)