

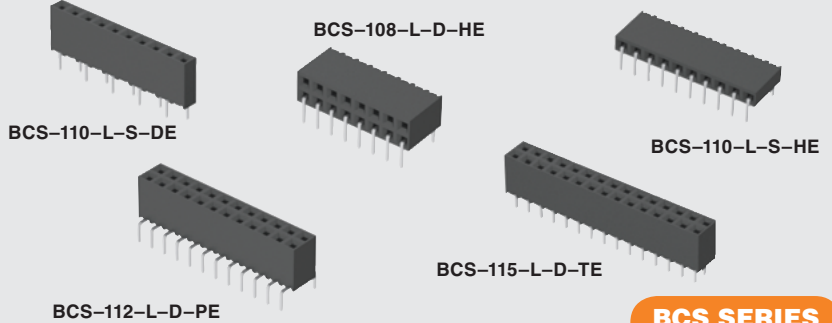

(2,54 mm) .100"



BCS SERIES

TIGER CLAW™ PASS-THROUGH SOCKET

Mates with:
 TSW, MTSW, HTSW,
 HMTSW, TSS, ZSS,
 DW, EW, ZW, HW, TSM,
 MTLW, PHT

SPECIFICATIONS

For complete specifications see www.samtec.com?BCS

Insulator Material: Black Liquid Crystal Polymer

Contact Material: Phosphor Bronze

Plating: Au or Sn over

50µ" (1,27 µm) Ni

Current Rating (BCS/TSW): 4.6 A per pin

(1 pin powered per row)

Voltage Rating: 475 VAC (-TE/-DE/-PE mated with TSM)

450 VAC (-HE mated with TSW)

Operating Temp Range: -55°C to +125°C

Contact Resistance: 10 mΩ

Insertion Depth: (4,34 mm) .171" to (7,24 mm) .285" from top, (5,64 mm) .222" plus board thickness minimum from bottom. -HE is (4,34 mm) .171" to (6,35 mm) .250"

Insertion Force: (Single contact only) 5 oz (1,39 N) avg. (.025" (0,64 mm) SQ pin)

Withdrawal Force: (Single contact only) 3 oz (0,83 N) avg. (.025" (0,64 mm) SQ pin)

RoHS Compliant: Yes

Lead-Free Solderable: Yes

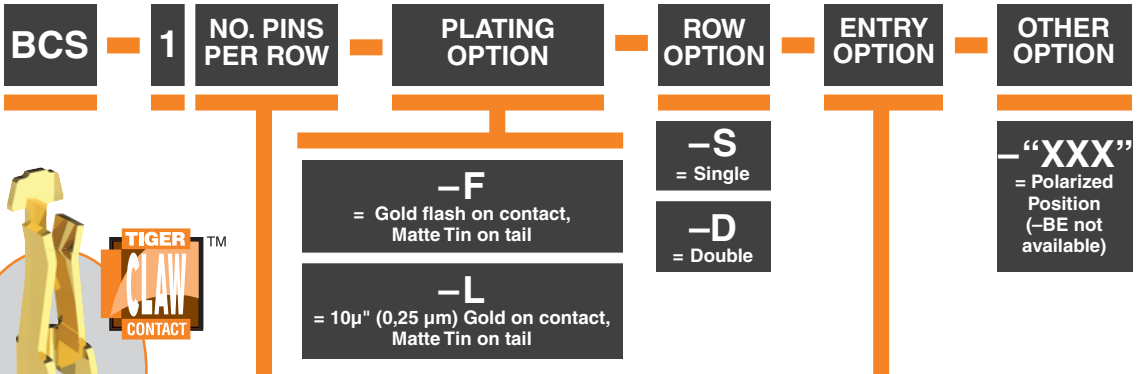

01 thru 50

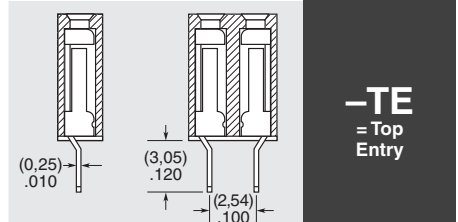
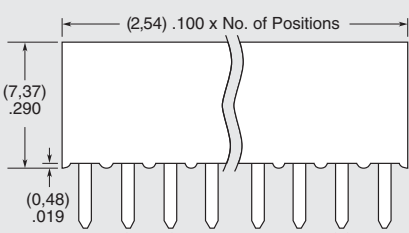
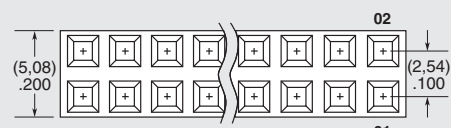

-TE
= Top Entry

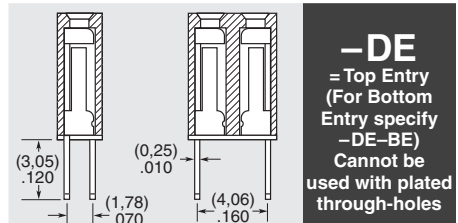

-DE
= Top Entry (For Bottom Entry specify -DE-BE) Cannot be used with plated through-holes

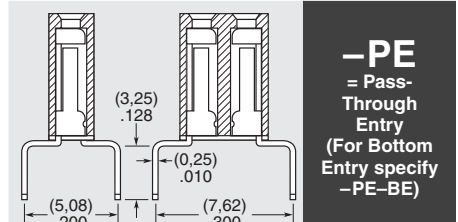

-PE
= Pass-Through Entry (For Bottom Entry specify -PE-BE)

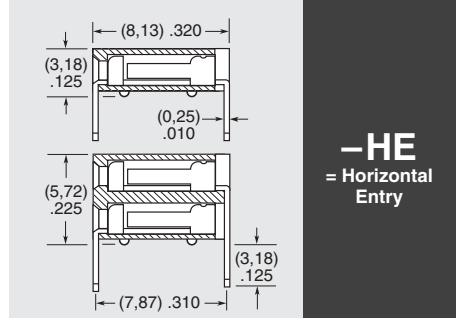
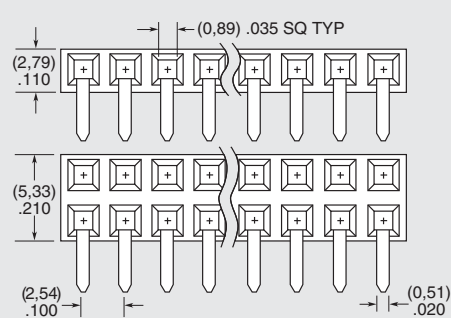

-HE
= Horizontal Entry

RECOGNITIONS

For complete scope of recognitions see www.samtec.com/quality



ALSO AVAILABLE (MOQ Required)

- Other platings
- Contact Samtec.

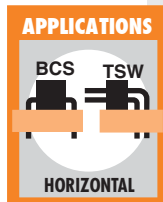

Note: Some lengths, styles and options are non-standard, non-returnable.

X-ON Electronics

Largest Supplier of Electrical and Electronic Components

Click to view similar products for [FFC & FPC Connectors](#) category:

Click to view products by [Samtec](#) manufacturer:

Other Similar products are found below :

[HFW11R-1STE1H1LF](#) [FH29B-100S-0.2SHW\(99\)](#) [FA5S008HP1](#) [FH29B-120S-0.2SHW\(99\)](#) [FH29B-80S-0.2SHW\(99\)](#) [FHS-16](#) [FPH-2022G](#)
[52610-1075](#) [52610-1275](#) [52610-1934](#) [XF3M\(1\)-1415-1B-R100](#) [501864-3091-TR225](#) [0525594033](#) [086210010340800](#) [086222026001800](#)
[52271-2869-CUT-TAPE](#) [62674-201121DLF](#) [62684-36210E9ALF](#) [52610-1675](#) [52746-1671-TR250](#) [10051922-2810EHLF](#) [6-520415-9](#)
[BD021-09A-A1-0350-0200-0550-LD](#) [SFV6R-1STE9HLF](#) [XF3M-2915-1B-R100](#) [1658549-1](#) [62674-221121ALF](#) [46214008010800](#)
[046298003000883](#) [151660622](#) [842-816-2630-035](#) [AYF530665TA](#) [AYF351525](#) [046296011930846+](#) [AYF352325A](#) [046254020000800+](#)
[FH19C-13S-0.5SH\(99\)](#) [FH39J-51S-0.3SHW\(99\)](#) [AYF355125A](#) [AYF530365TA](#) [FH29B-44S-0.2SHW\(99\)](#) [SFW5R-2STAE9LF](#) [AYF351125A](#)
[AYF350725A](#) [62684-502100AHLF](#) [FH39-61S-0.3SHW\(99\)](#) [AYF414035A](#) [10064555-172520HLF](#) [AYF212335A](#) [504754-2500](#)