

POSITION	"A"	"B"	"C"	"D"	"H"
-005	10.00 [394]	8.20 [323]	3.200 [1260]	6.80 [268]	3.25 [128]
-010	14.00 [551]	12.20 [480]	7.200 [2835]	10.80 [425]	5.25 [207]
-011	14.80 [583]	13.00 [512]	8.000 [3150]	11.60 [457]	5.65 [222]
-013	16.40 [646]	14.60 [575]	9.600 [3780]	13.20 [520]	6.45 [254]
-020	22.00 [866]	20.20 [795]	15.200 [5984]	18.80 [740]	9.25 [364]
-025	26.00 [1.024]	24.20 [953]	19.200 [7559]	22.80 [898]	11.25 [443]
-030	30.00 [1.181]	28.20 [1.110]	23.200 [9134]	26.80 [1.055]	13.25 [522]
-040	38.00 [1.496]	36.20 [1.425]	31.200 [1.2283]	34.80 [1.370]	17.25 [679]
-049	45.20 [1.780]	43.40 [1.709]	38.400 [1.5118]	42.00 [1.654]	20.85 [821]
-050	46.00 [1.811]	44.20 [1.740]	39.20 [1.543]	42.80 [1.685]	21.25 [837]
-060	54.00 [2.126]	52.20 [2.055]	47.20 [1.858]	50.80 [2.000]	25.25 [994]
-070	62.00 [2.441]	60.20 [2.370]	55.20 [2.173]	58.80 [2.315]	29.25 [1.152]
-075	66.00 [2.598]	64.20 [2.528]	59.20 [2.331]	62.80 [2.472]	31.25 [1.230]
*-100	86.00 [3.386]	84.20 [3.315]	79.20 [3.118]	82.80 [3.260]	41.25 [1.624]

fl '1 BC HHC @98 Ł

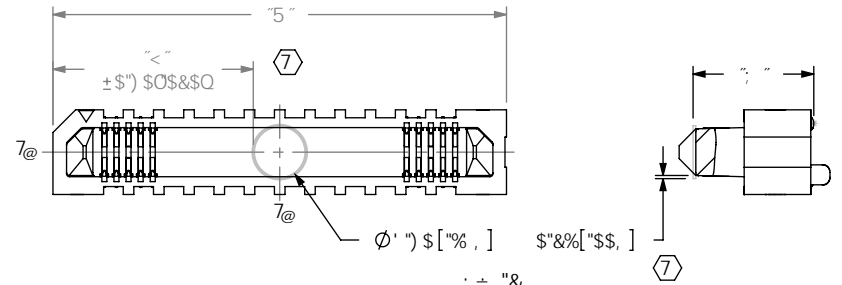

±\$) \$O\$&\$Q
 7@
 φ") \$["% .] \$"&\$["\$, \$]
 : ≠ "&
 !? 'C DHC B
 fl G9?!) \$!) \$! Ł
 f9FA , !\$ \$!LL"LL!8J!?!? G<C K B Ł
 f9C A 97 9B H9F : 95H F9GF9A C J 98 : C F '7 @5F #M Ł

HEIGHT	"E"	"F"	"G"
-02.0	1.605 [0.632]	5.965 [2.348]	5.04 [1.98]
-05.0	4.605 [1.813]	8.905 [3.506]	7.98 [3.14]
-09.0	8.605 [3.411]	12.905 [5.081]	11.98 [4.72]

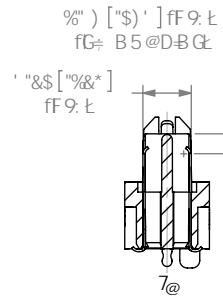

G97 H€ B "B" "B"

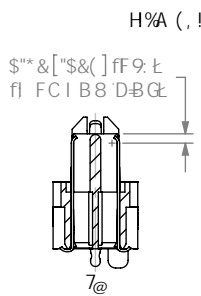

G97 H€ B "D" "D"

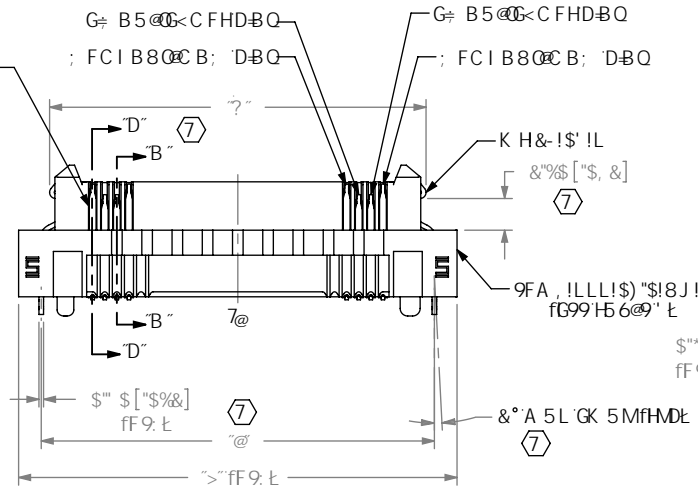

±\$) \$O\$&\$Q
 7@
 : ≠ "'
 !@/ !8GC DHC BG
 f5J 5 @6@ C B !S) "\$ @95 8GM @9 C B @M
 f9FA , !S&!) \$) "\$!L18J!8J!?!? G<C K B Ł
 f95A 95G : ±\$) \$O\$&\$Q
 f9C A 97 9B H9F : 95H F9GF9A C J 98 : C F '7 @5F #M Ł

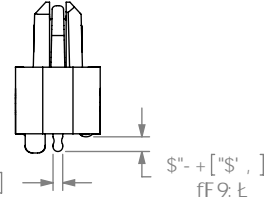

POSITION	"J"	"K"	"L"	"M"
-005	13.00 [512]	8.90 [350]	10.00 [394]	4.75 [187]
-010	17.00 [669]	12.90 [508]	14.00 [551]	6.75 [266]
-011	17.80 [701]	13.70 [539]	14.80 [583]	7.15 [281]
-013	19.40 [764]	15.30 [602]	16.40 [646]	7.95 [313]
-020	25.00 [984]	20.90 [823]	22.00 [866]	10.75 [423]
-025	29.00 [1.142]	24.90 [980]	26.00 [1.024]	12.75 [502]
-030	33.00 [1.299]	28.90 [1.138]	30.00 [1.181]	14.75 [581]
-040	41.00 [1.614]	36.90 [1.453]	38.00 [1.496]	18.75 [738]
-049	48.20 [1.898]	44.10 [1.736]	45.20 [1.780]	22.35 [880]
-050	49.00 [1.929]	44.90 [1.768]	46.00 [1.811]	22.75 [896]
-060	57.00 [2.244]	52.90 [2.083]	54.00 [2.126]	26.75 [1.053]
-070	65.00 [2.559]	60.90 [2.398]	62.00 [2.441]	30.75 [1.211]
-075	69.00 [2.717]	64.90 [2.555]	66.00 [2.598]	32.75 [1.289]
*-100	89.00 [3.504]	84.90 [3.343]	86.00 [3.386]	42.75 [1.683]

fl '1 BC HHC C @98 Ł

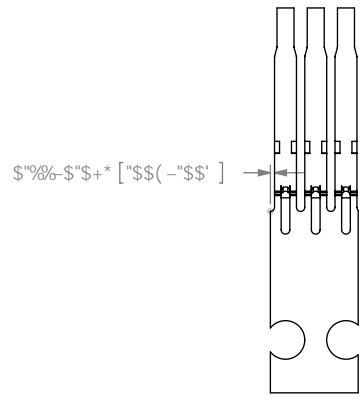

'SA 5L GK 5M



H%A ' +LL"LL!B' DFC 7 9GGJ -9K

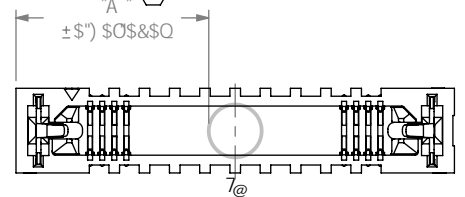

±\$) \$O\$&\$Q
 7@
 : ≠ "'
 !? 'C DHC BG
 f9FA , !S&!) \$) "\$!L18J!?!? G<C K B Ł
 f95A 95G : ±\$) \$O\$&\$Q
 f9C A 97 9B H9F : 95H F9GF9A C J 98 : C F '7 @5F #M Ł

:.P8K : PA 67 PA ?H P9FA , ILLILL"LLI8J!LLIA ?HG88F K

DFC.DF.95.FMBC.H9
 H: €8C 71A 98H7 C B15 BG B: CFA 5HC B
 7 C B : @98H5 95B8 DFC DF 94F HMC
 GSA H97 2 87 588 G: 588H69 F9DFC 81 7 98
 C F H F58G 9F98 HC C H: 9F 8C 71A 98H6 C F
 8 67 @C 98H HC C H: 9F G C F I 98 : C F 58M
 DI DFC @9 C H: 9F H: 5B H: 5HK <? < H K 5G
 C 615 B 98 K H: C I H H: 9 9 L D F 9098 K F #98
 7 C B 98HC : GSA H97 2 87 *

8C 'BCHG7 5@ 8F5K B:

G: 99H7 5@ 9 & %



)&\$ D5F? 95GH6@ 8ZB9K 5@5BM-B (+)% \$
 D<C B9 ; %&L - ((! * + % & ') : ; < , - . /) \$ +
 YIA UJ ; b z 4 GSA H97 Wc a Wc XY .)) &&

89G7 F DHC B.
 \$? , A A '98 ; 9F5H9'H9FA #B5@5CG9A 6@M

8K : "'BC"
 9FA , !LLL!LL"LL!8J!LLL

6M ?BCK @9B - #&+##\$) G<99H & C : '

X-ON Electronics

Largest Supplier of Electrical and Electronic Components

Click to view similar products for [Samtec manufacturer](#):

Other Similar products are found below :

[YTW-20-07-H-6-520-110](#) [ZSTMM-125-03-G-D-445](#) [TW-10-08-H-D-616-107](#) [FTS-113-01-H-D](#) [MTMM-136-06-H-D-220](#) [MTMM-108-05-H-D-220](#) [TW-20-03-H-6-175-225](#) [TW-30-08-H-D-616-107](#) [TW-15-08-H-D-600-080](#) [MTMM-103-05-H-D-220](#) [MTMM-120-14-H-D-180](#) [SSM-105-H-DV-A-P-TR](#) [MTMM-120-06-H-D-180](#) [ERCD-060-19.00-TEU-TBL-1-3](#) [SSQ-108-01-SM-S](#) [SSQ-105-01-SM-S](#) [ACD-185680-02](#) [ESQT-112-02-F-D-375](#) [ESQT-135-03-F-D-380](#) [FTSH-111-01-L-DV](#) [MSAS-179-ZUGG-18](#) [MTMM-103-05-H-D-300](#) [MTMM-142-05-H-D-126](#) [MTSW-103-07-F-S-240](#) [MTSW-108-24-H-D-285](#) [ERF8-020-05.0-S-DV-K-TR](#) [IDMD-10-T-12.00-A-G-R](#) [IPL1-110-02-L-D-K](#) [IPL1-112-01-L-D-K](#) [SFML-115-01-S-D](#) [SFML-125-01-S-D](#) [SFML-150-T1-S-D](#) [SFSDT-15-28-H-04.50-DR-NDS](#) [LSHM-120-02.5-L-DV-A-N-K-TR](#) [SMS-125-02-S-D](#) [ESQ-110-14-G-D](#) [ESQ-120-13-G-D](#) [ESQ-120-37-G-T](#) [ESQT-125-03-F-D-310](#) [SO-0515-01-01-02](#) [SSQ-111-01-G-S](#) [CES-150-01-T-D](#) [QFS-052-01-SL-D-RA](#) [QTE-040-04-L-D-A](#) [QTH-020-04-F-D-DP-A-K-TR](#) [QTH-060-01-F-D-A](#) [QTH-090-04-L-D-A](#) [QTH-120-02-L-D-A-K](#) [TCSD-08-D-02.50-01](#) [TCSD-10-S-05.00-01-F-N](#)