

DO NOT
SCALE FROM
THIS PRINT

Pb THIS PRODUCT MANUFACTURED
WITH LEAD-FREE PROCESSING

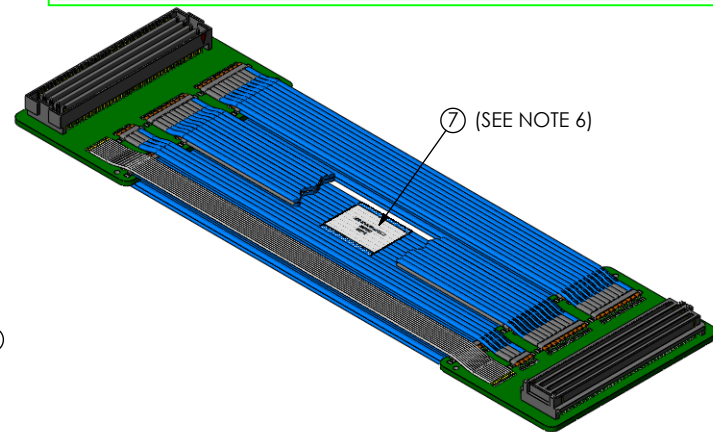

**ALL CABLE TERMINATIONS
TO BE POTTED WITH UV EPOXY
(SEE SHT 2)**

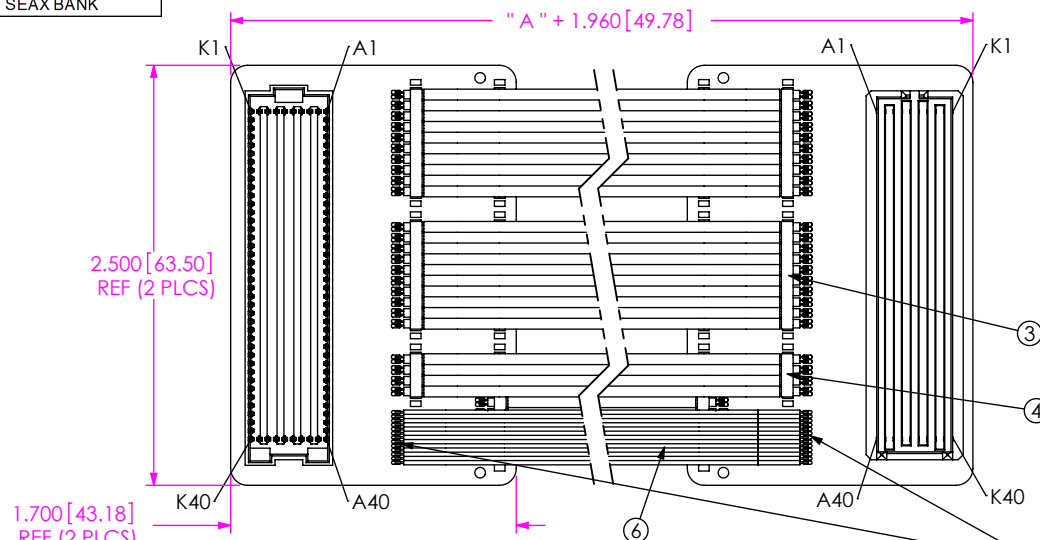
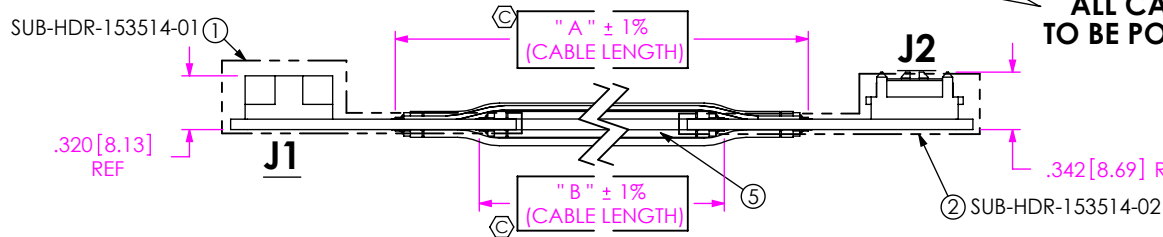

*** NON STANDARD LENGTH IS NOT STOCKED**

PART #	"A"	"B"
HDR-153514-01	9.84 [250.0]	8.84 [224.6]
HDR-153514-02	19.69 [500.0]	18.69 [474.6]
HDR-153514-03*	36.00 [914.4]	35.00 [889.0]
HDR-153514-04*	39.37 [1,000.0]	38.37 [974.6]

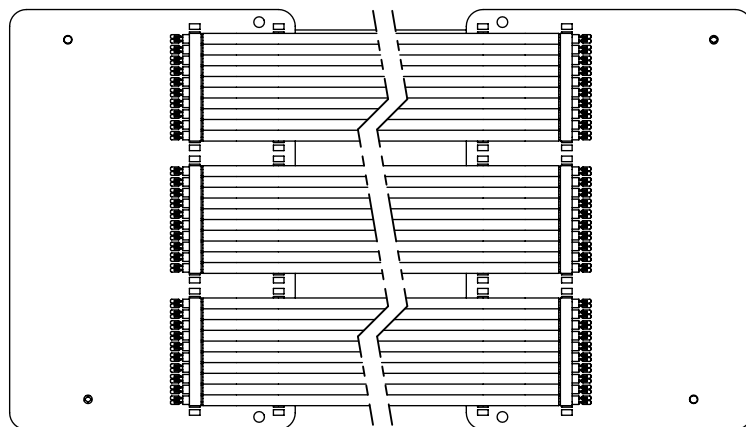

C1-D-ET
C2-D-ET

- NOTES:
- CABLE CONFIGURATION IS NOT STANDARD.
 - Ⓢ REPRESENTS A CRITICAL DIMENSION.
 - PARTS TO BE PROCESSED PER SAMTEC BOUNDARY DOCUMENT GUIDELINES.
 - ALL ASSEMBLIES TO BE 100% ELECTRICALLY TESTED.
 - ALL ASSEMBLIES TO BE 100% HI-POT TESTED AT 300V.
 - ITEM 7 TO BE CENTERED ON ITEM 5 AS SHOWN. ITEM 7 TO CONTAIN:
LINE 1 - PART NUMBER "HDR-XXXXX-XX"
LINE 2 - SHOP ORDER NUMBER "XXXXXX"
LINE 3 - DATE CODE "XXXXX".
 - FOR PROCESSING INFORMATION ON SUB ASSEMBLY, REFERENCE SUB-HDR-153514-XX TRAVELER.XLS.
 - FOR SUB-ASSEMBLY AND FINISHED GOOD PACKAGING REQUIREMENTS, REFERENCE PACKAGING STANDARD CO-HD-WI-3033-M.
 - PANEL PCB-102444-HDR-XX YIELDS (02) PCB-102444-HDR-01 AND (02) PCB-102444-HDR-02 BOARDS.

ITEM NO.	PART NUMBER	DESCRIPTION	QUANTITY	MATERIAL
1	SUB-HDR-153514-01	SUB ASSEMBLY	1	SUB ASSEMBLY
2	SUB-HDR-153514-02	SUB ASSEMBLY	1	SUB ASSEMBLY
3	SUB-TTF-32100-10-01-XX.XX("A")	TMNAX CABLE	5	SUB ASSEMBLY
4	SUB-TTF-32100-04-01-XX.XX("A")	TMNAX CABLE	1	SUB ASSEMBLY
5	SUB-TTF-32100-10-01-XX.XX("B")	TMNAX CABLE	6	SUB ASSEMBLY
6	SUB-SPL-30-13-02-XX.XX ("A")	NON SHIELDED CABLE	1	SUB ASSEMBLY
7	HDRL-11	LABEL	1	SELF LAMINATING VINYL

TOLERANCES DO NOT APPLY TO REFERENCE DIMENSIONS, UNLESS OTHERWISE SPECIFIED, DIMENSIONS ARE IN INCHES.
TOLERANCES ARE:
DECIMALS .XX: ±.01 [.3]
.XXX: ±.005 [.13]
.XXXX: ±.0020 [.051]
ANGLES 2°

PROPRIETARY NOTE
THIS DOCUMENT CONTAINS INFORMATION CONFIDENTIAL AND PROPRIETARY TO SAMTEC, INC. AND SHALL NOT BE REPRODUCED OR TRANSFERRED TO OTHER DOCUMENTS OR DISCLOSED TO OTHERS OR USED FOR ANY PURPOSE OTHER THAN THAT WHICH IT WAS OBTAINED WITHOUT THE EXPRESSED WRITTEN CONSENT OF SAMTEC, INC.



520 PARK EAST BLVD, NEW ALBANY, IN 47150
PHONE: 812-944-6733 FAX: 812-948-5047
e-Mail: info@SAMTEC.com code 53322

DO NOT SCALE DRAWING SHEET SCALE: 7:8

DESCRIPTION: CUSTOM HDR CABLE ASSEMBLY

DWG. NO. HDR-153514-XX

BY: ANDREW C 02/22/2010 SHEET 1 OF 3

Pb THIS PRODUCT MANUFACTURED WITH LEAD-FREE PROCESSING

Pb THIS PRODUCT MANUFACTURED WITH LEAD-FREE PROCESSING

**SUB SETUP OPTION:
HDR-SUB-02**

**SUB SETUP OPTION:
HDR-SUB-02**

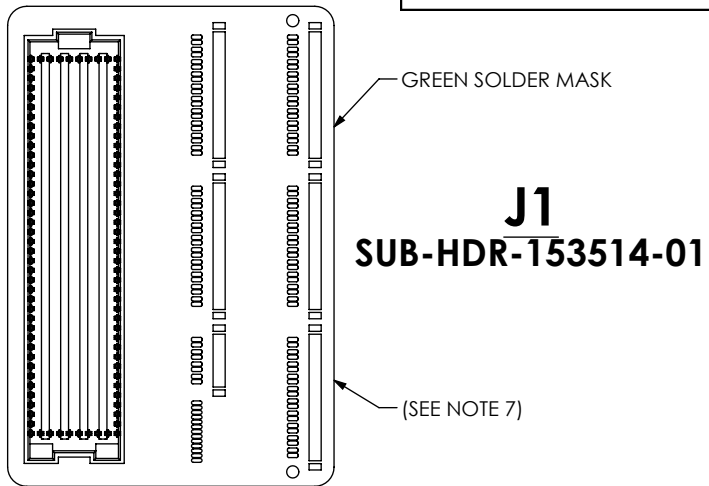

**J1
SUB-HDR-153514-01**

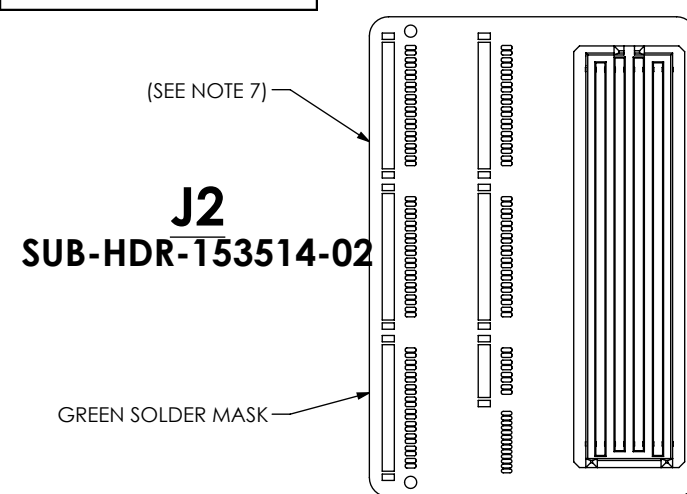

**J2
SUB-HDR-153514-02**

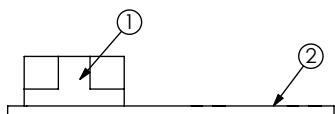

PARTS TO BE PACKAGED IN PAW PACK

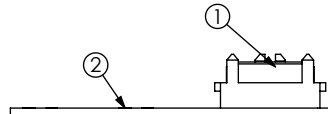

PARTS TO BE PACKAGED IN PAW PACK

SUB-HDR-153514-01 BOM

ITEM NO.	PART NUMBER	QUANTITY	MATERIAL
1	ASP-134486-01	1	SOCKET
2	PCB-102444-HDR-01	1	PCB

SUB-HDR-153514-02 BOM

ITEM NO.	PART NUMBER	QUANTITY	MATERIAL
1	ASP-134488-01	1	TERMINAL
2	PCB-102444-HDR-02	1	PCB

TYPE	NETS	POINTS
POINT TO POINT	226	452
GND	1	318
POWER - 12POV	1	4
POWER - 3P3V	1	8
POWER - 3P3VAUX	1	2
POWER - VADJ	1	8
POWER - VIO_B_M2C	1	2
POWER - VREF A M2C	1	2
POWER - VREF B M2C	1	4

**CRITICAL DIMENSION INSPECTION
INSTRUCTION TABLE**

ASSEMBLY OPERATION	IN-PROCESS INSPECTION
PREP CABLE	C3, C4
E-TEST	C1, C2

**ALL CABLE TERMINATIONS
TO BE POTTED WITH UV EPOXY**

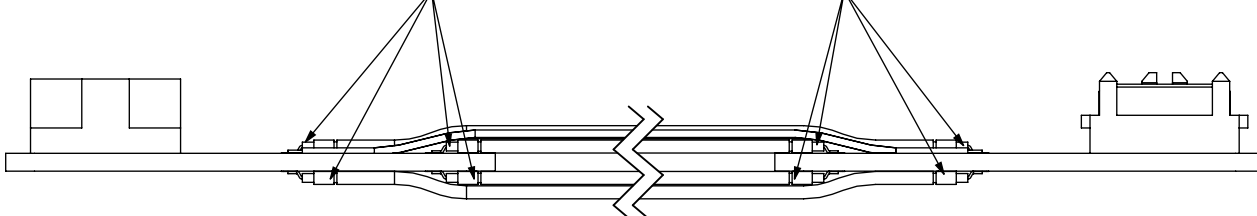

PROPRIETARY NOTE

THIS DOCUMENT CONTAINS INFORMATION CONFIDENTIAL AND PROPRIETARY TO SAMTEC, INC. AND SHALL NOT BE REPRODUCED OR TRANSFERRED TO OTHER DOCUMENTS OR DISCLOSED TO OTHERS OR USED FOR ANY PURPOSE OTHER THAN THAT WHICH IT WAS OBTAINED WITHOUT THE EXPRESSED WRITTEN CONSENT OF SAMTEC, INC.

DO NOT SCALE DRAWING

SHEET SCALE: 1:1



520 PARK EAST BLVD, NEW ALBANY, IN 47150
PHONE: 812-944-6733 FAX: 812-948-5047
e-Mail info@SAMTEC.com code 55322

DESCRIPTION:
CUSTOM HDR CABLE ASSEMBLY

DWG. NO.
HDR-153514-XX

BY: ANDREW C 02/22/2010 SHEET 2 OF 3

TABLE 1
SIGNAL MAPPING

	A	B	C	D	E	F	G	H	J	K
1	GND	RES1	GND	PG C2M	GND	PG M2C	GND	VREF A M2C	GND	VREF B M2C
2	DP1_M2C_P	GND	DP0_C2M_P	GND	HA01_P_CC	GND	CLK1_M2C_N	PRSNT_M2C_L	CLK3_M2C_N	GND
3	DP1_M2C_N	GND	DP0_C2M_N	GND	HA01_N_CC	GND	CLK1_M2C_P	GND	CLK3_M2C_P	GND
4	GND	DP9_M2C_P	GND	GBTCLK0_M2C_P	GND	HA00_P_CC	GND	CLK0_M2C_N	GND	CLK2_M2C_N
5	GND	DP9_M2C_N	GND	GBTCLK0_M2C_N	GND	HA00_N_CC	GND	CLK0_M2C_P	GND	CLK2_M2C_P
6	DP2_M2C_P	GND	DP0_M2C_P	GND	HA05_P	GND	LA00_P_CC	GND	HA03_P	GND
7	DP2_M2C_N	GND	DP0_M2C_N	GND	HA05_N	HA04_P	LA00_N_CC	LA02_P	HA03_N	HA02_P
8	GND	DP8_M2C_P	GND	LA01_P_CC	GND	HA04_N	GND	LA02_N	GND	HA02_N
9	GND	DP8_M2C_N	GND	LA01_N_CC	HA09_P	GND	LA03_P	GND	HA07_P	GND
10	DP3_M2C_P	GND	LA06_P	GND	HA09_N	HA08_P	LA03_N	LA04_P	HA07_N	HA06_P
11	DP3_M2C_N	GND	LA06_N	LA05_P	GND	HA08_N	GND	LA04_N	GND	HA06_N
12	GND	DP7_M2C_P	GND	LA05_N	HA13_P	GND	LA08_P	GND	HA11_P	GND
13	GND	DP7_M2C_N	GND	GND	HA13_N	HA12_P	LA08_N	LA07_P	HA11_N	HA10_P
14	DP4_M2C_P	GND	LA10_P	LA09_P	GND	HA12_N	GND	LA07_N	GND	HA10_N
15	DP4_M2C_N	GND	LA10_N	LA09_N	HA16_P	GND	LA12_P	GND	HA14_P	GND
16	GND	DP6_M2C_P	GND	GND	HA16_N	HA15_P	LA12_N	LA11_P	HA14_N	HA17_P_CC
17	GND	DP6_M2C_N	GND	LA13_P	GND	HA15_N	GND	LA11_N	GND	HA17_N_CC
18	DP5_M2C_P	GND	LA14_P	LA13_N	HA20_P	GND	LA16_P	GND	HA18_P	GND
19	DP5_M2C_N	GND	LA14_N	GND	HA20_N	HA19_P	LA16_N	LA15_P	HA18_N	HA21_P
20	GND	GBTCLK1_M2C_P	GND	LA17_P_CC	GND	HA19_N	GND	LA15_N	GND	HA21_N
21	GND	GBTCLK1_M2C_N	GND	LA17_N_CC	HB03_P	GND	LA20_P	GND	HA22_P	GND
22	DP1_C2M_P	GND	LA18_P_CC	GND	HB03_N	HB02_P	LA20_N	LA19P	HA22_N	HA23_P
23	DP1_C2M_N	GND	LA18_N_CC	LA23_P	GND	HB02_N	GND	LA19_N	GND	HA23_N
24	GND	DP9_C2M_P	GND	LA23_N	HB05_P	GND	LA22_P	GND	HB01_P	GND
25	GND	DP9_C2M_N	GND	GND	HB05_N	HB04_P	LA22_N	LA21_P	HB01_N	HB00_P_CC
26	DP2_C2M_P	GND	LA27_P	LA26_P	GND	HB04_N	GND	LA21_N	GND	HB00_N_CC
27	DP2_C2M_N	GND	LA27_N	LA26_N	HB09_P	GND	LA25_P	GND	HB07_P	GND
28	GND	DP8_C2M_P	GND	GND	HB09_N	HB08_P	LA25_N	LA24_P	HB07_N	HB06_P_CC
29	GND	DP8_C2M_N	GND	TCK	GND	HB08_N	GND	LA24_N	GND	HB06_N_CC
30	DP3_C2M_P	GND	SCL	TDI	HB13_P	GND	LA29_P	GND	HB11_P	GND
31	DP3_C2M_N	GND	SDA	TDO	HB13_N	HB12_P	LA29_N	LA28_P	HB11_N	HB10_P
32	GND	DP7_C2M_P	GND	3P3VAUX	GND	HB12_N	GND	LA28_N	GND	HB10_N
33	GND	DP7_C2M_N	GND	TMS	HB19_P	GND	LA31_P	GND	HB15_P	GND
34	DP4_C2M_P	GND	GA0	TRST_L	HB19_N	HB16_P	LA31_N	LA30_P	HB15_N	HB14_P
35	DP4_C2M_N	GND	12POV	GA1	GND	HB16_N	GND	LA30_N	GND	HB14_N
36	GND	DP6_C2M_P	GND	3P3V	HB21_P	GND	LA33_P	GND	HB18_P	GND
37	GND	DP6_C2M_N	12POV	GND	HB21_N	HB20_P	LA33_N	LA32_P	HB18_N	HB17_P_CC
38	DP5_C2M_P	GND	GND	3P3V	GND	HB20_N	GND	LA32_N	GND	HB17_N_CC
39	DP5_C2M_N	GND	3P3V	GND	VADJ	GND	VADJ	GND	VIO_B_M2C	GND
40	GND	RES0	GND	3P3V	GND	VADJ	GND	VADJ	GND	VIO_B_M2C

PROPRIETARY NOTE
THIS DOCUMENT CONTAINS INFORMATION CONFIDENTIAL AND PROPRIETARY TO SAMTEC, INC. AND SHALL NOT BE REPRODUCED OR TRANSFERRED TO OTHER DOCUMENTS OR DISCLOSED TO OTHERS OR USED FOR ANY PURPOSE OTHER THAN THAT WHICH IT WAS OBTAINED WITHOUT THE EXPRESSED WRITTEN CONSENT OF SAMTEC, INC.



520 PARK EAST BLVD, NEW ALBANY, IN 47150
PHONE: 812-944-6733 FAX: 812-948-5047
e-Mail: info@SAMTEC.com code 53322

DO NOT SCALE DRAWING

DESCRIPTION:
CUSTOM HDR CABLE ASSEMBLY

DWG. NO.
HDR-153514-XX

SHEET SCALE: 1:1

BY: ANDREW C 02/22/2010 SHEET 3 OF 3

X-ON Electronics

Largest Supplier of Electrical and Electronic Components

Click to view similar products for [Ribbon Cables / IDC Cables](#) category:

Click to view products by [Samtec](#) manufacturer:

Other Similar products are found below :

[FSK-12A](#) [AWG28-10G](#) [EHJ3C](#) [EHJ4C](#) [cab-LVDV-PWR-10-15](#) [FSP-25A](#) [3365/15 \(100FT\)](#) [cab-LVDV-DAT-34-15](#) [49635-C62-S2](#) [1-3636-600-5204](#) [92315-1408](#) [426171120-3](#) [3625/08 \(100M\)](#) [0044704](#) [2-1589735-3](#) [JSM015PP2DCC23N](#) [92301-0283](#) [ACL-eSSI-2](#) [92301-0718](#) [MMSDT-06-20-S-05.5-D-K-LDX](#) [IDD-04-G](#) [NM-2J2-051-PS1-JJAB](#) [1700/14SF \(100FT\)](#) [1700/26SF \(100FT\)](#) [1700/34SF \(100FT\)](#) [3801/09 \(100FT\)](#) [119-885](#) [DS1057-06A282R-30.5](#) [DS1057-12A282R-30.5](#) [DS1057-14A282R-76.5](#) [DS1057-20A282R-76.5](#) [DS1057-24A282R-76.5](#) [DS1057-26A282R-76.5](#) [DS1057-30A282R-76.5](#) [DS1057-34A282R-76.5](#) [DS1057-40A282R-76.5](#) [DS1057-60A282R-76.5](#) [DS1057-64A282R-76.5](#) [DS1058-08M28-30.5](#) [DS1058-30M28-30.5](#) [3750/10 \(100FT\)](#) [0015712](#) [0015905](#) [S30109](#) [11203](#) [11223](#) [11243](#) [11262](#) [0037147](#) [0022512](#)