

IPBT-105-H2-T-D-K

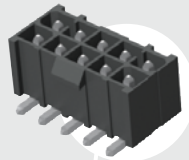

IPBT-108-H1-T-D-RA-K

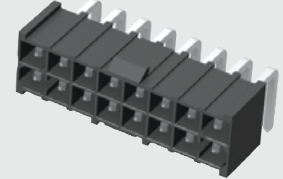

IPBT-105-H1-T-D-GP

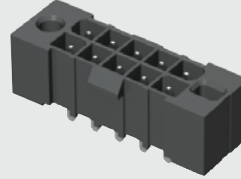

IPBT SERIES

(4.19 mm) .165"

ISOLATED TERMINAL POWER HEADER

SPECIFICATIONS

For complete specifications see www.samtec.com?IPBT

Insulator Material: Black Liquid Crystal Polymer

Contact Material: High Copper Alloy

Plating: Sn over 50 μm (1.27 μm) Ni

Operating Temp Range: -55 °C to +105 °C

Voltage Rating: 400 VAC/565 VDC

Standard Creepage: (3.66 mm) .144" (-S)

(3.63 mm) .143" (-D)

Standard Clearance: (3.05 mm) .120"

RoHS Compliant: Yes

Lead-Free Solderable: Yes

IPBT/IPBS	
PINS POWERED	CURRENT RATING (PER CONTACT)
2	10.3 A
4	8.4 A
6	7.6 A
8	7.1 A
30	6.0 A

Board Mates: IPBS

Cable Mates: PMSD, PMSS

CREEPAGE AND CLEARANCE

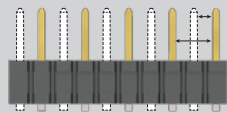

Selectively loading contacts achieves customer specific creepage and clearance requirements. Contact asp@samtec.com

Latching mechanism for mating with IPBD Series

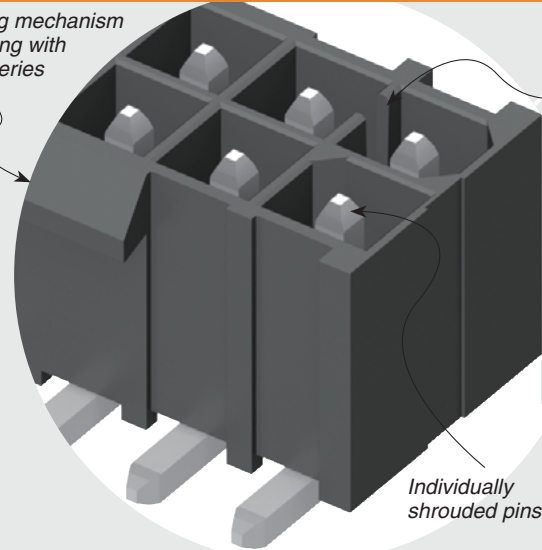

Keyed polarization

Individually shrouded pins

RUGGEDIZED BY SAMTEC

- Individually shrouded contacts
- Polarized guide post hole option

RECOGNITIONS

For complete scope of recognitions see www.samtec.com/quality



APPLICATION

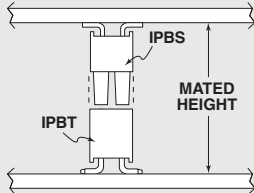

IPBT/IPBS LEAD STYLE	MATED HEIGHT*
H1-01	(15.25) .600
-H2-02	(16.84) .663

*Processing conditions will affect mated height.

ALSO AVAILABLE (MOQ Required)

- Other sizes
- Other lead styles

Note: Some lengths, styles and options are non-standard, non-returnable.



02, 03, 04, 05, 08, 10, 15
(-D only)

02, 03, 04, 05, 08, 10
(-S only)
(Standard sizes)

LEAD STYLE

- H1 = Through-hole
- H2 = Surface Mount

PLATING OPTION

- T = Matte Tin

ROW OPTION

- S = Single Row
- D = Double Row

OPTION

- RA = Right-angle (Lead Style -H1 only)
- GP = Guide Post Holes (Not available with -K)
- K = Keyed Polarization (not available with -GP option, is required callout if -GP not called out)

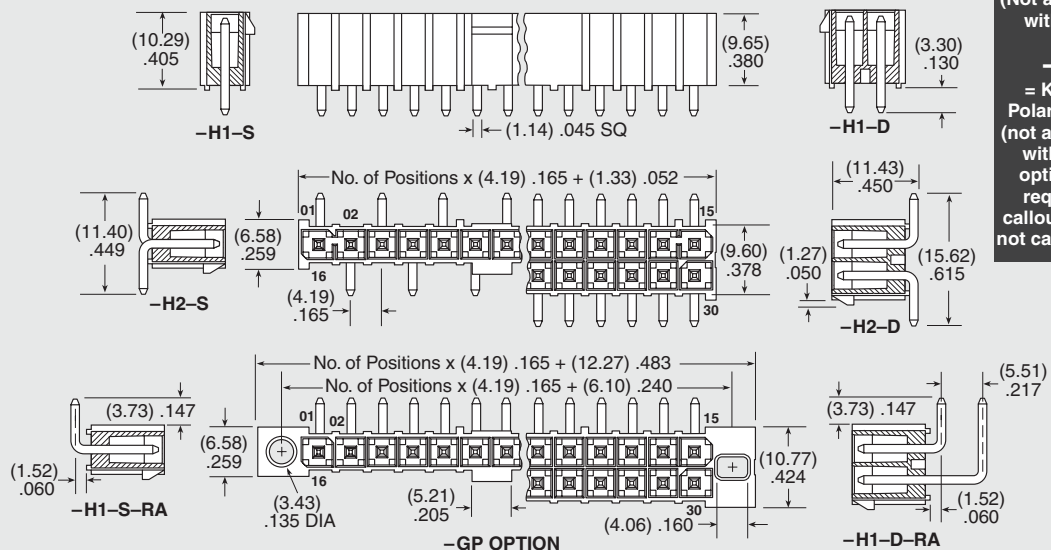

Due to technical progress, all designs, specifications and components are subject to change without notice.

X-ON Electronics

Largest Supplier of Electrical and Electronic Components

Click to view similar products for [Power to the Board](#) category:

Click to view products by [Samtec](#) manufacturer:

Other Similar products are found below :

[10131318-08512GRLF](#) [6450171-4](#) [6450552-7](#) [6600323-8](#) [6643429-1](#) [6646040-2](#) [6651939-1](#) [6766604-1](#) [120959-1](#) [1393557-2](#) [1393532-2](#)
[1393532-3](#) [1393532-4](#) [1393557-1](#) [1600812-5](#) [1-6450861-2](#) [1645595-1](#) [1743490-1](#) [1744132-7](#) [1761122-1](#) [1766169-1](#) [1766250-1](#) [18362](#)
[1892109-1](#) [1-967627-6](#) [2226808-1](#) [2-6450860-5](#) [2-6450860-6](#) [2-6450870-0](#) [93003-0502](#) [953552-1](#) [1-6450161-4](#) [1-6450850-6](#) [1645526-2](#) [1-](#)
[6600130-0](#) [1743419-1](#) [1766150-1](#) [2005243-2](#) [211110-1](#) [2-6600130-2](#) [TE34-12-16P-F0](#) [5-6450830-6](#) [5646956-4](#) [36662-0005](#) [40585-3000](#) [4-](#)
[6450830-9](#) [4-6600333-3](#) [51142-0214](#) [10134048-911LF](#) [10123159-301LF](#)