

(2.54 mm) .100"

OPP SERIES

ONE-PIECE POWER INTERFACE

SPECIFICATIONS

For complete specifications and recommended PCB layouts see www.samtec.com?OPP

Insulator Material:
Black Liquid Crystal Polymer
Contact Material:
BeCu
Plating:
Sn over 50 μ" (1.27 μm) Ni
Operating Temp Range:
-55 °C to +105 °C
Current Rating:
9.6 A per pin
(1 pin powered)
Voltage Rating:
280 VAC
RoHS Compliant:
Yes

Processing:
Lead-Free Solderable:
Yes
SMT Lead Coplanarity:
(0.15 mm) .006" max

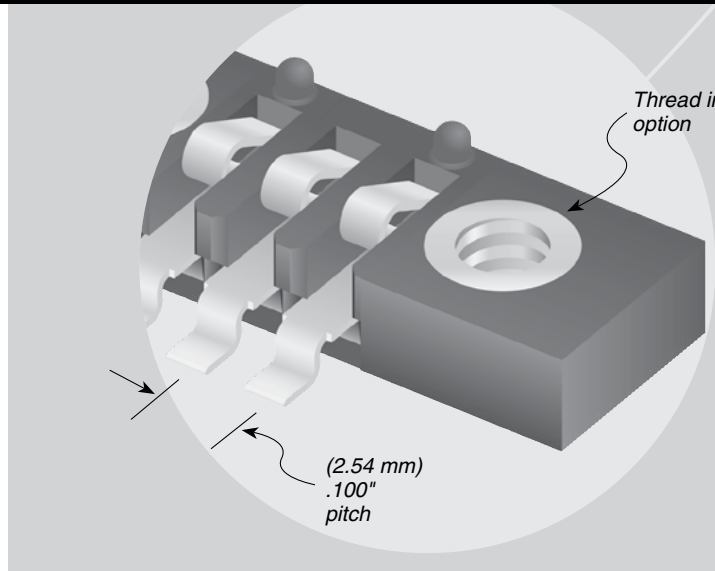

RECOGNITIONS

For complete scope of recognitions see www.samtec.com/quality



FILE NO. E111594

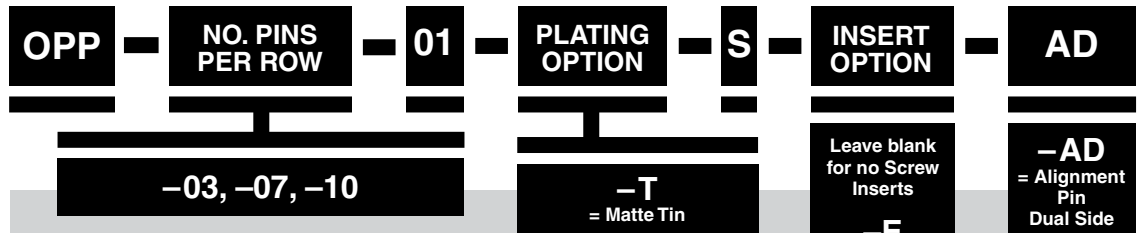

ALSO AVAILABLE (MOQ Required)

- Alternative alignment pin available
Contact Samtec.

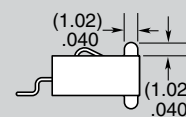
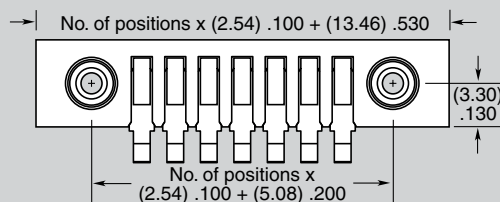
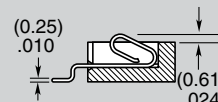
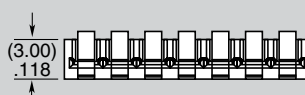
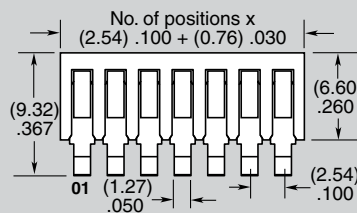

-AD OPTION

Note: Some sizes, styles and options are non-standard, non-returnable.

X-ON Electronics

Largest Supplier of Electrical and Electronic Components

Click to view similar products for [Headers & Wire Housings](#) category:

Click to view products by [Samtec](#) manufacturer:

Other Similar products are found below :

[892-18-020-10-001101](#) [58102-G61-06LF](#) [582553-1](#) [0009485154](#) [009176003701906](#) [0050291907](#) [LY20-4P-DT1-P1E-BR](#) [02.125.8002.8](#)
[609-3404](#) [61062-3](#) [61082-181009](#) [622-3653LF](#) [63453-116](#) [636-1030](#) [636-1427](#) [636-3427](#) [636-4007](#) [641938-9](#) [641991-4](#) [644827-2](#) [65817-](#)
[010LF](#) [65817-015LF](#) [65863-015LF](#) [66207-023LF](#) [67095-007LF](#) [67601157](#) [68645-018](#) [68648-049](#) [70.362.1628.0](#) [70-4210](#) [70-4226B](#) [70-](#)
[4853B](#) [707-5020](#) [707-5028](#) [71.350.2428.0](#) [71918-208LF](#) [71961-016LF](#) [733-134](#) [733-162](#) [754199-000](#) [760-3052](#) [787-8014-00](#) [79531-3000](#)
[FCN-360C032-B](#) [FCN-367T-T012/H](#) [FCN-723D010/2](#) [80.063.4001.1](#) [800-90-001-10-001000](#) [800-90-010-10-002000](#) [801-43-002-10-013000](#)