

QSFP8-PF-02

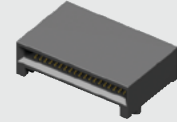

QSFP8-038-01-L-D-RA1

(0.80 mm) .0315"

QSFP8, QSFP8-PF, QSFP8-PF SERIES

QSFP CONNECTOR & CAGE

SPECIFICATIONS

For complete specifications and recommended PCB layouts see www.samtec.com?QSFP8

Insulator Material:

LCP

Contact Material:

Phosphor Bronze

Ground Plane:

Phosphor Bronze

Plating:

Au or Sn over 50 μ" (1.27 μm) Ni

Current Rating (QSFP8/Card):

1.6 A per pin

(2 pins powered)

RECOGNITIONS

For complete scope of recognitions see www.samtec.com/quality



Note:

Some lengths, styles and options are non-standard, non-returnable.

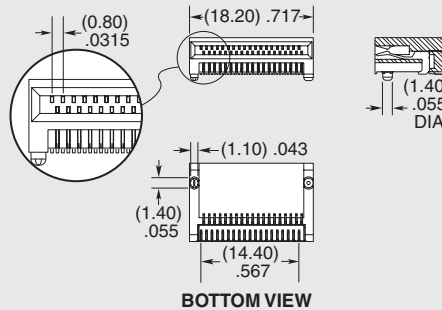
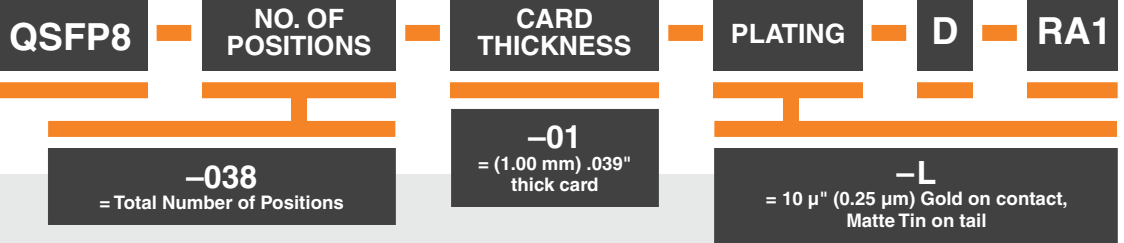

SPECIFICATIONS

For complete specifications see www.samtec.com?QSFP8-PF or www.samtec.com?QSFP8-PF

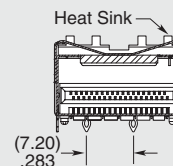
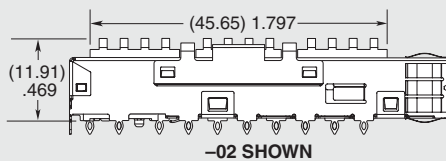
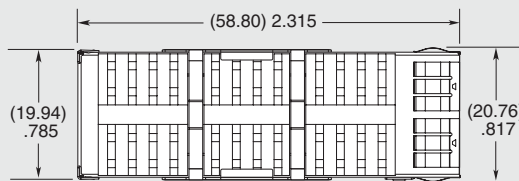
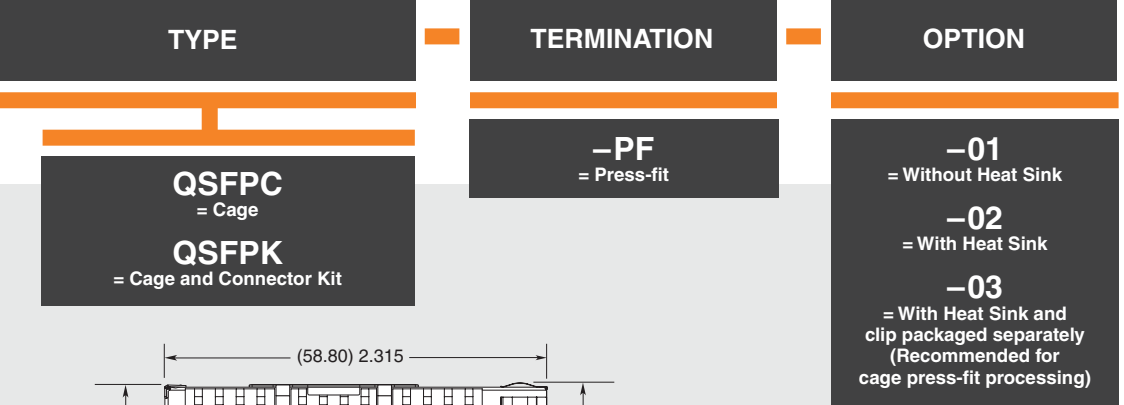

Note:

Some sizes, styles and options are non-standard, non-returnable.

Due to technical progress, all designs, specifications and components are subject to change without notice.

WWW.SAMTEC.COM

All parts within this catalog are built to Samtec's specifications.

Customer specific requirements must be approved by Samtec and identified in a Samtec customer-specific drawing to apply.

X-ON Electronics

Largest Supplier of Electrical and Electronic Components

Click to view similar products for [I/O Connectors](#) category:

Click to view products by [Samtec](#) manufacturer:

Other Similar products are found below :

[571763P](#) [72.250.1628.2](#) [72.250.2428.2](#) [74720-0505](#) [76.350.0729.0](#) [76871-1403](#) [FCN-244F080-G/1](#) [FCN-260A9920](#) [MP-5T180MUNNA-005](#)
[PCR-E36PM](#) [PCS-XE26MA+](#) [G38A71314B](#) [1571250010](#) [157-22500-3](#) [MS3471L14-19P L/C](#) [91-569786-35H](#) [172501-4002](#) [172501-6002](#)
[FCN-260C008-A/L0](#) [FCN-260C024-AL0](#) [FCN-261Z008](#) [2000314-1](#) [200331-1](#) [PCR-E36FC+](#) [PCS-E28FS+](#) [PCS-XE26SLFD+](#) [PCS-](#)
[XE26SLFDT+](#) [G730VID08BDC24](#) [HDMR-29-01-S-SM-TR](#) [U90B2054081210](#) [UE86K842720321](#) [38113800006](#) [DP3AR020WQ1R200](#)
[Z4.102.0680.0](#) [500-1040](#) [500-1052](#) [500-1054](#) [ZP-4008-66L](#) [0709821002](#) [10-565995-597N](#) [5554841-1](#) [U90B3054061110](#) [U65-E04-4020](#)
[ZPF00000000097891](#) [557-262M2-06C](#) [747360449](#) [10099439-003C-TRLF](#) [10137239-0021LF](#) [E9320-001-01](#) [10137239-0011LF](#)