

REVISION BJ

DO NOT SCALE FROM THIS PRINT

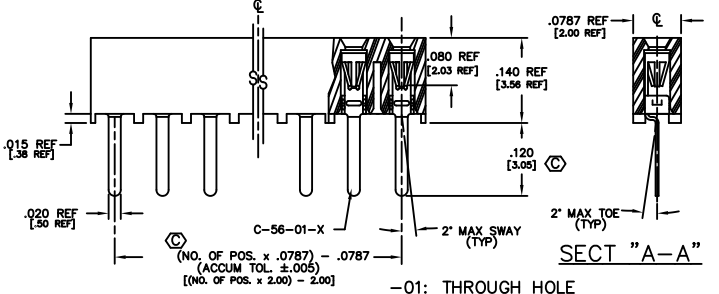

* PINS INTERLEAVED AND ORIENTED SAME DIRECTION FOR -01 ONLY

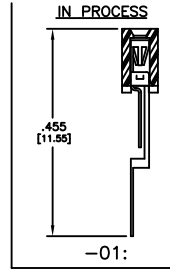
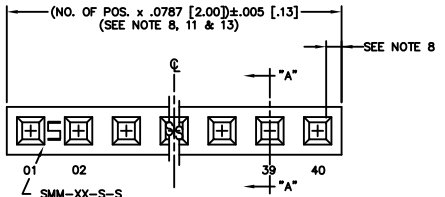
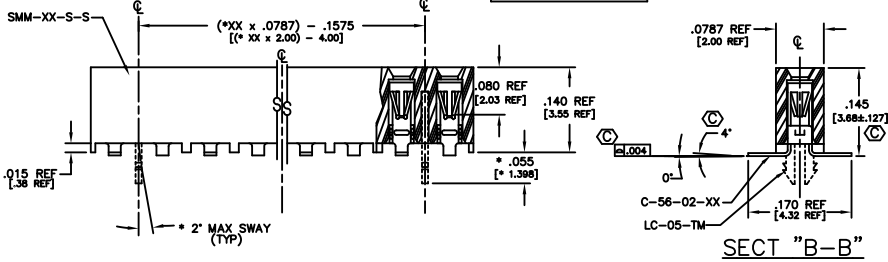
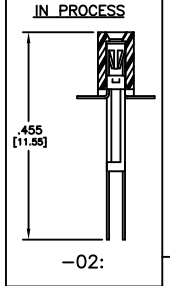
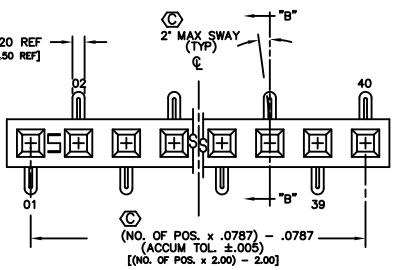

-02: SURFACE MOUNT

- NOTES:
- RETENTION FORCE IN BODY TO BE: 1 lbs. MIN
 - INSERTION FORCE TO BE: 3.0 oz. MAX.
 - WITHDRAWAL FORCE TO BE: 0.4 oz. MIN.
 - ⊙ REPRESENTS CRITICAL DIMS. FOR STATISTICAL PROCESS CONTROL.
 - [] DIMS ARE IN METRIC AND ARE NOT CONTROLLING DIMS.
 - SMM-105-01-X THRU SMM-140-01-X MUST USE PT-1-24-01-12.
 - LC OPTION FOR A 02 POSITION WILL HAVE ONLY ONE LOCKING CLIP (LC-05-T).
 - "END WALLS" AFTER CUTTING SHOULD BE .025±.005.
 - ALL OPTIONS: PACKAGE POSITIONS -04 THRU -40 IN TUBES.
 - LAYER PACKAGE POSITIONS -02 & -03 WITH NO OPTIONS.
 - 02 THRU -05 POSITION WITH -K OR -P TO BE PACKAGED IN -TR ONLY. -06 THRU -40 POSITION AVAILABLE IN TUBE OR -TR PACKAGING.
 - MAX CUT FLASH: .010 [25]
 - DUE TO THE HIGH AMOUNT OF INSERTION FORCE NEEDED, THE -LC OPTION IS NOT COMPATIBLE WITH AUTO PLACEMENT. SAMTEC RECOMMENDS MANUAL PLACEMENT FOR ALL ASSEMBLIES WITH THE -LC OPTION.
 - FOR -02 LEAD STYLE: EVEN CUTS: LOSE 2 POSITIONS PER CUT; ODD CUTS: LOSE 1 POSITION PER CUT.
 - INSULATOR MATERIAL: BLACK, LCP, UL 94 VO
 - MAXIMUM PIN HEIGHT VARIATION: .003 [08] FROM ROW TO ROW AND PIN TO PIN, MUST BE MEASURED BETWEEN ADJACENT PINS.

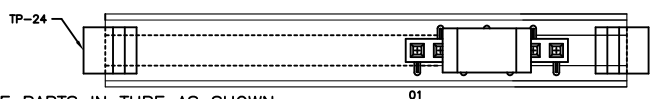
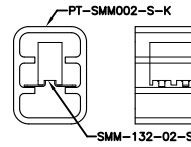

PACKAGE PARTS IN TUBE AS SHOWN (POSITION PARTS WITH POS. -01 TOWARD ARROW AS SHOWN)

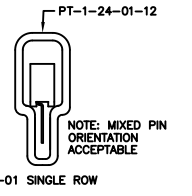

-01 SINGLE ROW

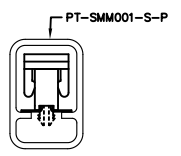

NOTE: MIXED PIN ORIENTATION ACCEPTABLE

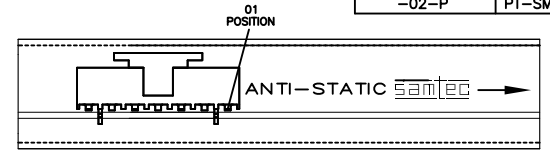

DIMENSIONS ARE IN INCHES UNLESS OTHERWISE NOTED TOLERANCES ARE: ONE PLACE DECIMALS: ± .1 THREE PLACE DECIMALS: ± .005 TWO PLACE DECIMALS: ± .01 FOUR PLACE DECIMALS: ± .0020 ANGLES: ± 1° TITLE: 2 mm SOCKET STRIP (SINGLE ROW) DWG NO.: SMM-1XX-XX-XX-S-XX-X-XX-XX SHEET 1 OF 1

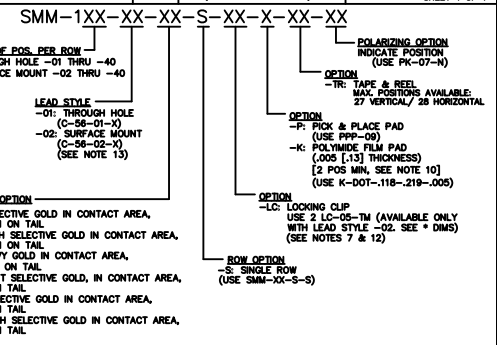

TUBE PACKAGING TABLE

LEAD STYLE	TUBE	PLUG
-01	PT-1-24-01-12	TP-12
-01-P	PT-1-24-02-29	TP-24
-02		
-02-K, -02-LC, -02-LC-K	PT-SMM002-S-K	TP-24-02
-02-P	PT-SMM001-S-P	TP-24

-K: POLYIMIDE FILM PAD

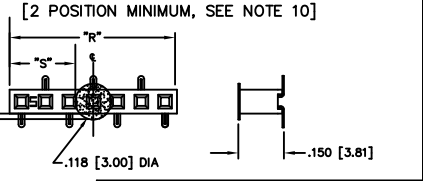

NOTE:
 "R" = USED MEASURED DIMENSION (REF)
 "S" = ("R" - .300) / 2 ± 0.20
 -P: PICK AND PLACE PAD (PLACE PPP-09 ABOUT C.L. AS SHOWN)

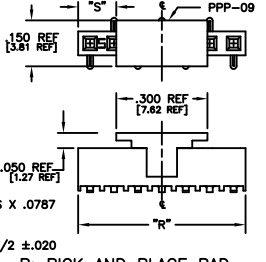

PROPRIETARY NOTE

made by: WATT KOLB 8-22-81
 DESIGNED BY: MCCARTIN
 samtec
 520 PARK EAST BLVD. NEW ALBANY, INDIANA 47150
 PHONE (812) 944-6733 P.O. BOX 1147
 CODE 55322
 SMM-1XX-XX-XX-S-XX-X-XX-XX SHEET 1 OF 1

X-ON Electronics

Largest Supplier of Electrical and Electronic Components

Click to view similar products for [Headers & Wire Housings](#) category:

Click to view products by [Samtec](#) manufacturer:

Other Similar products are found below :

[95000-104TRLF](#) [10135584-644402LF](#) [DF62W-EP2022PCA](#) [95000-106TRLF](#) [DF62W-2022SCA](#) [DF62W-EP2022PC](#) [2203348](#) [DF62W-2022SC](#) [1084018](#) [1029039](#) [1084017](#) [802-10-012-10-002000](#) [1112640](#) [1112639](#) [000-34000](#) [0009482033](#) [0009507031](#) [57102-S06-03LF](#) [57202-S52-04LF](#) [PCN6-15S-2.5E](#) [0039019024](#) [58102-G61-06LF](#) [582553-1](#) [0009485154](#) [0009508121](#) [0022285053](#) [0050291907](#) [018731A](#) [LY20-4P-DT1-P1E-BR](#) [02.125.8002.8](#) [60101931](#) [60598-1 \(Cut Strip\)](#) [M1625-3R/100](#) [61062-3](#) [61082-181009](#) [636-1427](#) [638009-1](#) [641938-9](#) [641991-4](#) [644168-1](#) [647662-1](#) [65039-019ELF](#) [65817-002LF](#) [65817-015LF](#) [65863-015LF](#) [66207-023LF](#) [67016-026LF](#) [67046-001LF](#) [67095-007LF](#) [67230-005LF](#)