

SMP TO 40 GHz

SMP Cable Assemblies

RF25S, RF405



VSWR

RF25S: Contact Samtec
RF405: Contact Samtec

SERIES	END 1 CONNECTOR	END 2 CONNECTOR	OVERALL LENGTH
RF25S = MWC-2550-01 microwave cable with 25 AWG solid FEP dielectric RF405 = RG 405 (.086") 24 AWG semi-flexible microwave cable	-00SJ7 = SMP Straight Jack -00RJ7 = SMP Right-angle Jack		-"XXXX" = Overall Length in millimeters -0100 (100 mm) 3.94" minimum
ALSO AVAILABLE			
SMA = RF25S			
SMA = RF405			

SMP Cable Connectors

PRF00



CONNECTORS FOR INDUSTRY STANDARD CABLES	
PRF00-J-C-EE-047A-RD	.047 Temp-Flex, low loss flexible, 29 AWG
PRF00-J-C-EE-085A-SD	.085, semi-rigid, 23 AWG
PRF00-PF-C-KK-047D-BD	.047, semi-rigid

J-C = Cable Jack
 EE = Plating (50 μ" Gold center contact & outer contact)
 KK = Plating (100 μ" Gold over Nickel center contact, passivated outer contact)
 BD = Bulkhead, Direct Solder
 SD = Straight, Direct Solder
 RD = Right-angle, Direct Solder

INTERFACE STANDARD (FULL DETENT)

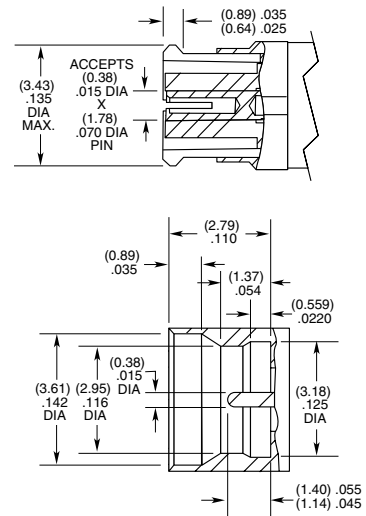

SMP TO 40 GHz

SMP Board Connectors SMP-TH, SMP-EM

Cable Mates:
RF405, RF255



SMP	GENDER	TYPE	PLATING	ORIENTATION	TERMINATION
	-PF = Plug, Full Detent -PL = Plug, Limited Detent -PS = Plug, Smooth Bore -PC = Plug, Catcher's Mitt	-P = PCB Mount	-GF = 10 μ " (0.25 μ m) Gold center contact, Gold Flash outer contact (-TH2 only) -HH = 30 μ " (0.76 μ m) Gold center and outer contact (-EM3)	-ST = Straight	-TH2 = Through-hole -EM3 = Drop-in Edge Mount (Not available with -PC)

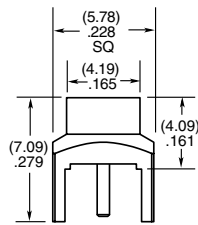

-PF/-PL/-PS-TH2

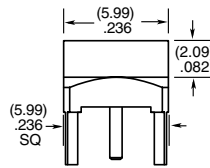

-PC-TH2

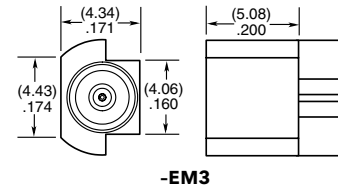

-EM3

SMP Bullet Adaptor SMP-B



SMP	J	TYPE	PLATING	ORIENTATION	BULLET LENGTH
		-B = Bullet Adaptor	-GF = 10 μ " (0.25 μ m) Gold center contact, Gold Flash outer contact	-ST = Straight	-0645 = 6.45 mm (.254") -1450 = 14.50 mm (.571")

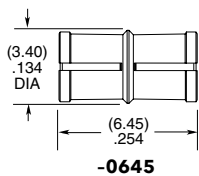

-0645

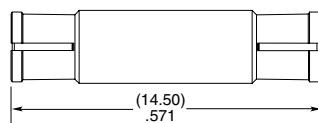

-1450

APPLICATION

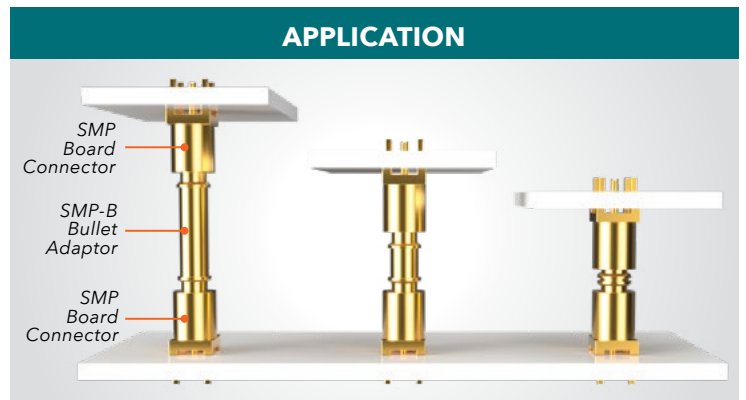

Compensates for axial & radial misalignment

X-ON Electronics

Largest Supplier of Electrical and Electronic Components

Click to view similar products for [RF Connectors / Coaxial Connectors](#) category:

Click to view products by [Samtec](#) manufacturer:

Other Similar products are found below :

[8915-1511-000](#) [89674-0827](#) [6001-7071-019](#) [6002-7051-003](#) [6002-7551-202](#) [6059674-1](#) [619550-1](#) [630059-000](#) [M39030/3-01N](#) [6500-7071-046](#) [6769](#) [CX050L2AQ](#) [7002-1541-010](#) [7002-1542-011](#) [7004-1512-000](#) [7009-1511-004](#) [7010-1511-000](#) [7029-1511-060](#) [7101-1541-010](#) [7101-1571-002](#) [7145-1521-002](#) [7203-1571-003](#) [7209-1511-011](#) [7210-1511-015](#) [7210-1511-019](#) [73137-5015](#) [73216-2241](#) [73404-2300](#) [7405-1521-005](#) [7405-1521-802](#) [8527](#) [8547](#) [FS11V](#) [877931](#) [8808-1511-001](#) [9074-9513-000](#) [9101-9573-002](#) [910A205F](#) [9130-9573-002](#) [PL11SC-026](#) [PL375-33](#) [PL40-5](#) [PL74C-221](#) [PL75MC-217](#) [PL803-7](#) [1200690078](#) [1-201144-1](#) [R107003010W](#) [R110A172100](#) [R112186000](#)