

(2.54 mm) .100"

TS, TD, HTS SERIES

# PRECISION MACHINED TERMINAL STRIPS

## SPECIFICATIONS

For complete specifications see [www.samtec.com?TS](http://www.samtec.com?TS), [www.samtec.com?TD](http://www.samtec.com?TD) or [www.samtec.com?HTS](http://www.samtec.com?HTS)

**Insulator Material:**  
Black G.F. Polyester (TS, TD)  
Black Liquid Crystal Polymer (HTS)

**Terminal Material:**  
Brass, except Style G is Phosphor Bronze

**Plating:**  
Au over 50 μ" (1.27 μm) Ni or Sn over 100 μ" (2.54 μm) Cu or 50 μ" (1.27 μm) Ni

**Operating Temp Range:**  
-55 °C to +125 °C with Gold  
-55 °C to +105 °C with Tin

**RoHS Compliant:**  
Yes

**Lead-Free Solderable:**

HTS: Yes  
TS, TD: No, Lead Wave Only

## RECOGNITIONS

For complete scope of recognitions see [www.samtec.com/quality](http://www.samtec.com/quality)



Mates with:  
SS, SD, HSS, SL,  
SDL, ESS, ESD

TYPE STRIP

1

NO. PINS PER ROW

PLATING OPTION

LEAD STYLE

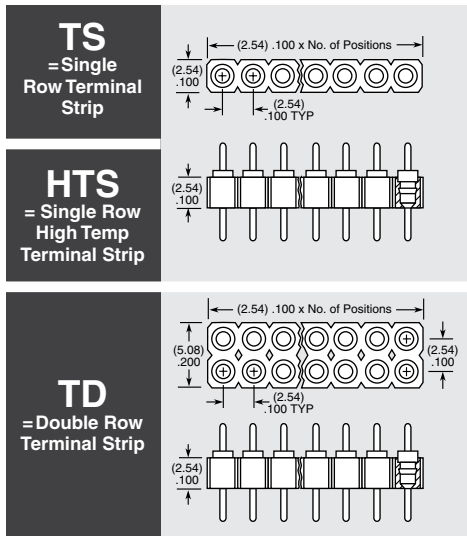

- G**  
= 20 μ" (0.51 μm) Gold  
Except -J & -L are 10 μ" (0.25 μm) Gold
- T**  
= Tin
- 01 thru 32**  
=TS Series
- 01 thru 36**  
=HTS & TD Series

**Note:**  
Some lengths, styles and options are non-standard, non-returnable.

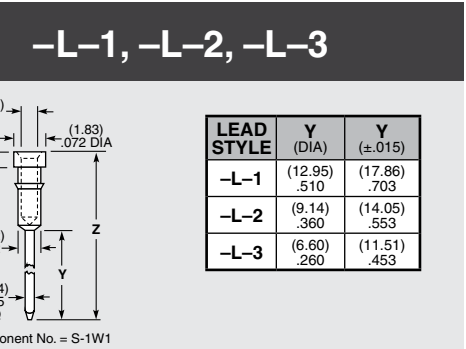
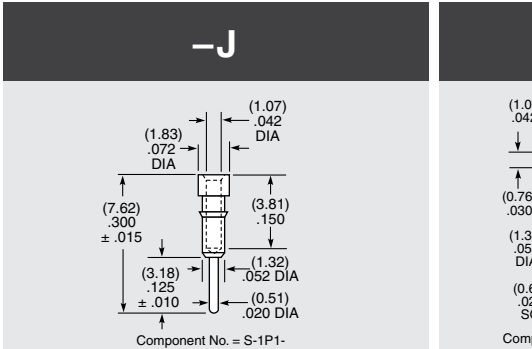
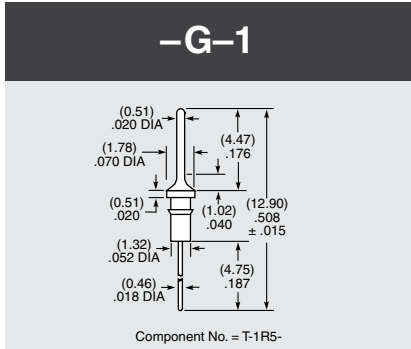
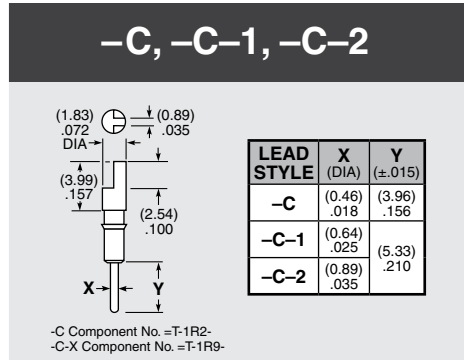
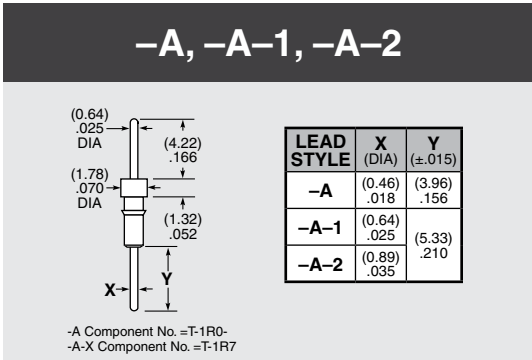
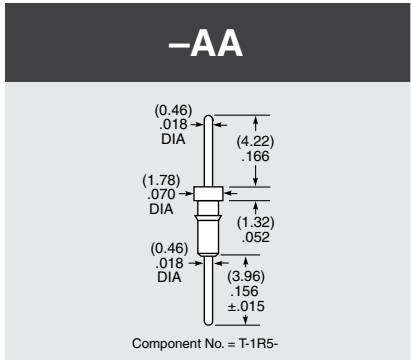

## X-ON Electronics

Largest Supplier of Electrical and Electronic Components

*Click to view similar products for [Headers & Wire Housings](#) category:*

*Click to view products by [Samtec](#) manufacturer:*

Other Similar products are found below :

[892-18-020-10-001101](#) [58102-G61-06LF](#) [582553-1](#) [0009485154](#) [009176003701906](#) [0050291907](#) [LY20-4P-DT1-P1E-BR](#) [02.125.8002.8](#)  
[609-3404](#) [61062-3](#) [61082-181009](#) [622-3653LF](#) [63453-116](#) [636-1030](#) [636-1427](#) [636-3427](#) [636-4007](#) [641938-9](#) [641991-4](#) [644827-2](#) [65817-](#)  
[010LF](#) [65817-015LF](#) [65863-015LF](#) [66207-023LF](#) [67095-007LF](#) [67601157](#) [68645-018](#) [68648-049](#) [70.362.1628.0](#) [70-4210](#) [70-4226B](#) [70-](#)  
[4853B](#) [707-5020](#) [707-5028](#) [71.350.2428.0](#) [71918-208LF](#) [71961-016LF](#) [733-134](#) [733-162](#) [754199-000](#) [760-3052](#) [79531-3000](#) [FCN-](#)  
[360C032-B](#) [FCN-367T-T012/H](#) [FCN-723D010/2](#) [80.063.4001.1](#) [800-90-001-10-001000](#) [800-90-010-10-002000](#) [801-43-002-10-013000](#)  
[801-43-006-10-002000](#)