

THROUGH-HOLE .025" SQ POST HEADER

(2.54 mm) .100" PITCH • TSW/HTSW SERIES

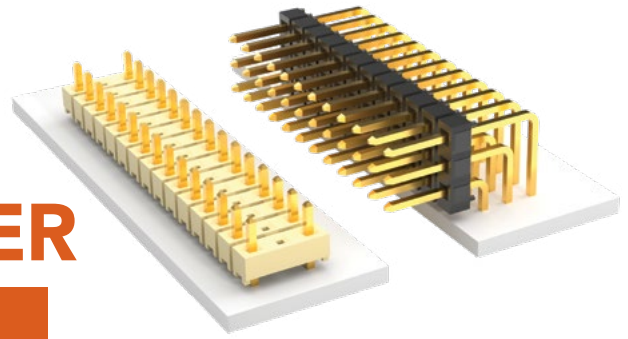

TSW/HTSW

Board Mates:

SSW, SSQ, SSM, ESW, ESQ,
BCS, BSW, CES, SLW

Cable Mates:

IDSD, IDSS

SERIES	PIN CENTERS	NO. PINS PER ROW	LEAD STYLE
--------	-------------	------------------	------------

TSW
= Standard Strip

HTSW
= Hi-Temp Strip

-1
= .100" (2.54 mm) Centers,
(All positions filled)

-2
= .200" (5.08 mm) Centers,
(Every other position filled)

01 thru 50
= .100" (2.54 mm)
Center Version

02 thru 25
= .200" (5.08 mm)
Center Version

Specify
LEAD STYLE
from chart

SPECIFICATIONS

Insulator Material:

TSW: PBT

HTSW: Natural LCP

Terminal Material:

Phosphor Bronze

Plating:

Au or Sn over 50 μ" (1.27 μm) Ni

Operating Temp Range:

-55 °C to +125 °C with Gold

-55 °C to +105 °C with Tin

Voltage Rating:

550 VAC mated with SSW;

500 VAC mated with

BCS or ESQ;

450 VAC -RA/-RE mated with

BCS or SSM

400 VAC mated with CES

Lead-Free Solderable:

HTSW: Yes

TSW: No, Lead Wave Only

CURRENT RATING (PER PIN)

TSW mated with

ESW	SSW	SLW	SSQ	SSM	BCS	SNT
5.2 A	5.7 A	5.2 A	6.3 A	5.2 A	4.6 A	4.3 A

2 POSITIONS POWERED



TSW

HTSW

Straight Pin Versions

ALSO AVAILABLE

Other Platings
(MOQ Required)

OTHER SOLUTIONS

Elevated Right-angle option
Shunts

STRAIGHT PIN VERSIONS			
LEAD STYLE	A	B	C
*-05	(8.51) .335	(3.30) .130	(2.67) .105
*-06	(7.62) .300	(2.41) .095	(2.67) .105
*-07	(10.92) .430	(2.54) .100	
*-08	(13.46) .530	(5.08) .200	
-09	(18.54) .730	(10.16) .400	
-10	(21.08) .830	(12.70) .500	(5.84) .230
-11	(23.62) .930	(15.24) .600	
-12	(26.16) 1.030	(17.78) .700	
-13	(31.24) 1.230	(22.86) .900	
-14	(13.46) .530		(8.13) .320
*-15		(2.79) .110	(13.21) .520
*-16	(18.54) .730	(7.87) .310	(8.13) .320
*-17	(21.08) .830		(15.74) .620
*-18	(23.62) .930	(2.79) .110	(18.29) .720

* Available with -LL (Locking Lead) Option
Specify -07 for best mate with IDXX Series IDC Cable

STRAIGHT PIN VERSIONS			
LEAD STYLE	A	B	C
*-19	(26.16) 1.030		(20.83) .820
*-20	(31.24) 1.230	(2.79) .110	(25.91) 1.020
*-21	(36.32) 1.430	(2.79) .110	(30.99) 1.220
*-22	(16.00) .630	(7.62) .300	(5.84) .230
*-23	(11.30) .445		
*-24	(12.15) .480	(2.92) .115	(6.73) .265
*-25	(16.00) .630	(5.33) .210	(8.13) .320
▲-26	(11.58) .456	(3.20) .126	
-27	(33.78) 1.330	(25.40) 1.000	(5.84) .230
-28	(28.70) 1.130	(20.32) .800	
-29	(33.78) 1.330	(23.11) .910	
-30	(28.70) 1.130	(18.03) .710	(8.13) .320
+--41	(9.27) .365	(0.89) .035	(5.84) .230
+--42	(11.94) .470	(1.27) .050	(8.13) .320

† Style -41 & -42 available with HTSW only.
▲ Except: Style -26 (0.46) .018 DIA Tail



PLATING OPTION

- F**
= Gold flash on post, Matte Tin on tail
- L**
= 10 μ" (0.25 μm) Gold on post, Matte Tin on tail
- G**
= 10 μ" (0.25 μm) Gold on post, Gold flash on balance
- T**
= Matte Tin

ROW OPTION

- S**
= Single Row
- D**
= Double Row
- T**
= Triple Row
- Q**
= Double Row
(5.08 mm).200" row space

OTHER OPTION

- RA or -RE**
= Right-angle
- NA**
= Right-angle
(Using straight body for coplanar mating with SSW-RA series)
- LL**
= Locking Lead
See charts for available styles.
Not available with single row 1 or 2 positions.
Recommended hole size
(1.02 mm ± 0.03 mm) .040" ± .001
- LC**
= Locking Clip
(Styles -08 thru -13 & -22 only)
(Requires 4 pin minimum)
(Not available with T, -Q, -RA or -RE)
- LA**
= -RA Option with -LL Option
- "XXX"**
= Polarized Position

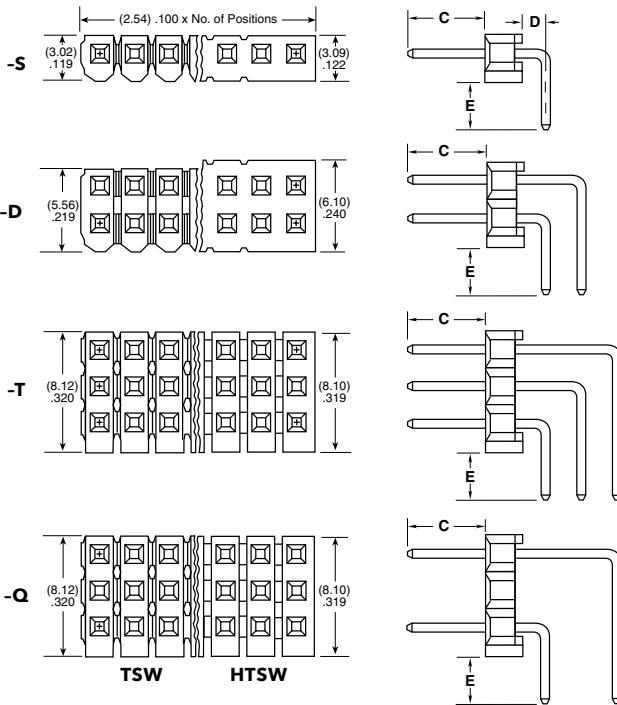

Right-Angle Versions

LEAD STYLE	D
-RA	(1.52) .060
-RE	(4.06) .160

RIGHT-ANGLE VERSIONS		
-RE LEAD STYLE	C	SINGLE E
-09		(4.83) .190
-10		(7.37) .290
-11	(5.84) .230	(9.91) .390
-12		(12.45) .490
-13		(17.53) .690
-16	(8.13) .320	(2.54) .100
-21		(22.61) .890
-22	(5.84) .230	(2.29) .090
-27		(20.07) .790
-28		(14.99) .590

-RA LEAD STYLE	RIGHT-ANGLE VERSIONS			
	SINGLE (-S)		DOUBLE (-D)	TRIPLE (-T & -Q)
	C	E	E	E
-08		(2.29) .090	(2.29) .090	(2.29) .090
-09		(7.37) .290	(7.37) .290	(7.37) .290
-10	(5.84) .230	(9.91) .390	(9.91) .390	(9.91) .390
-11		(12.45) .490	(12.45) .490	(12.45) .490
-12		(14.99) .590	(14.99) .590	(14.99) .590
-13		(20.07) .790	(20.07) .790	N/A
*-16	(8.13) .320	(5.08) .200	(5.08) .200	(5.08) .200
-21	(5.84) .230	(25.15) .990	N/A	N/A
*-22		(4.83) .190	(4.83) .190	(4.83) .190
*-25	(8.13) .320	(2.54) .100	(2.54) .100	(2.54) .100
-27	(5.84) .230	(22.61) .890	N/A	N/A
-28		(17.53) .690	(17.53) .690	
-29		(20.32) .800	N/A	
-30	(8.13) .320	(15.24) .600	(15.24) .600	

* Available with -LA (Locking Lead) Option

X-ON Electronics

Largest Supplier of Electrical and Electronic Components

Click to view similar products for [Headers & Wire Housings](#) category:

Click to view products by [Samtec](#) manufacturer:

Other Similar products are found below :

[892-18-020-10-001101](#) [58102-G61-06LF](#) [582553-1](#) [0009485154](#) [009176003701906](#) [0050291907](#) [LY20-4P-DT1-P1E-BR](#) [02.125.8002.8](#)
[609-3404](#) [61062-3](#) [61082-181009](#) [622-3653LF](#) [63453-116](#) [636-1030](#) [636-1427](#) [636-3427](#) [636-4007](#) [641938-9](#) [641991-4](#) [644827-2](#) [65817-](#)
[010LF](#) [65817-015LF](#) [65863-015LF](#) [66207-023LF](#) [67095-007LF](#) [67601157](#) [68645-018](#) [68648-049](#) [70.362.1628.0](#) [70-4210](#) [70-4226B](#) [70-](#)
[4853B](#) [707-5020](#) [707-5028](#) [71.350.2428.0](#) [71918-208LF](#) [71961-016LF](#) [733-134](#) [733-162](#) [754199-000](#) [760-3052](#) [79531-3000](#) [FCN-](#)
[360C032-B](#) [FCN-367T-T012/H](#) [FCN-723D010/2](#) [80.063.4001.1](#) [800-90-010-10-002000](#) [801-43-002-10-013000](#) [801-43-006-10-002000](#)
[801-93-011-10-001000](#)