

DO NOT SCALE FROM THIS PRINT

DIMENSIONS ARE IN INCHES UNLESS OTHERWISE NOTED TOLERANCES ARE:  
 ONE PLACE DECIMALS ± .1[2.54mm] THREE PLACE DECIMALS ± .005[.13mm] ANGLES ± 5°  
 TWO PLACE DECIMALS ± .01[.25mm] FOUR PLACE DECIMALS ± .0020[.05mm]

TITLE: HIGH TEMP 2mm TERMINAL STRIP (BOARD STACKING)

DWG NO: TW-XX-XX-X-X-XXX-XXX-XXX-XX SHEET 1 OF 3

TABLE 1						
LEAD STYLE	TERMINAL	"L"		"C"		
		OVERALL LENGTH				
-01	T-1S13-20-X-2	.3228	8.199	.100	2.54	
-02	T-1S13-02-X-2	.3770	9.576	.150	3.81	
-03	T-1S13-03-X-2	.5347	13.581	.150	3.81	
-04	T-1S13-06-X-2	.5550	14.097	.100	2.54	
-05	T-1S13-09-X-2	.5940	15.088	.100	2.54	
-06	T-1S13-10-X-2	.6730	17.094	.100	2.54	
-07	T-1S13-11-X-2	.7510	19.075	.100	2.54	
-08	T-1S13-12-X-2	.8300	21.082	.100	2.54	
-09	T-1S13-13-X-2	.4560	11.582	.100	2.54	
-10	T-1S13-14-X-2	.6140	15.596	.100	2.54	
-11	T-1S13-05-X-2	.3970	10.084	.100	2.54	
-12	T-1S13-16-X-2	1.110	28.194	.100	2.54	

NOTE: LEAD STYLE -08 & -12 NOT AVAILABLE IN -T,  
 -Q-5 & 6 ROW OPTION.

TW-XX-XX-X-X-XXX-XXX-XXX-XX

NO. OF POSITIONS  
 EXPRESSED IN # OF POS.  
 -01 THRU -50  
 "XX" = No. OF POS. X .07874 [2.00]

LEAD STYLE  
 (SEE TABLE 1)  
 (SEE \*NOTE)

PLATING  
 -G: 20µ" GOLD ON CONTACT AREA, 3µ" GOLD ON TAIL  
 -T: MATTE TIN CONTACT AND TAIL  
 -S: 30µ" SELECTIVE GOLD ON CONTACT AREA, MATTE TIN TAIL  
 -L: 15µ" SELECTIVE GOLD ON CONTACT AREA, MATTE TIN TAIL  
 -TL: TIN/LEAD (90/10+/-5%) CONTACT AND TAIL  
 -F: 3µ" FLASH GOLD ON CONTACT AREA, MATTE TIN TAIL  
 -H: 30µ" GOLD ON CONTACT AREA, 3µ" GOLD ON TAIL  
 -STL: 30µ" SELECTIVE GOLD ON CONTACT AREA, TIN/LEAD (90/10+/-5%) TAIL (-08 & -12 LEAD STYLES ONLY)  
 -TM: MATTE TIN CONTACT AND TAIL  
 -LM: 15µ" SELECTIVE GOLD ON CONTACT AREA, MATTE TIN TAIL  
 -FM: 3µ" FLASH GOLD ON CONTACT AREA, MATTE TIN TAIL  
 -SM: 30µ" SELECTIVE GOLD ON CONTACT AREA, MATTE TIN TAIL

OPTION  
 \*\* -MW: METAL WASHER (NOT AVAILABLE IN -12 LEAD STYLE) (NOT AVAILABLE FOR -S VERSION) (SEE FIG. 2, SHT. 3) (.090 [2.29] MIN TAIL) (.300 [7.62] MAX TAIL ONLY FOR -T & -TL OPTIONS.) (ALL -MW OPTIONS ARE TO BE TUBED)

POLARIZATION OPTION  
 SPECIFY POS. TO BE REMOVED (SEE FIGURE 1)

TAIL LENGTH

SPACE OPTION  
 -S, -D, -Q: (.120 MIN.)  
 -T, -5, -6: (.160 MIN.)  
 MAX = 'L' - .050

ROW OPTION  
 -S: SINGLE (USE BODY TMM-50-S)  
 -D: DOUBLE (USE BODY TMM-50-D: .120-.1599 BOARD SPACE (ABOVE .160 MIN USE BODY TMMC-50-D) (CAN SUB TMMH-50-D OR TMMH-50-D-LC FOR TMMC-50-D)  
 -T: TRIPLE ( USE BODY TMMH-50-T)  
 -Q: QUAD (USE BODY TMM-50-Q)  
 -5: FIVE ROW (USE BODY TMMH-50-5)  
 -6: SIX ROW (USE BODY TMMH-50-6)

FIG 1  
 SCALE: .75x  
 (SEE NOTE 6)

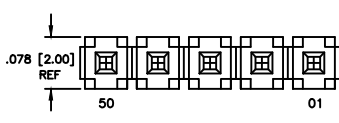

SINGLES

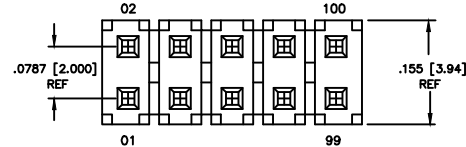

DOUBLES

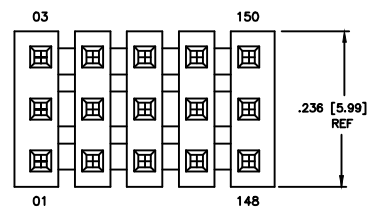

TRIPLES

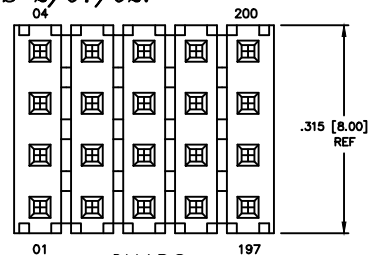

QUADS

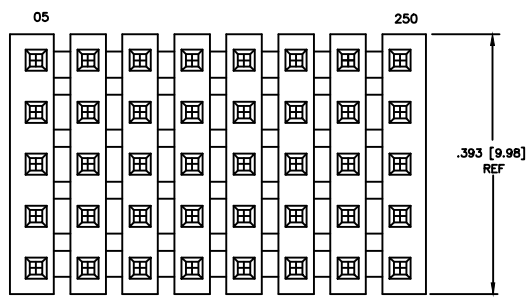

FIVE ROW

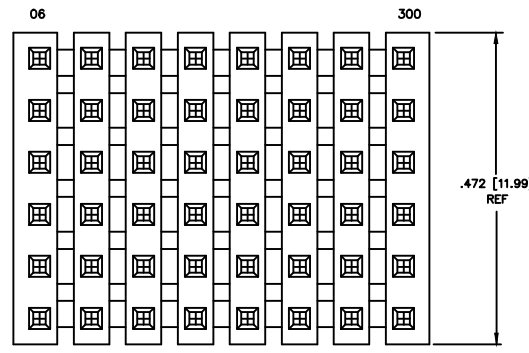

SIX ROW

FIG 1

\*\* - MW OPTION, DO NOT DESIGN IN. SAMTEC WILL ONLY SUPPORT EXISTING BUSINESS 2/07/02.

- NOTES:
- 1.) MAX ALLOWABLE BOW: .005 IN/IN AFTER ASSEMBLY.
  - 2.) MAX PIN ROTATION IN BODY: 2°.
  - 3.) PUSHOUT FORCE SHALL BE 1 lb. MIN.
  - 4.) (C) REPRESENTS A CRITICAL DIMENSION FOR STATISTICAL PROCESS CONTROL USE.
  - 5.) ON -S, -L, -F, & -STL PLATING, GOLD TO GO IN CONTACT AREA WHICH IS OPPOSITE THE GIVEN TAIL LENGTH. FOR -G & -H, HEAVY GOLD TO GO IN CONTACT AREA WHICH IS OPPOSITE THE GIVEN TAIL LENGTH. NOTE DOES NOT APPLY TO -T & -TL PLATING.
  - 6.) TOP VIEW (VIEW OF CONTACT AREA, OPPOSITE VIEW OF CUSTOMER SPECIFIED TAIL (SEE PAGE 2)).
  - 7.) .020 MAX FLASH
  - 8.) NOTE DELETED
  - 9.) INSULATOR MATERIAL: BLACK, LCP, UL 94 VO
  - 10.) FOR ADDED MECHANICAL STABILITY, SAMTEC RECOMMENDS MECHANICAL BOARD SPACERS BE USED IN APPLICATIONS WITH GOLD OR SELECTIVE GOLD PLATED CONNECTORS. CONTACT IPG@SAMTEC.COM FOR MORE INFORMATION.

**PROPRIETARY NOTE**  
 THIS DOCUMENT CONTAINS INFORMATION CONFIDENTIAL AND PROPRIETARY TO SAMTEC INC. AND SHALL NOT BE REPRODUCED OR TRANSFERRED TO OTHER DOCUMENTS OR DISCLOSED TO OTHERS OR USED FOR ANY PURPOSE OTHER THAN THAT FOR WHICH IT WAS OBTAINED WITHOUT THE EXPRESSED WRITTEN CONSENT OF SAMTEC INC.



520 PARK EAST BLVD. NEW ALBANY, INDIANA 47150  
 PHONE (812) 944-6733 P.O. BOX 1147  
 CODE 55322

REV. BG

<small>DIMENSIONS ARE IN INCHES UNLESS OTHERWISE NOTED TELEDIMENSIONS ARE:</small> ONE PLACE DECIMALS ±.1(2.54mm) THREE PLACE DECIMALS ±.005(.13mm) TWO PLACE DECIMALS ±.01(.25mm) FOUR PLACE DECIMALS ±.002(.05mm)	<small>TOLERANCES ARE:</small> ANGLES ± 5°	TITLE: HIGH TEMP 2mm TERMINAL STRIP (BOARD STACKING)	DWG NO: TW-XX-XX-X-Y-XXX-XXX-XXX-XX SHEET 2 OF 3
---	---	---	--

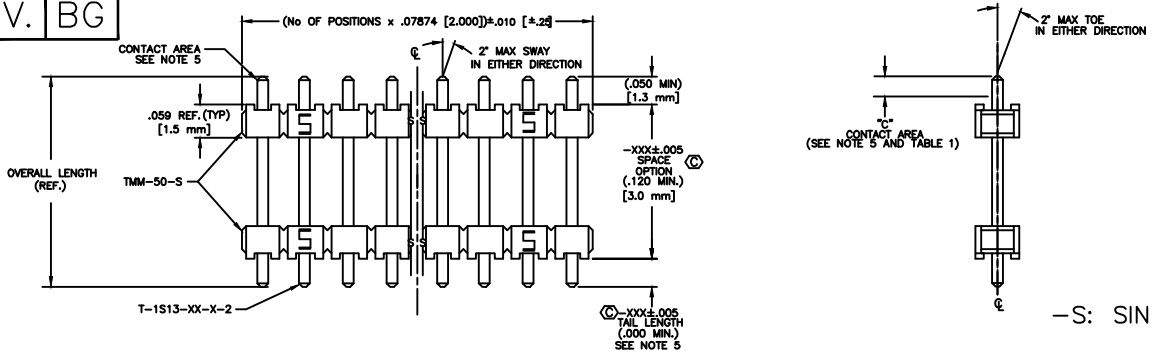

-S: SINGLES

-T: TRIPLE  
 -5: FIVE ROW  
 -6: SIX ROW

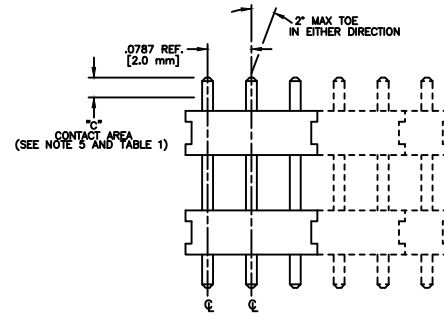
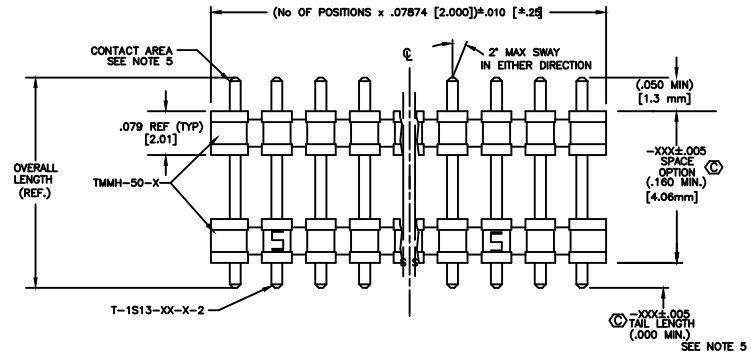

-D: DOUBLE  
 -Q: QUAD

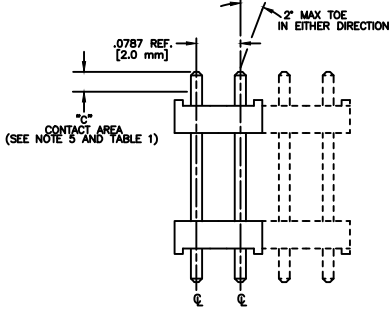
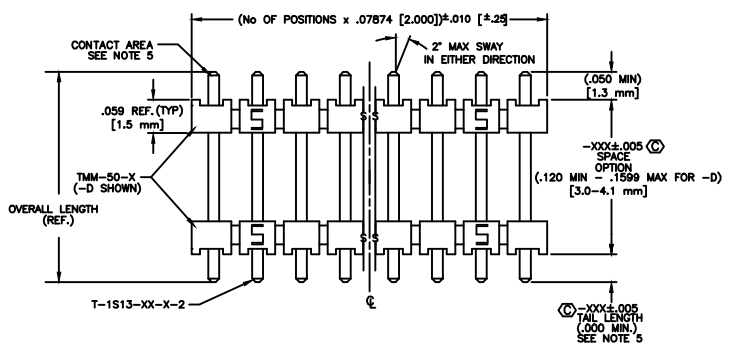

-D: DOUBLE

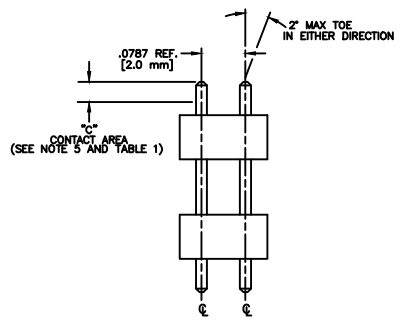
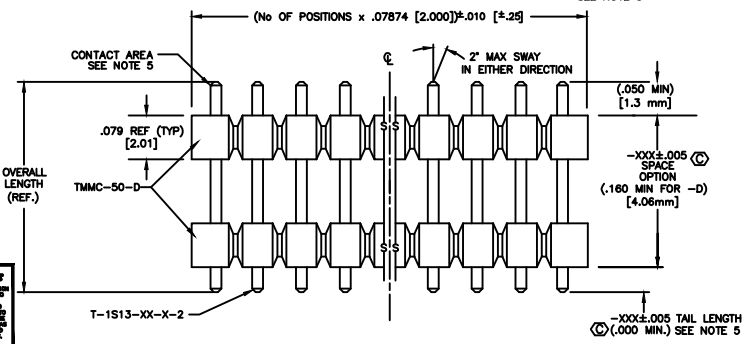

**PROPRIETARY NOTE**  
 THE INFORMATION CONTAINED HEREIN IS THE PROPERTY OF SAMTEC CORPORATION AND IS TO BE USED ONLY FOR THE PURPOSES AND IN ACCORDANCE WITH THE TERMS AND CONDITIONS OF THE LICENSE AGREEMENT. ANY UNAUTHORIZED REPRODUCTION OR DISTRIBUTION OF THIS INFORMATION IS STRICTLY PROHIBITED. SAMTEC CORPORATION, 520 PARK EAST BLVD., NEW ALBANY, INDIANA 47150, PHONE (812) 944-8733, F.O. BOX 1147, CODE 55322.

PLOT SCALE 1=11  
**samtec**  
 EMS/PROD/ASSEMBLY/2MM  
 TW-ASM2  
 520 PARK EAST BLVD. NEW ALBANY, INDIANA 47150  
 PHONE (812) 944-8733 F.O. BOX 1147  
 CODE 55322  
 MADE BY: MATT CARTER 6-19-98  
 TW-XX-XX-X-Y-XXX-XXX-XXX-XX  
 SHEET 2 OF 3

**PROPRIETARY NOTE**  
 THIS DOCUMENT CONTAINS PROPRIETARY INFORMATION AND IS THE PROPERTY OF SAMTEC INC. AND SHALL NOT BE REPRODUCED OR TRANSMITTED IN ANY FORM OR BY ANY MEANS, ELECTRONIC OR MECHANICAL, INCLUDING PHOTOCOPYING, RECORDING, OR BY ANY INFORMATION STORAGE AND RETRIEVAL SYSTEM. PERMISSION TO REPRODUCE THIS DOCUMENT OR EXCERPTS THEREFROM MUST BE OBTAINED FROM SAMTEC INC. WRITTEN CONSENT OF SAMTEC INC. IS REQUIRED BEFORE THE EXPOSED

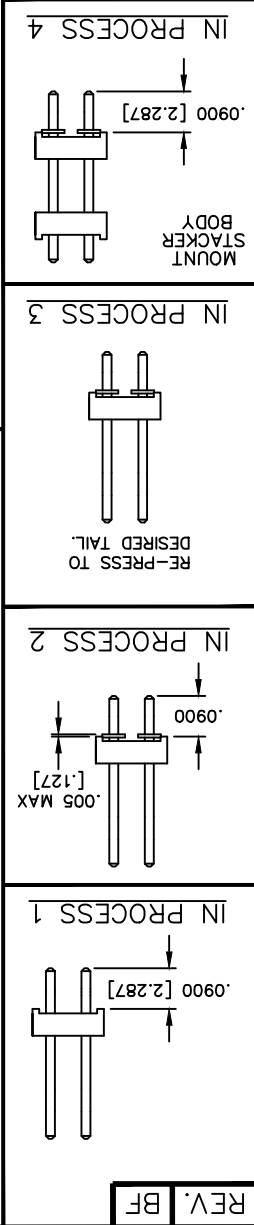

\*\*

ONLY SUPPORT EXISTING BUSINESS 2/07/02. — MW OPTION, DO NOT DESIGN IN. SAMTEC WILL

(5 POS PER ROW MIN / 30 POS PER ROW MAX)

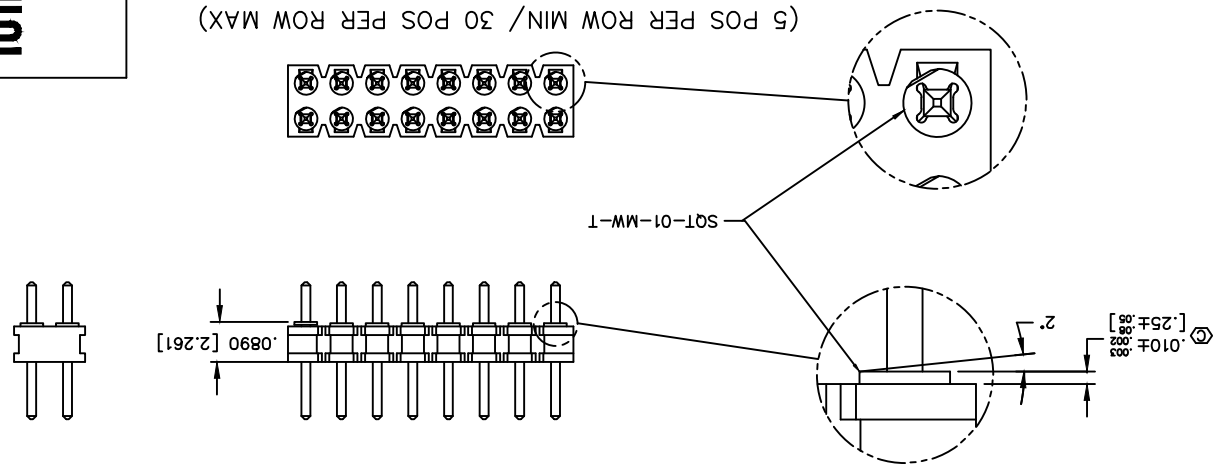

—MW METAL WASHERS USING TMMH OR TMMC BODY

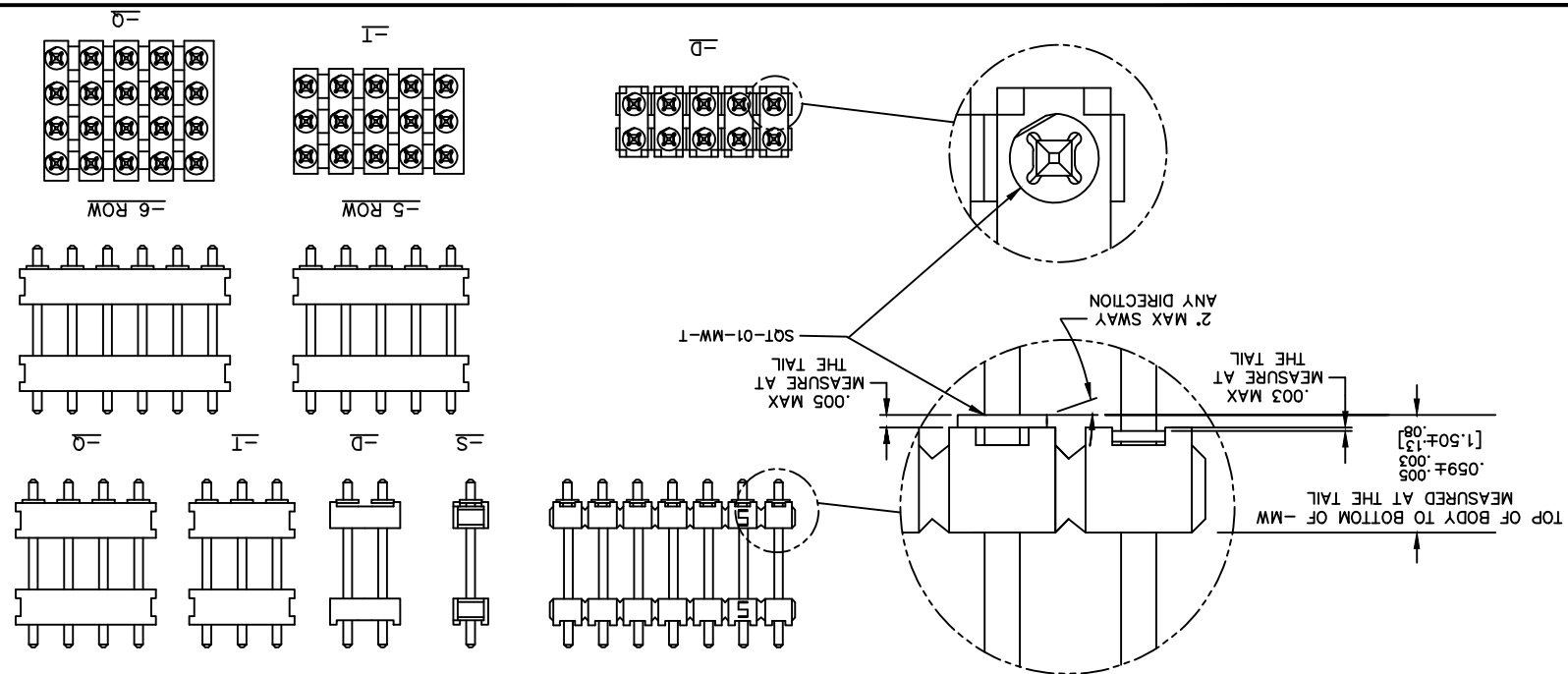

FIG 2  
 \*\* -MW: METAL WASHER USING TMM BODY (ONE PER POSITION) (30 POS MAX)

UNLESS OTHERWISE NOTED  
 DIMENSIONS ARE IN INCHES  
 ONE PLACE DECIMALS ±.1 [2.5] THREE PLACE DECIMALS ±.005 [.13]  
 TWO PLACE DECIMALS ±.01 [2.5] FOUR PLACE DECIMALS ±.0020 [.05]  
 ANGLES ± 2°  
 TOLERANCES ARE:

TITLE: 2mm TERMINAL STRIP ASSEMBLY  
 DWG NO:

TM-XX-XX-X-X-XX-XX-XX-XX  
 SHEET 3 OF 3

EXISPROD\ASSEMBLY\2MM  
 TM-ASM3  
**Samtec**  
 520 PARK EAST BLDG, NEW ALBANY, INDIANA 47150  
 PHONE (812) 944-6733 P.O. BOX 1147  
 CODE 55322  
 MADE BY: REIDINGER 11-2-90  
 TM-XX-XX-X-X-XX-XX-XX-XX  
 SHEET 3 OF 3

## X-ON Electronics

Largest Supplier of Electrical and Electronic Components

*Click to view similar products for [Headers & Wire Housings](#) category:*

*Click to view products by [Samtec](#) manufacturer:*

Other Similar products are found below :

[95000-104TRLF](#) [10135584-644402LF](#) [DF62W-EP2022PCA](#) [95000-106TRLF](#) [DF62W-2022SCA](#) [DF62W-EP2022PC](#) [2203348](#) [DF62W-2022SC](#) [1084018](#) [1029039](#) [1084017](#) [802-10-012-10-002000](#) [1112640](#) [1112639](#) [891-007-9SS-BST1T](#) [000-34000](#) [0008550134](#) [0009482033](#) [0009507031](#) [57102-F02-18ULF](#) [57102-S06-03LF](#) [57202-S52-04LF](#) [PCN6-15S-2.5E](#) [0039019024](#) [58102-G61-06LF](#) [582553-1](#) [0009485154](#) [0009508121](#) [009176003701906](#) [0022285053](#) [0050291907](#) [018731A](#) [LY20-4P-DT1-P1E-BR](#) [02.125.8002.8](#) [60101931](#) [60598-1 \(Cut Strip\)](#) [M1625-3R/100](#) [61062-3](#) [61082-181009](#) [CSU011177004](#) [636-1427](#) [638009-1](#) [641938-9](#) [641991-4](#) [644168-1](#) [644827-2](#) [647662-1](#) [65039-019ELF](#) [65692-001LF](#) [65781-018](#)