

REVISION G

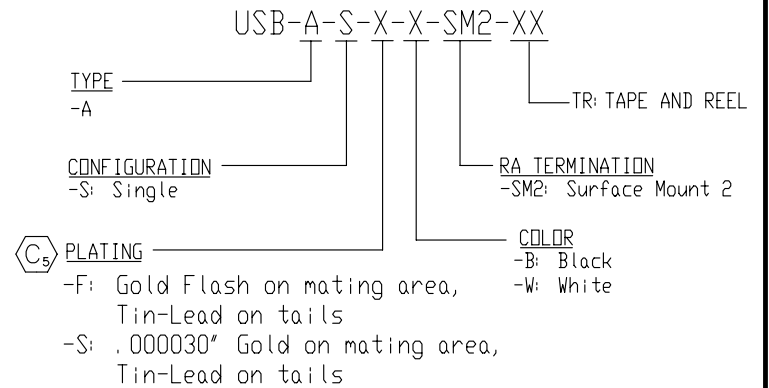

DO NOT SCALE FROM THIS PRINT

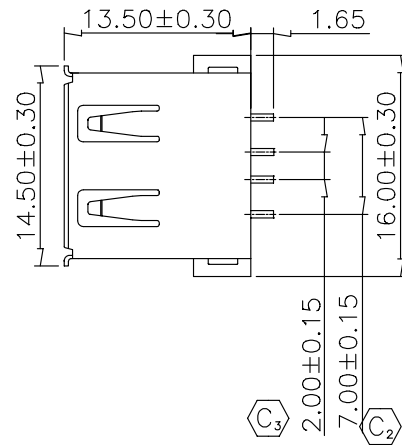
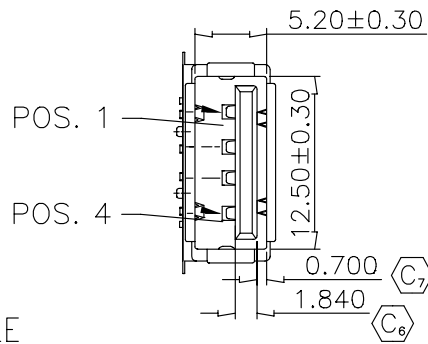
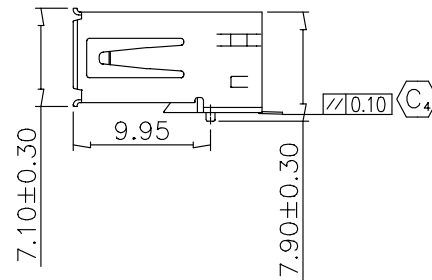

NOTES:

1. Ⓢ REPRESENTS CRITICAL DIMENSION.
2. VERIFY -S PLATING, VISUALLY CHECK FOR -F GOLD.

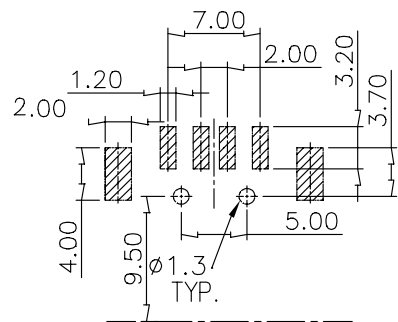

RECOMMENDED PCB LAYOUT
TOP VIEW

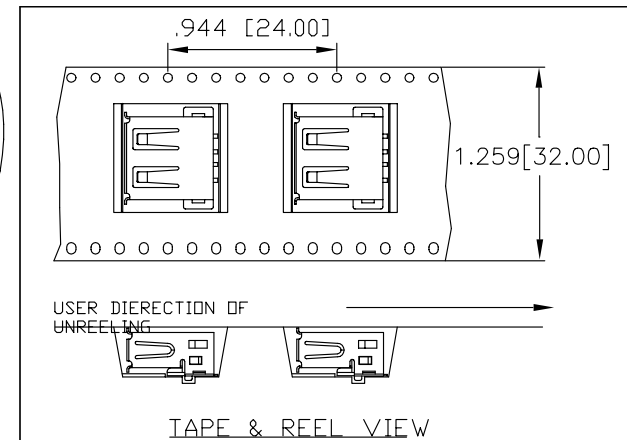
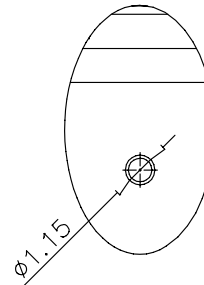
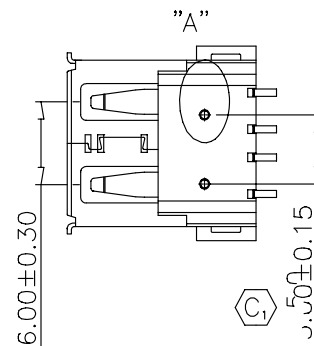

UNLESS OTHERWISE SPECIFIED, DIMENSIONS ARE IN MM. TOLERANCES ARE:

DECIMALS ANGLES
.X: ±.15 2°
.XX: ±.08
.XXX: ±.03

PROPRIETARY NOTE
THIS DOCUMENT CONTAINS INFORMATION CONFIDENTIAL AND PROPRIETARY TO SAMTEC INC. AND SHALL NOT BE REPRODUCED OR TRANSFERRED TO OTHER DOCUMENTS OR DISCLOSED TO OTHERS OR USED FOR ANY PURPOSE OTHER THAN THAT FOR WHICH IT WAS OBTAINED WITHOUT THE EXPRESSED WRITTEN CONSENT OF SAMTEC INC.



520 PARK EAST BLVD. NEW ALBANY, IN 47150
(812) 944-6733 P.O. BOX 1147 TWX: 810-540-4085

CODE: 55322

DO NOT SCALE DRAWING
INSULATOR: PBT (RATED UL 94V-0)
CONTACT: PHOS BRONZE
BACK SHIELD: NICKEL PLATED PHOS BRONZE
FRONT SHIELD: TIN PLATED PHOS BRONZE
MAX FLASH ALLOWED: .051
MAX GATE VESTIGE: .051
F:\DWG\EXISPROD\ASSEMBLY\10\USB

SHEET SCALE: 1:2

DESCRIPTION:
USB A, Single, Surface Mount 2

DWG. NO.
USB-A-S-X-X-SM2-XX

BY: J. Riley 05/22/04 SHEET 1 OF 1

X-ON Electronics

Largest Supplier of Electrical and Electronic Components

Click to view similar products for [USB Connectors](#) category:

Click to view products by [Samtec](#) manufacturer:

Other Similar products are found below :

[65-647-8-BK-BU](#) [950](#) [952](#) [E8144-B01021-L](#) [A-USB B-TOP-C](#) [MUSBA511N5](#) [MUSBD11135](#) [217450-1](#) [KMBVX-TH-5S-B30](#) [896-30-004-00-000000](#) [KUSBVX-BS1N-W30](#) [KUSBX-AP-KIT-SCBLK](#) [KUSBX-AS2N-W](#) [KUSBX-SMT2AP1S-W](#) [KUSBX-SMT2AP1S-W30](#) [935](#) [957](#) [30-498-6](#) [SK-60A-2](#) [17-210051](#) [1734082-1](#) [30-1574](#) [30-470](#) [30-489](#) [30-541](#) [30-572-3](#) [A-USB A-2P-C](#) [MIKROE-1451](#) [USBFTV2PEM2G](#) [USBFTVC6ZN](#) [KUSBX-AS2N-W30](#) [KUSBX-SLAS1N-W](#) [KUSBX-SMT-AS1N-W30](#) [4689-1](#) [1-1734084-2](#) [E8110-001-01](#) [33UBARS1-04SW11](#) [33UBAR-04SW11](#) [USBF21ZNSCC](#) [USBBFTV6ZC](#) [10135326-001LF](#) [USB-A-S-F-B-VT](#) [925](#) [4198](#) [690-024-633-031](#) [KUSBEX-BSFS1N-W](#) [USBFTVC6MRG](#) [UA-20BMFA-SL8001](#) [17-250101](#) [USBFTVC7ZC](#)