

SUGGESTED PANEL CUTOUT DIMENSIONS

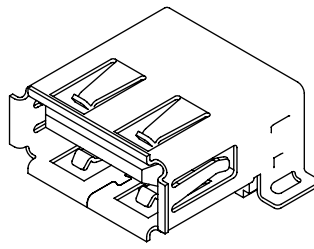

USB-A-S-X-X-SM2-X-XX

TYPE
-A

CONFIGURATION
-S: SINGLE

PLATING SPECIFICATION
C4

-F: GOLD FLASH ON MATING AREA, MATTE TIN ON TAIL
-S: SELECTIVE, .000030 GOLD ON MATING AREA, MATTE TIN ON TAIL

PACKAGING

BLANK: TRAY (SEE NOTES 4 & 6)
-TR: TAPE & REEL (SEE NOTES 6 & 7)
-FR: FULL REEL QTY TAPE & REEL (SEE NOTES 6 & 7)

COMPLIANCE

-R: ROHS COMPLIANT (SEE NOTE 5)

TERMINATION

-SM2: SURFACE MOUNT 2

COLOR

-B: BLACK
-W: WHITE

DO NOT SCALE FROM THIS PRINT

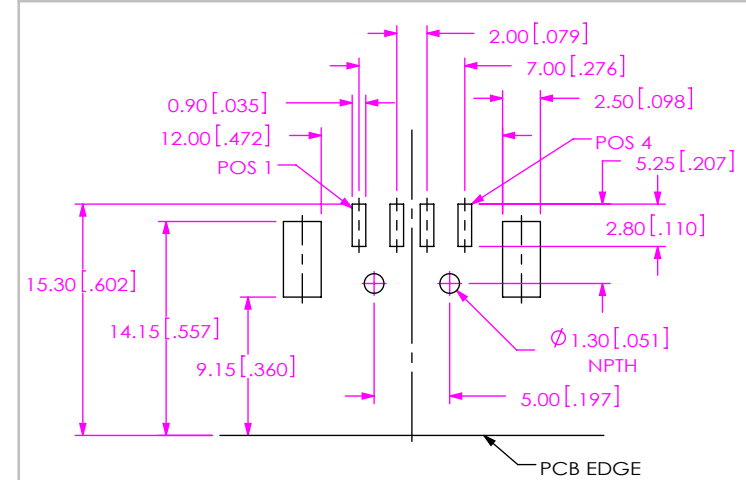
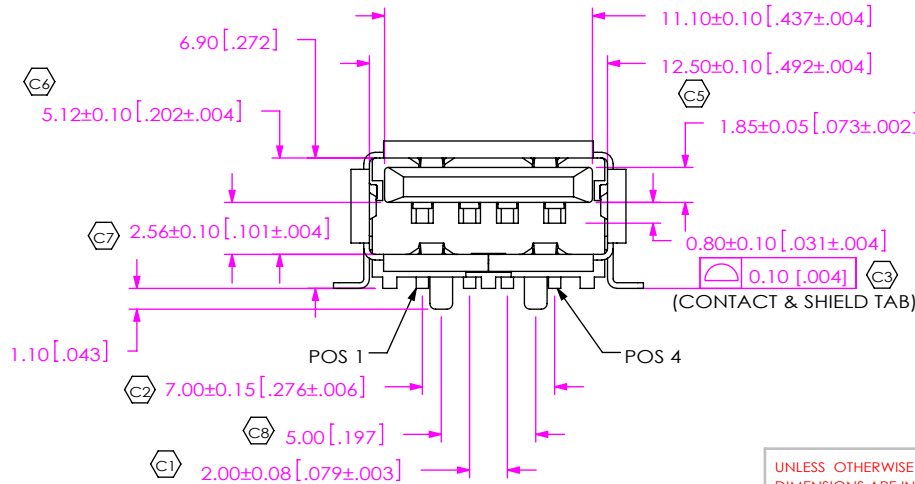
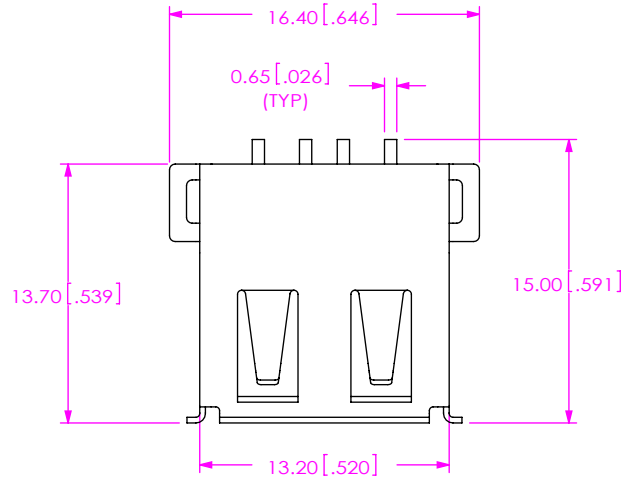

RECOMMENDED PCB LAYOUT

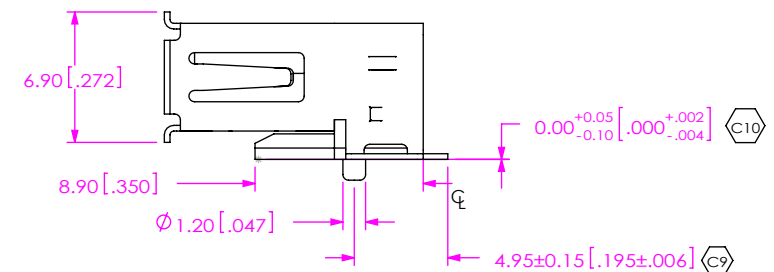

NOTES:

1. C REPRESENTS CRITICAL DIMENSION.
2. DELETED.
3. DELETED.
4. TRAYS ARE STANDARD PACKAGING.
5. ALL PARTS ROHS COMPLIANT WITH OR WITHOUT -R.
6. ORDERS WILL BE PACKAGED ACCORDING TO THE SAMTEC PACKAGING EFFICIENCY STANDARDS (SPES) FOUND ON WWW.SAMTEC.COM.
7. ATTACH LABEL TO EACH REEL.

UNLESS OTHERWISE SPECIFIED, DIMENSIONS ARE IN MILLIMETERS.
TOLERANCES ARE:
DECIMALS ANGLES
X.X: ±0.3 [01] 2°
X.XX: ±0.13 [005]
X.XXX: ±0.051 [0020]

PROPRIETARY NOTE

THIS DOCUMENT CONTAINS CONFIDENTIAL AND PROPRIETARY INFORMATION AND ALL DESIGN, MANUFACTURING, REPRODUCTION, USE, PATENT RIGHTS AND SALES RIGHTS ARE EXPRESSLY RESERVED BY SAMTEC, INC. THIS DOCUMENT SHALL NOT BE DISCLOSED, IN WHOLE OR PART, TO ANY UNAUTHORIZED PERSON OR ENTITY NOR REPRODUCED, TRANSFERRED OR INCORPORATED IN ANY OTHER PROJECT IN ANY MANNER WITHOUT THE EXPRESS WRITTEN CONSENT OF SAMTEC, INC.



520 PARK EAST BLVD. NEW ALBANY, IN 47150
PHONE: 812-944-6733 FAX: 812-948-5047
e-Mail: info@SAMTEC.com code: 55322

MATERIAL: DO NOT SCALE DRAWING SHEET SCALE: 2:1
HOUSING: HI-TEMP NYLON UL 94V-0
CONTACT: COPPER ALLOY
SHELL: COPPER ALLOY

DESCRIPTION: USB A, SINGLE, SURFACE MOUNT 2

DWG. NO. USB-A-S-X-X-SM2-X-XX

BY: B.HARPENAU 2/24/2006 SHEET 1 OF 2

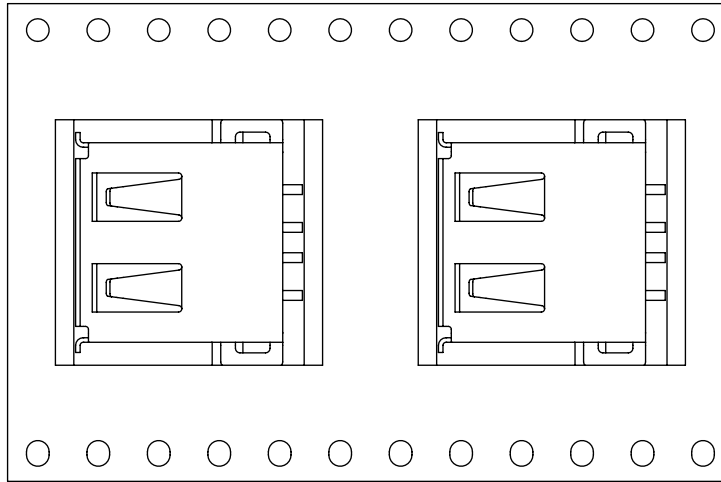

USER DIRECTION OF UN-REELING →
POCKET NOT DETAILED

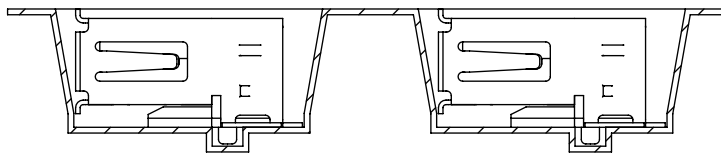

-TR: TAPE & REEL

• PROPRIETARY NOTE •
THIS DOCUMENT CONTAINS CONFIDENTIAL AND PROPRIETARY INFORMATION AND ALL DESIGN, MANUFACTURING, REPRODUCTION, USE, PATENT RIGHTS AND SALES RIGHTS ARE EXPRESSLY RESERVED BY SAMTEC, INC. THIS DOCUMENT SHALL NOT BE DISCLOSED, IN WHOLE OR PART, TO ANY UNAUTHORIZED PERSON OR ENTITY NOR REPRODUCED, TRANSFERRED OR INCORPORATED IN ANY OTHER PROJECT IN ANY MANNER WITHOUT THE EXPRESS WRITTEN CONSENT OF SAMTEC, INC.

DO NOT SCALE DRAWING

SHEET SCALE: 1:1

samtec

520 PARK EAST BLVD, NEW ALBANY, IN 47150
PHONE: 812-944-6733 FAX: 812-948-5047
e-Mail: info@SAMTEC.com code: 55322

DESCRIPTION: USB A, SINGLE, SURFACE MOUNT 2

DWG. NO. USB-A-S-X-X-SM2-X-XX

BY: B.HARPENAU 2/24/2006 SHEET 2 OF 2

X-ON Electronics

Largest Supplier of Electrical and Electronic Components

Click to view similar products for [USB Connectors](#) category:

Click to view products by [Samtec](#) manufacturer:

Other Similar products are found below :

[65-647-8-BK-BU](#) [950](#) [952](#) [E8144-B01021-L](#) [A-USB B-TOP-C](#) [MUSBA511N5](#) [MUSBD11135](#) [217450-1](#) [KMBVX-TH-5S-B30](#) [896-30-004-00-000000](#) [KUSBVX-BS1N-W30](#) [KUSBX-AP-KIT-SCBLK](#) [KUSBX-AS2N-W](#) [KUSBX-SMT2AP1S-W](#) [KUSBX-SMT2AP1S-W30](#) [935](#) [957](#) [30-498-6](#) [SK-60A-2](#) [17-210051](#) [1734082-1](#) [30-1574](#) [30-470](#) [30-489](#) [30-541](#) [30-572-3](#) [A-USB A-2P-C](#) [MIKROE-1451](#) [USBFTV2PEM2G](#) [USBFTVC6ZN](#) [KUSBX-AS2N-W30](#) [KUSBX-SLAS1N-W](#) [KUSBX-SMT-AS1N-W30](#) [4689-1](#) [1-1734084-2](#) [E8110-001-01](#) [33UBARS1-04SW11](#) [33UBAR-04SW11](#) [USBF21ZNSCC](#) [USBBFTV6ZC](#) [10135326-001LF](#) [USB-A-S-F-B-VT](#) [925](#) [4198](#) [690-024-633-031](#) [KUSBEX-BSFS1N-W](#) [USBFTVC6MRG](#) [UA-20BMFA-SL8001](#) [17-250101](#) [USBFTVC7ZC](#)