

Multi Layer Ceramic Capacitors

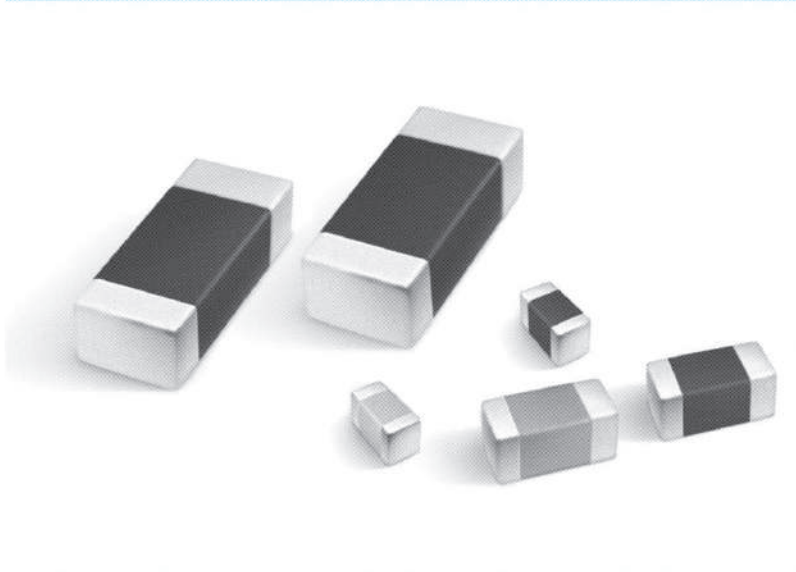

SMD Type	5
SMD Type-High Voltage	13
SMD Type-High Frequency	26
Automotive Application	29

Multi Layer Ceramic Capacitors

Introduction

SAMWHA's series of multilayer ceramic(MLC) chip capacitors is designed to meet a wide variety of need. Multilayer ceramic chip capacitors are available in both class I and class II formulations. Temperature compensation formulations are class I and temperature stable and general application formulations are classified at class II. The class I multilayer ceramic capacitors are COG with negligible dependence of electrical properties on temperature, voltage, frequency. The most of commonly used class II dielectric are X7R, X5R and Y5V. The X7R provides intermediate capacitance values which vary $\pm 15\%$ over the temperature range of -55°C to 125°C . The X5R provides intermediate capacitance values which vary $\pm 15\%$ over the temperature range of -55°C to 85°C . The Y5V provides the highest capacitance value which vary from 22% to -82% over the temperature range of -30°C to 85°C . All class II capacitors vary in capacitance value under the influence of temperature, operating voltage and frequency. We offer a complete line of products for both class I and II .

Features

- Samwha's high density ceramic bodies offer superior performance and reliability
- Samwha offer various temperature characteristics, rated voltage and packing method
- Material with high dielectric constant and superior manufacturing technology allows very high values in a small size
- Solder coated terminals offer superior solderability

Applications

Wide applications throughout commercial and industrial market.

- Communication products like Cellular Phone, Pager, Codeless phone
 - Multimedia products like DVD, CD-ROM, FDD, HDD, Game machine, Computer, Note book, Digital camera, LCD
 - Audio visual products like TV, Camcorder, Minidisk, MP3 Player
 - Communication products like Electronic tuner, Duplexer, VCXO, TCXO, Modem
 - OA equipment products like Printer, Copy Machine, Fax Machine
- ※ special specification like a Automobile, Medical, Military, Aviation should be discuss with our sales representatives

SMD Type

SMD Type

Shape & Dimensions

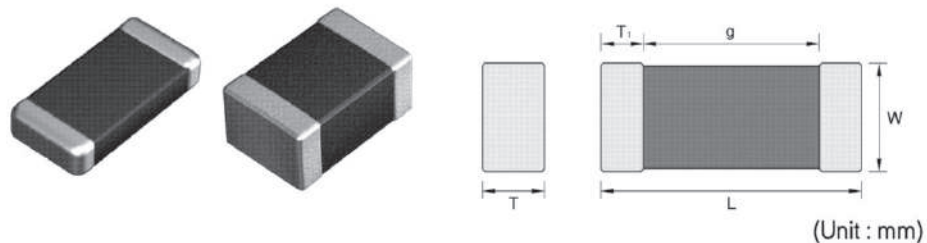

(Unit : mm)

Code(inch)	Dimensions				
	Length		Width		T1(min)
	L	Tol(±)	W	Tol(±)	
0603(0201)	0.60	0.03	0.30	0.03	0.05
1005(0402)	1.00	0.05	0.50	0.05	0.05
1608(0603)	1.60	0.15	0.80	0.10	0.10
2012(0805)	2.00	0.20	1.25	0.15	0.10
3216(1206)	3.20	0.30	1.60	0.20	0.15
3225(1210)	3.20	0.40	2.50	0.25	0.15
4520(1808)	4.50	0.40	2.00	0.25	0.20
4532(1812)	4.50	0.40	3.20	0.30	0.20
5750(2220)	5.70	0.50	5.00	0.40	0.30

*1608 Size $\geq 10\mu F \Rightarrow W : 0.8 \pm 0.15, T : 0.8 \pm 0.15$

How to Order(Product Identification)

CS 1608 X7R 104 K 160 N R B

1 2 3 4 5 6 7 8 9

1 Type

CS : SMD
SA : ARRAY

2 Size Code

This is expressed in tens of a millimeter.
The first two digits are the length, the last two digits are width.

Size(mm)	0603	1005	1608	2012	3216	3225	4520	4532	5750
----------	------	------	------	------	------	------	------	------	------

3 Temperature Coefficient Code

Temperature Characteristic	Temperature Range	Capacitance Change or Temperature Coefficient	Operating Temperature Range
C0G	-55 to 125°C	0±30ppm/°C	-55 to 125°C
X7R	-55 to 125°C	±15%	-55 to 125°C
X5R	-55 to 85°C	±15%	-55 to 85°C
Y5V	-30 to 85°C	+22, -82%	-30 to 85°C

4 Capacitance Code(Pico Farads)

The nominal capacitance value in pF is expressed by three digit numbers.

The first two digits represents significant figures and the last digit denotes the number of zero

Ex.) 104 = 100000pF R denotes decimal 8R2 = 8.2pF

5 Capacitance Tolerance Code

Code	Tolerance	Code	Tolerance
B	±0.1pF	M	±20%
C	±0.25pF	P	+100, -0%
D	±0.5pF	Z	+80, -20%
F	±1.0%	H	+0.25/-0pF
G	±2.0%	I	+0/-0.25pF
J	±5%	U	+5/-0%
K	±10%	V	+0/-5%

6 Voltage Code

Code	6R3	100	160	250	500	101	201	251	631	302
Vol.	DC 6.3V	DC 10V	DC 16V	DC 25V	DC 50V	DC 100V	DC 200V	DC 250V	DC 630V	DC 3000V

7 Termination Code

Ex.) N : Ni-Sn(Nickel-Tin Plate)

8 Packing Code

Ex.) R : Reel Type B : Bulk Type

9 Thickness Option

Size(mm)	Thickness(mm)		Code	Size(mm)	Thickness(mm)		Code
	t	Tol(±)			t	Tol(±)	
0603/1005	0.3	0.03	-	3216	1.15	0.15	E
1005	0.5	0.05	-	3216/3225	1.6	0.2	I
2012	0.6	0.1	A	3225	1.8	0.2	J
1608	0.8	0.1	B	3225/4532/5750	2	0.25	K
2012/3216	0.85	0.15	B	3225/4532/5750	2.5	0.25	L
2012	1.25	0.15	E				

Size(mm)	Code	Packaging	Size(mm)	Code	Packaging
0603/1005	-	Paper Taping	3216	E	Embossed Taping
1005	-	Paper Taping	3216/3225	I	Embossed Taping
2012	A	Paper Taping	3225	J	Embossed Taping
1608	B	Paper Taping	3225/4532/5750	K	Embossed Taping
2012/3216	B	Paper Taping	3225/4532/5750	L	Embossed Taping
2012	E	Embossed Taping			

SMD Type

Typical Performance Characteristics

COG

Application

Suited for precision circuits, requiring stable dielectric characteristics, negligible dependence of capacitance and dissipation factor on time, voltage and frequency.

Dielectric Characteristics

Temperature Characteristic	$0 \pm 30 \text{ ppm}/^\circ\text{C}$
Operating Temperature	$-55 \sim 125^\circ\text{C}$
Capacitance Tolerance	$> 10 \text{ pF} : \pm 5\%, \pm 10\%, (\pm 1\%, \pm 2\%, \pm 20\%)$ $\leq 10 \text{ pF} : \pm 0.1 \text{ pF}, \pm 0.25 \text{ pF}, \pm 0.5 \text{ pF}$
Dissipation Factor & Q	$\geq 30 \text{ pF} : \text{DF} \leq 0.1\%, Q \geq 1000$ $< 30 \text{ pF} : Q \geq 400 + 20 \times C$
Insulation Resistance	More than $10,000 \text{ M}\Omega$ or $500 \text{ }\Omega\text{F}$ (Whichever is smaller)
Dielectric Strength	$> 3 \times \text{RVDC}$
Test Voltage	$0.5 \text{ to } 5 \text{ Vrms} (\leq 1000 \text{ pF}), 1 \pm 0.2 \text{ Vrms} (> 1000 \text{ pF})$
Test Frequency	$1 \pm 0.1 \text{ MHz} (\leq 1000 \text{ pF}), 1 \pm 0.1 \text{ kHz} (> 1000 \text{ pF})$

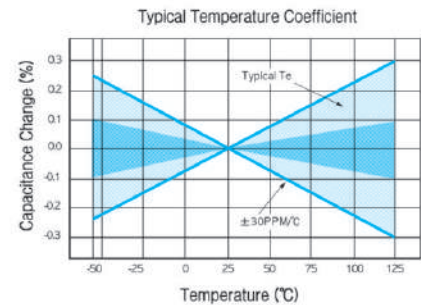

X7R

Application

Stable class II dielectric properties, suited for by-pass and coupling purposes, filtering, frequency discrimination, DC blockage, and as voltage transient suppression elements.

Dielectric Characteristics

Temperature Characteristic	$\pm 15\%$
Operating Temperature	$-55 \sim 125^\circ\text{C}$
Capacitance Tolerance	$\pm 10\%, \pm 20\%, (\pm 5\%, +80 \sim -20\%)$
Dissipation Factor & Q	$50 \text{ V Min.} : 2.5\% \text{ Max. } 25 \text{ V Min.} : 3.0\% \text{ Max.}$ $16 \text{ V Min.} : 3.5\% \text{ Max. } 10 \text{ V Min.} : 5.0\% \text{ Max.}$ $6.3 \text{ V Min.} : 5.0\% \text{ Max.}$ Thin layer large capacitors type 12.5% Max.
Insulation Resistance	More than $10,000 \text{ M}\Omega$ or $500 \text{ }\Omega\text{F}$ (Whichever is smaller) Thin layer large capacitors type $50 \text{ }\Omega\text{F}$ Min.
Dielectric Strength	$> 2.5 \times \text{RVDC}$
Test Voltage	$1 \pm 0.2 \text{ Vrms} (\leq 10 \mu\text{F})$ $0.5 \pm 0.1 \text{ Vrms} (> 10 \mu\text{F})$
Test Frequency	$1 \pm 0.1 \text{ kHz} (\leq 10 \mu\text{F})$ $120 \pm 24 \text{ Hz} (> 10 \mu\text{F})$

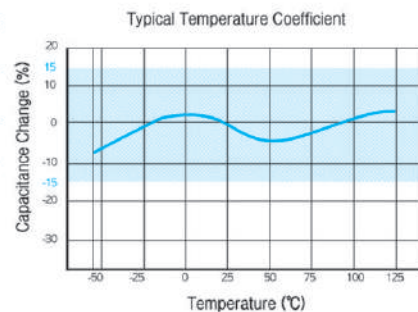

X5R

Application

Stable class II dielectric properties, suited for by-pass and coupling purposes, filtering, frequency discrimination, DC blockage, and as voltage transient suppression elements.

Dielectric Characteristics

Temperature Characteristic	±15%
Operating Temperature	-55~85°C
Capacitance Tolerance	±10%, ±20%,(±5%, +80~-20%)
Dissipation Factor & Q	50V Min. : 2.5% Max. 25V Min. : 3.0% Max. 16V Min. : 3.5% Max. 10V Min. : 5.0% Max. 6.3V Min. : 5.0% Max. Thin layer large capacitors type 12.5% Max.
Insulation Resistance	More than 10,000MΩ or 500ΩF (Whichever is smaller) Thin layer large capacitors type 50ΩF Min.
Dielectric Strength	>2.5×RVDC
Test Voltage	1±0.2Vrms(≤10μF) 0.5±0.1Vrms(>10μF)
Test Frequency	1±0.1kHz(≤10μF) 120±24Hz(>10μF)

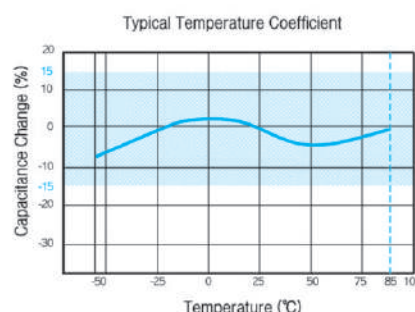

Y5V

Application

The Hi-K(Y5V) dielectrics deliver high capacitance density and are ideally suited for applications where space is at a premium, or as replacement for tantalum capacitors. Typically applications include use as by-pass or decoupling elements. Best performance is obtained at or near room temperature, with low DC bias.

Dielectric Characteristics

Temperature Characteristic	+22%~-82%
Operating Temperature	-30~85°C
Capacitance Tolerance	-20~+80%(±20%)
Dissipation Factor & Q	50V Min. : 5% Max. 25V Min. : 7% Max. 16V Min. : 9% Max. 10V Min. : 12.5% Max. 6.3V Min. : 15% Max. Thin layer large capacitors type 20% Max.
Insulation Resistance	More than 10,000MΩ or 500ΩF(Whichever is smaller) Thin layer large capacitors type 50ΩF Min.
Dielectric Strength	>2.5×RVDC
Test Voltage	1±0.2Vrms(≤10μF) 0.5±0.1Vrms(>10μF)
Test Frequency	1±0.1kHz(≤10μF) 120±24Hz(>10μF)

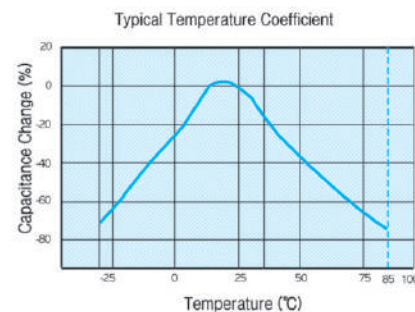

SMD Type

Appendix I

C0G-Temperature Compensating Type(0603~3216)

Type Size(inch)	C0G									
	0603(0201)		1005(0402)		1608(0603)		2012(0805)		3216(1206)	
Volt(V) Cap.	25	50	25	50	25	50	25	50	25	50
0.5pF(0R5)										
1pF(010)										
2pF(020)										
3pF(030)										
4pF(040)										
5pF(050)										
6pF(060)										
7pF(070)										
8pF(080)										
9pF(090)										
10pF(100)										
12pF(120)										
15pF(150)										
18pF(180)										
22pF(220)										
27pF(270)										
33pF(330)										
39pF(390)										
47pF(470)										
56pF(560)										
68pF(680)										
82pF(820)										
100pF(101)										
120pF(121)										
150pF(151)										
180pF(181)										
220pF(221)		0.3								
270pF(271)										
330pF(331)										
390pF(391)										
470pF(471)										
560pF(561)										
680pF(681)										
820pF(821)										
1000pF(102)	0.3									
1200pF(122)										
1500pF(152)										
1800pF(182)									1.15	1.15
2200pF(222)							0.6	0.6		
2700pF(272)										
3300pF(332)										
3900pF(392)										
4700pF(472)										
5600pF(562)										
6800pF(682)										
8200pF(822)				0.5						
10000pF(103)			0.5		0.8	0.8				
12000pF(123)										
15000pF(153)										
18000pF(183)										
22000pF(223)										
27000pF(273)										
33000pF(333)							1.25	1.25		
47000pF(473)										
56000pF(563)										
68000pF(683)										
82000pF(823)										
0.1μF(104)									1.60	1.60

Temperature Compensating Type : Dissipation Factor Page 22 (No.5)

Appendix II

X7R-High Dielectric Constant Type(0603~3225) & Thin Layer Large-Capacitance Type

Type	X7R																																								
	0603(0201)				1005(0402)					1608(0603)					2012(0805)					3216(1206)					3225(1210)																
Size(inch)																																									
Volt(V) Cap.	6.3	10	16	25	6.3	10	16	25	50	6.3	10	16	25	50	6.3	10	16	25	50	6.3	10	16	25	50	6.3	10	16	25	50	6.3	10	16	25	50							
100pF(101)																																									
470pF(471)																																									
1000pF(102)																																									
2200pF(222)																																									
4700pF(472)																																									
10000pF(103)	▼ 0.3	▼ 0.3	▼ 0.3	▼ 0.3																																					
15000pF(153)																																									
22000pF(223)																																									
33000pF(333)																																									
47000pF(473)																																									
68000pF(683)																																									
0.1μF(104)																																									
0.15μF(154)																																									
0.22μF(224)																																									
0.33μF(334)																																									
0.47μF(474)																																									
0.68μF(684)																																									
1.0μF(105)																																									
1.5μF(155)																																									
2.2μF(225)																																									
4.7μF(475)																																									
6.8μF(685)																																									
10μF(106)																																									
22μF(226)																																									
47μF(476)																																									
100μF(107)																																									

- General Type : Dissipation Factor Page 22(No.5)
- * General Type : Dissipation Factor Page 22(No.5)
- Thin Layer Large-Capacitance Type : Dissipation Factor Page 22(No.5)

SMD Type

X5R-High Dielectric Constant Type(0603~3225) & Thin Layer Large-Capacitance Type

Type	X5R																																	
	0603(0201)				1005(0402)					1608(0603)					2012(0805)					3216(1206)					3225(1210)									
Volt(V)	6.3	10	16	25	6.3	10	16	25	50	6.3	10	16	25	50	6.3	10	16	25	50	6.3	10	16	25	50	6.3	10	16	25	50					
Cap.	6.3	10	16	25	6.3	10	16	25	50	6.3	10	16	25	50	6.3	10	16	25	50	6.3	10	16	25	50	6.3	10	16	25	50	6.3	10	16	25	50
100pF(101)																																		
470pF(471)																																		
1000pF(102)																																		
2200pF(222)																																		
4700pF(472)																																		
10000pF(103)																																		
15000pF(153)																																		
22000pF(223)																																		
33000pF(333)																																		
47000pF(473)																																		
68000pF(683)																																		
0.1μF(104)																																		
0.15μF(154)																																		
0.22μF(224)																																		
0.33μF(334)																																		
0.47μF(474)																																		
0.68μF(684)																																		
1.0μF(105)																																		
1.5μF(155)																																		
2.2μF(225)																																		
4.7μF(475)																																		
6.8μF(685)																																		
10μF(106)																																		
22μF(226)																																		
47μF(476)																																		
100μF(107)																																		

- General Type : Dissipation Factor Page 22(No.5)
- * General Type : Dissipation Factor Page 22(No.5)
- Thin Layer Large-Capacitance Type : Dissipation Factor Page 22(No.5)

Y5V-High Dielectric Constant Type(0603~3225) & Thin Layer Large-Capacitance Type

Type	Y5V																																			
	1005(0402)					1608(0603)					2012(0805)					3216(1206)					3225(1210)															
	Size(inch)		Volt(V)			Cap.		6.3		10		16		25		50		6.3		10		16		25		50		6.3		10		16		25		50
1000pF(102)																																				
2200pF(222)																																				
4700pF(472)																																				
10000pF(103)																																				
15000pF(153)																																				
22000pF(223)																																				
33000pF(333)																																				
47000pF(473)																																				
68000pF(683)																																				
0.1μF(104)																																				
0.15μF(154)																																				
0.22μF(224)																																				
0.33μF(334)																																				
0.47μF(474)																																				
0.68μF(684)																																				
1.0μF(105)																																				
1.5μF(155)																																				
2.2μF(225)																																				
3.3μF(335)																																				
4.7μF(475)																																				
6.8μF(685)																																				
10μF(106)																																				
22μF(226)																																				
47μF(476)																																				
100μF(107)																																				

- General Type : Dissipation Factor Page 22(No.5)
- * General Type : Dissipation Factor Page 22(No.5)
- Thin Layer Large-Capacitance Type : Dissipation Factor Page 22(No.5)

SMD Type-High Voltage

Product Offering

SAMWHA high voltage MLCC products with the temperature characteristics of C0G and X7R are designed for commercial and industrial applications. The products are applied to DC-DC converters and ballast circuit to reduce ripple noise and diverting potentially unsafe transients in various sizes with working voltage up to DC 7kV. These high voltage capacitors feature a special internal electrode design which has capacitor network to reduce voltage concentrations by distributing voltage throughout the entire capacitor.

Features

- High reliability
- The highest voltage rating by the special internal electrode design
- Wide voltage level : from 100V_{DC} to 7,000V_{DC}
- Surface mount suited for wave and reflow soldering
- RoHS compliant

Applications

- DC-DC Converters
- Network Equipments
- Back-Lighting Inverter
- Lighting Ballast
- Modem & Power Supply
- LAN/WLAN Interface

※ special specification like a Automobile, Medical, Military, Aviation should be discuss with our sales representatives

Special Options for the Safety

- Inset electrode margins to prevent short mode failure resulted from the crack by mechanical bending stress
- Soft termination is optionally available to reduce possibility for the crack of MLCCs by mechanical bending stress

How to Order (Product Identification)

CS 4532 X7R 471 K 302 N R K

1 2 3 4 5 6 7 8 9

1 Type

CS : SMD

2 Size Code

Size(mm)	1608	2012	3216	3225	4520	4532	5750	7566	9595
----------	------	------	------	------	------	------	------	------	------

3 Dielectric (Temp. Coefficient)

COG, X7R

4 Capacitance

1st two digits are value, 3rd digit denotes number of zeros;
331 = 330pF, 104 = 100000pF, 8R2 = 8.2pF

5 Tolerance

Code	Tolerance	Code	Tolerance
B	±0.1pF	C	±0.25pF
D	±0.50pF	F	±1%
G	±2%	J	±5%
K	±10%	M	±20%
Z	+80~-20%		

6 Rated Voltage Code

1st two digits are value, 3rd digit denotes number of zeros; 302 = 3,000V, 502 = 5,000V, 722 = 7,200V

7 Plating

Ni / Sn Plated

8 Packing

B : Bulk Pack R : Reel Pack C : Case Box

9 Thickness Option

Size(mm)	Thickness(mm)		Code	Size(mm)	Thickness(mm)		Code
	t	Tol(±)			t	Tol(±)	
0603/1005	0.3	0.03	-	3216	1.15	0.15	E
1005	0.5	0.05	-	3216/3225	1.6	0.2	I
2012	0.6	0.1	A	3225	1.8	0.2	J
1608	0.8	0.1	B	3225/4532/5750	2	0.25	K
2012/3216	0.85	0.15	B	3225/4532/5750	2.5	0.25	L
2012	1.25	0.15	E				

Size(mm)	Code	Packaging	Size(mm)	Code	Packaging
0603/1005	-	Paper Taping	3216	E	Embossed Taping
1005	-	Paper Taping	3216/3225	I	Embossed Taping
2012	A	Paper Taping	3225	J	Embossed Taping
1608	B	Paper Taping	3225/4532/5750	K	Embossed Taping
2012/3216	B	Paper Taping	3225/4532/5750	L	Embossed Taping
2012	E	Embossed Taping			

SMD Type-High Voltage

Shape & Dimensions

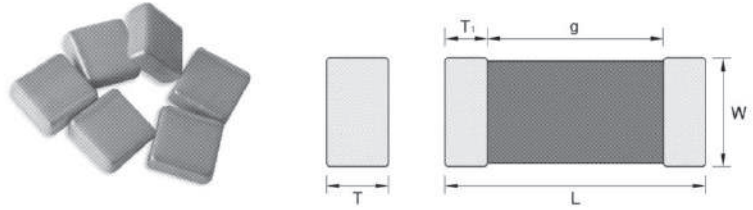

(Unit : mm)

Code	Dimensions				
	Length		Width		T1(min)
	L	Tol(±)	W	Tol(±)	
1608(0603)	1.60	0.15	0.80	0.10	0.10
2012(0805)	2.00	0.20	1.25	0.15	0.10
3216(1206)	3.20	0.30	1.60	0.20	0.15
3225(1210)	3.20	0.40	2.50	0.25	0.15
4520(1808)	4.50	0.40	2.00	0.25	0.20
4532(1812)	4.50	0.40	3.20	0.30	0.20
5750(2220)	5.70	0.50	5.00	0.40	0.30
7566(3026)	7.50	0.50	6.60	0.50	0.30
9595(3838)	9.50	0.50	9.50	0.50	0.30

*1608 Size $\geq 10\mu\text{F} \Rightarrow W : 0.8 \pm 0.15, T : 0.8 \pm 0.15$

Typical Performance Characteristics

Dielectric Characteristics

COG(NPO)

X7R

Dielectric Classification	Ultra Stable	Stable
Rated temperature range	-55°C to +125°C	-55°C to +125°C
TCC(Temperature Characteristics Coefficient)	0±30ppm	±15%
Dissipation Factor(tan δ)	C≥30pF : Q≥1,000 (DF:≤ 0.1%) C<30pF : Q≥400+20C(DF: ≤1/(400+20C))	2.5% Max.
IR(Insulation Resistance)	500V Below : Rated voltage 2Min 500V Above : 500V 2Min More than 10,000 MΩ	500V Below:Rated voltage 2Min 500V Above:500V 2Min -DC100V~1KV :C≥0.01μF:More than 100MΩμF :C<0.01μF:More than 10,000MΩ -DC2~3KV:More than6,000 MΩ
Capacitance Tolerance	<10pF : ±0.25pF, ±0.5pF ≥10pF : ±5%, ±0%	±10%, ±20%
Dielectric strength	630V:150% Rated Voltage 1kV~7.2kV:120% Rated Voltage	100V:150% Rated Voltage 630V:150% Rated Voltage 1kV~7.2kV: 120% Rated Voltage
Aging characteristics	0%	2.5% per decade hr, typical

Appendix High Voltage Type(100V~3000V)

COG-Temperature Compensation Type

High voltage type

Type	COG																															
	1608(0603)		2012(0805)		3216(1206)				3225(1210)				4520(1808)					4532(1812)					7066(3026)		9595(3838)							
Size(inch)	100	250	100	250	100	250	630	1000	2000	100	250	630	1000	2000	100	250	630	1000	2000	3000	100	250	630	1000	2000	3000	3000	4000	3000	4000	5000	7000
Volt(V) Cap.																																
4.7 pF(4R7)																																
5 pF(050)																																
7 pF(070)																																
8 pF(080)																																
9 pF(090)																																
10 pF(100)																																
12 pF(120)																																
15 pF(150)																																
18 pF(180)																																
22 pF(220)																																
47 pF(470)																																
56 pF(560)																																
68 pF(680)																																
82 pF(820)																																
100 pF(101)																																
180 pF(180)																																
220 pF(221)																																
330 pF(331)																																
470 pF(471)																																
560 pF(561)																																
680 pF(681)																																
1000 pF(102)																																
1500 pF(152)																																
2200 pF(222)																																
2700 pF(272)																																
3300 pF(332)																																
4700 pF(472)																																
5600 pF(562)																																
6800 pF(682)																																
10000 pF(103)																																
15000 pF(153)																																
22000 pF(223)																																
33000 pF(333)																																

SMD Type-High Voltage

X7R-High Dielectric Type

High voltage type

Type	X7R																									
	1608(0603)		2012(0805)		3216(1206)					3225(1210)					4520(1808)					4532(1812)						
Volt(V) Cap.	100	250	100	250	100	250	630	1000	2000	100	250	630	1000	2000	100	250	630	1000	2000	3000	100	250	630	1000	2000	3000
220 pF (221)																										
330 pF (331)																										
470 pF (471)																										
680 pF (681)																										
1000 pF (102)																										
1500 pF (152)																										
2200 pF (222)																										
3300 pF (332)																										
4700 pF (472)																										
5600 pF (562)																										
6800 pF (682)																										
10000 pF (103)																										
15000 pF (153)																										
18000 pF (183)																										
22000 pF (223)																										
33000 pF (333)																										
47000 pF (473)																										
68000 pF (683)																										
0.1 μF (104)																										
0.15 μF (154)																										
0.22 μF (224)																										
0.33 μF (334)																										
0.47 μF (474)																										
0.68 μF (684)																										
1.0 μF (105)																										
2.2 μF (225)																										

Size	Vr(V)	100pF	470pF	1.0nF	2.2nF	10nF	47nF	100nF	150nF
3026	3,000								
	4,000								
3838	3,000								
	4,000								
	5,000								
	7,000								

Application(Typical circuit)

DC-DC Converter

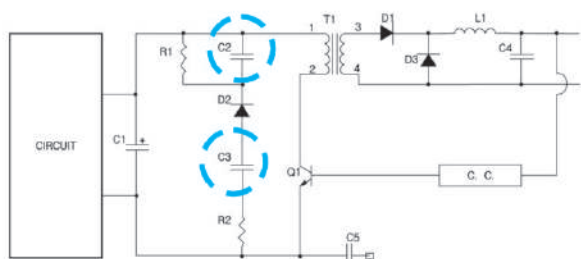

High stable operating for Tr(Q1) switching

- C2 : X7R ; 250V 10nF~47nF
- C3 : COG ; 630V 47pF~100pF

Switching Power Supply

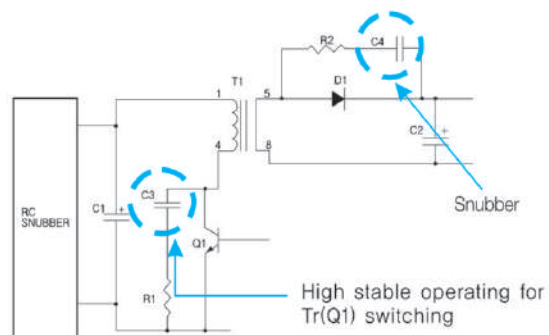

- C3 : COG, X7R ; 2kV 100pF~1000pF
- C4 : COG, X7R ; 2kV 100pF~1000pF

Primary circuit and Snubber switching power supply

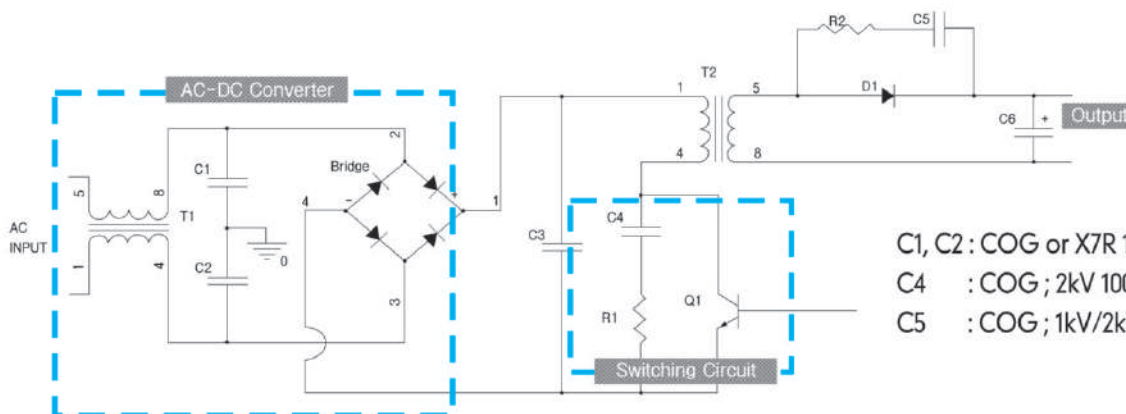

- C1, C2 : COG or X7R 1000pF~4700pF
- C4 : COG ; 2kV 100pF~330pF
- C5 : COG ; 1kV/2kV 100pF~470pF

LCD back light Inverter

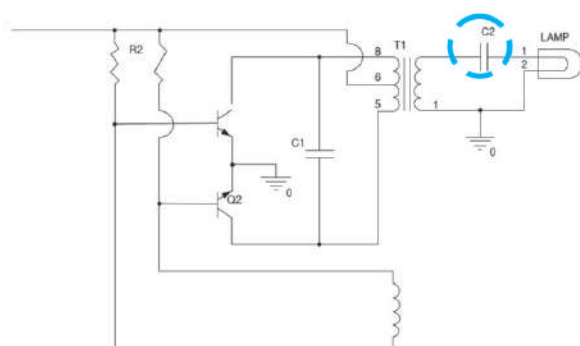

- C2 : COG ; 3kV 10~100pF

SMD Type-High Voltage

MLCC Applications for DC-DC Converter Modules

High voltage MLCCs are mainly used to DC-DC converter modules for industrial applications which have high input voltage of typical 48V. These are used as functions of high frequency noise filtering(decoupling) of power line and snubber capacitor to protect switching device from unsafe transients by inductance of transformer or connection line due to switching operation.

For these applications, MLCCs have merits for high allowable ripple current and high reliability.

Figure 2 shows isolated DC-DC converter circuit diagram and MLCC applications such as decoupling and snubber. Input voltage is 36~75V_{DC}(typical 48V_{DC}) for general industrial applications such as base station, server and network equipments. Decoupling MLCCs are applied to input and output(based on viewpoint of switch or transformer) power line to reduce ripple voltage, and MLCCs for snubber application used to absorb surge energy. SAMWHA MLCCs are recommended for each application as shown in Table 1.

Table 1. MLCC recommendation for isolated type DC-DC converter module

Items	MLCC Recommendation
*Input (C1, C2)	1210 X7R 470nF 100V 1812 X7R 1.0uF 100V
Snubber (C3~C6)	Available wide range of products 250V ~2kV (Available up to 7.2 kV) 100pF~2.2nF(Available up to 470nF)
Output (C7)	(High Capacitance Application) 1210 X5R 100uF 6.3V 1206 X5R 47uF 6.3V 0805 X5R 47uF 6.3V

*Typical input voltage of 48V for industrial application

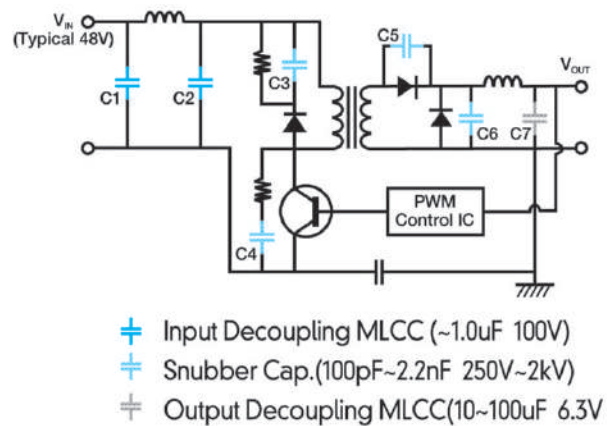

MLCC Applications for Ballast Circuits

High voltage MLCCs are suitable for the ballast circuit as a function of resonant capacitor as presented in Figure 3. MLCCs with high voltage rating from 1kV to 3kV(available up to 7.2kV) are mainly used for these application. SAMWHA offers wide range of capacitance and rated voltage with high reliability.

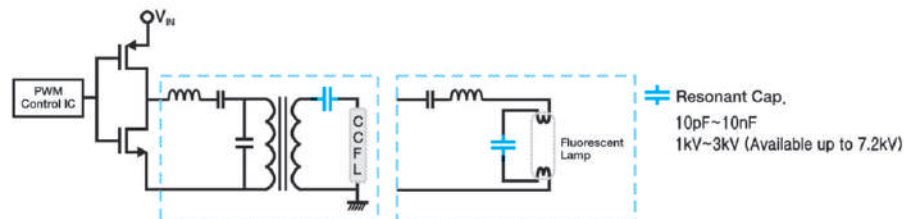

Fig. 3. Typical electronic ballast circuit and MLCC application

Caution(Rating)

1. Operating Voltage

When DC-rated capacitors are to be used in AC or ripple current circuits, be sure to maintain the V_{p-p} Value of the applied voltage or the V_{0-p} which contains DC bias within the rated voltage range.

When the voltage is applied to the circuit, starting or stopping may generate irregular voltage for a transit period because of resonance or switching. Be sure to use a capacitor with a rated voltage range that includes these irregular voltages.

Voltage	DV Voltage	DC+AC Voltage	AC Voltage	Pulse Voltage(1)	Pulse Voltage(2)
Positional Measurement					

2. Test condition for AC withstanding Voltage

(1) Test Equipment

Tests for AC withstanding voltage should be made with equipment capable of creating a wave similar to a 50/60 Hz sine wave. If the distorted sine wave or overload exceeding the specified voltage value is applied, a defect may be caused.

(2) Voltage applied method

The capacitor's leads or terminals should be firmly connected to the output of the withstanding voltage test equipment, and then the voltage should be raised from near zero to the test voltage. If the test voltage is applied directly to the capacitor without raising it from near zero, it should be applied with the ***zero cross**. At the end of the test time, the test voltage should be reduced to near zero, and then the capacitor's leads or terminals should be taken off the output of the withstanding voltage test equipment. If the test voltage is applied directly to the capacitor without raising it from near zero, surge voltage may occur and cause a defect.

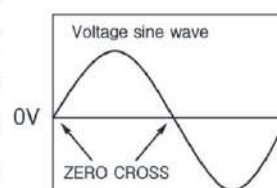

***ZERO CROSS** is the point where voltage sine wave

(3) Dielectric strength testing method

In case of dielectric strength test, the capacitor's is applied between the terminations for 1 to 5 sec., provided the charge/discharge current is less than 50mA.

3. Soldering

If a chip component is heated or cooled abruptly during soldering, it may crack due to the thermal shock. To prevent this, follow our recommendations below for adequate soldering conditions. Carefully perform preheating so that temperature difference(ΔT) between the solder and component surface is in the following range. The smaller the temperatures difference(ΔT) between the solder and component surface is, the smaller the influence on the chip is.

Soldering Method	Chip Size	
	3.2×1.6mm and under	3.2×2.5mm and over
Reflow Method or Soldering Iron Method	$\Delta T \leq 190^{\circ}\text{C}$	$\Delta T \leq 130^{\circ}\text{C}$

SMD Type-High Voltage

SAMWHA CAPACITOR CO., LTD offers a line of MLCC(Multilayer Ceramic Capacitor). These parts are rated at 3kV dc and safety approved and certified to UL (Underwriters Laboratories Inc. ®)

 **ONLINE CERTIFICATIONS DIRECTORY** [OCD Home](#) [Quick Guide](#) [Contact Us](#) [UL.com](#)

NWGQ8.E304146
Information Technology Equipment Including Electrical Business Equipment Certified for Canada - Component



[Page Bottom](#)

Information Technology Equipment Including Electrical Business Equipment Certified for Canada - Component

[See General Information for Information Technology Equipment Including Electrical Business Equipment Certified for Canada - Component](#)

SAMWHA CAPACITOR CO LTD E304146
 124 BUK-RI
 NAMSA-MYEUN
 YONGIN-SHI, KYONGGI-DO 449-880 REPUBLIC OF KOREA

Component Recognition, Model(s) CS45XXYYTTTA302NRE.

 Marking: Company name, model designation and Recognized Component Mark for Canada, .
[Last Updated](#) on 2006-04-28

[Questions?](#) [Notice of Disclaimer](#) [Page Top](#)

Copyright © 2006 Underwriters Laboratories Inc.®

The appearance of a company's name or product in this database does not in itself assure that products so identified have been manufactured under UL's Follow-Up Service. Only those products bearing the UL Mark should be considered to be Listed and covered under UL's Follow-Up Service. Always look for the Mark on the product.

UL permits the reproduction of the material contained in the Online Certification Directory subject to the following conditions: 1. The Guide Information, Designs and/or Listings (files) must be presented in their entirety and in a non-misleading manner, without any manipulation of the data (or drawings). 2. The statement "Reprinted from the Online Certifications Directory with permission from Underwriters Laboratories Inc." must appear adjacent to the extracted material. In addition, the reprinted material must include a copyright notice in the following format: "Copyright © 2006 Underwriters Laboratories Inc.®"

Reliability and Test Conditions(General Type)

No.	Item	Characteristic		Test Methods and Conditions																																													
		Temperature Compensating Type	High Dielectric Constant Type																																														
1	Operating Temperature Range	C0G : -55 to +125°C	X7R : -55 to +125°C X5R : -55 to +85°C Y5V : -30 to +85°C																																														
2	Insulation Resistance	More than 10,000MΩ or 500ΩF (Whichever is smaller)		- Applied the rated voltage for 2 minutes of charging. - The charge/discharge current is less than 50mA.																																													
3	Dielectric Strength	No defects or abnormalities		- C0G : The rated voltage × 300% - X7R, X5R, Y5V : * × 250% - Applied between the terminations for 1 to 5 seconds. - The charge/discharge current is less than 50mA.																																													
4	Capacitance	Within the specified tolerance																																															
5	Dissipation Factor	30pF Min. : Q ≥ 1,000 (DF ≤ 0.1%) 30pF Max. : Q ≥ 400+20C (DF ≤ 1/(400+20C))	<table border="1"> <thead> <tr> <th>Char.</th> <th>50V Min.</th> <th>25V</th> <th>16V</th> <th>10V</th> <th>6.3V</th> </tr> </thead> <tbody> <tr> <td>X7R</td> <td>≤ 2.5%/</td> <td>≤ 3%/</td> <td>≤ 3.5%/</td> <td>≤ 5%/</td> <td>≤ 5%/</td> </tr> <tr> <td>X5R</td> <td>* ≤ 5%</td> <td>* ≤ 7%</td> <td>* ≤ 7%</td> <td>* ≤ 10%</td> <td>* ≤ 10%</td> </tr> <tr> <td>Y5V</td> <td>≤ 5%/</td> <td>≤ 7%/</td> <td>≤ 9%</td> <td>≤ 12.5%/</td> <td>≤ 15%</td> </tr> <tr> <td></td> <td>* ≤ 9%</td> <td>* ≤ 9%</td> <td>* ≤ 12.5%</td> <td>* ≤ 15%</td> <td></td> </tr> </tbody> </table> <p>* You can check the specification at the appendix for each product with mark</p>	Char.	50V Min.	25V	16V	10V	6.3V	X7R	≤ 2.5%/	≤ 3%/	≤ 3.5%/	≤ 5%/	≤ 5%/	X5R	* ≤ 5%	* ≤ 7%	* ≤ 7%	* ≤ 10%	* ≤ 10%	Y5V	≤ 5%/	≤ 7%/	≤ 9%	≤ 12.5%/	≤ 15%		* ≤ 9%	* ≤ 9%	* ≤ 12.5%	* ≤ 15%		<p>The capacitance/Q/D.F. should be measured at 25°C at the frequency and voltage shown in the table.</p> <table border="1"> <thead> <tr> <th>Cap.</th> <th>Testing Frequency</th> <th>Testing Voltage</th> </tr> </thead> <tbody> <tr> <td>C0G (C ≤ 1000pF)</td> <td>1 ± 0.1MHz</td> <td>0.5 to 5Vrms</td> </tr> <tr> <td>C0G (C > 1000pF)</td> <td>1 ± 0.1kHz</td> <td>1 ± 0.2Vrms</td> </tr> <tr> <td>X7R, X5R, Y5V (C ≤ 10μF)</td> <td>1 ± 0.1kHz</td> <td>1 ± 0.2Vrms</td> </tr> <tr> <td>X7R, X5R, Y5V (C > 10μF)</td> <td>120 ± 24Hz</td> <td>0.5 ± 0.1Vrms</td> </tr> </tbody> </table>	Cap.	Testing Frequency	Testing Voltage	C0G (C ≤ 1000pF)	1 ± 0.1MHz	0.5 to 5Vrms	C0G (C > 1000pF)	1 ± 0.1kHz	1 ± 0.2Vrms	X7R, X5R, Y5V (C ≤ 10μF)	1 ± 0.1kHz	1 ± 0.2Vrms	X7R, X5R, Y5V (C > 10μF)	120 ± 24Hz	0.5 ± 0.1Vrms
Char.	50V Min.	25V	16V	10V	6.3V																																												
X7R	≤ 2.5%/	≤ 3%/	≤ 3.5%/	≤ 5%/	≤ 5%/																																												
X5R	* ≤ 5%	* ≤ 7%	* ≤ 7%	* ≤ 10%	* ≤ 10%																																												
Y5V	≤ 5%/	≤ 7%/	≤ 9%	≤ 12.5%/	≤ 15%																																												
	* ≤ 9%	* ≤ 9%	* ≤ 12.5%	* ≤ 15%																																													
Cap.	Testing Frequency	Testing Voltage																																															
C0G (C ≤ 1000pF)	1 ± 0.1MHz	0.5 to 5Vrms																																															
C0G (C > 1000pF)	1 ± 0.1kHz	1 ± 0.2Vrms																																															
X7R, X5R, Y5V (C ≤ 10μF)	1 ± 0.1kHz	1 ± 0.2Vrms																																															
X7R, X5R, Y5V (C > 10μF)	120 ± 24Hz	0.5 ± 0.1Vrms																																															
6	Solderability of Termination	Termination should be covered with more than 75% of new solder		- Pb-Free Type Solder : 96.5Sn-3Ag-0.5Cu Solder Temperature : 260 ± 5°C Immersion Time : 3 ± 0.1sec - Pre-Heating at 80~120°C for 10~30sec																																													
7	Resistance to Soldering Heat	Appearance	No marked defect		- Preheat the capacitor at 120 to 150°C for 1 minute. (Preheating for 3225, 4520, 4532 Step1: 100°C to 120°C, 1min Step2: 170°C to 200°C, 1min) Immerse the capacitor in a eutectic solder solution - Soldering Temp. : 260 ± 5°C - Immersion Time : 10 ± 0.5sec - Initial measurement Perform the initial measurement according to Note1 for Class II - Measurement after test Perform the final measurement according to Note2 for Class I and Class II																																												
		Capacitance change	Within ± 2.5% or ± 0.25pF (whichever is larger)	X7R, X5R : ≤ ± 7.5% Y5V : ≤ ± 20%																																													
	Dissipation Factor (or Q)	30pF Min. : Q ≥ 1,000 (DF ≤ 0.1%) 30pF Max. : Q ≥ 400+20C (DF ≤ 1/(400+20C))	<table border="1"> <thead> <tr> <th>Char.</th> <th>50V Min.</th> <th>25V</th> <th>16V</th> <th>10V</th> <th>6.3V</th> </tr> </thead> <tbody> <tr> <td>X7R</td> <td>≤ 2.5%/</td> <td>≤ 3%/</td> <td>≤ 3.5%/</td> <td>≤ 5%/</td> <td>≤ 5%/</td> </tr> <tr> <td>X5R</td> <td>* ≤ 5%</td> <td>* ≤ 7%</td> <td>* ≤ 7%</td> <td>* ≤ 10%</td> <td>* ≤ 10%</td> </tr> <tr> <td>Y5V</td> <td>≤ 5%/</td> <td>≤ 7%/</td> <td>≤ 9%</td> <td>≤ 12.5%/</td> <td>≤ 15%</td> </tr> <tr> <td></td> <td>* ≤ 9%</td> <td>* ≤ 9%</td> <td>* ≤ 12.5%</td> <td>* ≤ 15%</td> <td></td> </tr> </tbody> </table>	Char.		50V Min.	25V	16V	10V	6.3V	X7R	≤ 2.5%/	≤ 3%/	≤ 3.5%/	≤ 5%/	≤ 5%/	X5R	* ≤ 5%	* ≤ 7%	* ≤ 7%	* ≤ 10%	* ≤ 10%	Y5V	≤ 5%/	≤ 7%/	≤ 9%	≤ 12.5%/	≤ 15%		* ≤ 9%	* ≤ 9%	* ≤ 12.5%	* ≤ 15%																
Char.	50V Min.	25V	16V	10V	6.3V																																												
X7R	≤ 2.5%/	≤ 3%/	≤ 3.5%/	≤ 5%/	≤ 5%/																																												
X5R	* ≤ 5%	* ≤ 7%	* ≤ 7%	* ≤ 10%	* ≤ 10%																																												
Y5V	≤ 5%/	≤ 7%/	≤ 9%	≤ 12.5%/	≤ 15%																																												
	* ≤ 9%	* ≤ 9%	* ≤ 12.5%	* ≤ 15%																																													
I.R.	More than 10,000MΩ or 500Ω.F (Whichever is smaller)																																																

SMD Type

No.	Item	Characteristic				Test Methods and Conditions																														
		Temperature Compensating Type	High Dielectric Constant Type																																	
8	Temperature Cycle	Appearance	No marking defects				Perform the five cycles according to the four heat treatments listed in the following table. <table border="1" style="margin-top: 10px; width: 100%; border-collapse: collapse;"> <thead> <tr> <th>Step</th> <th>1</th> <th>2</th> <th>3</th> <th>4</th> </tr> </thead> <tbody> <tr> <td>Temp. (°C)</td> <td>Min. Operating Temp. +0, -3</td> <td>Room Temp.</td> <td>Max. Operating Temp. +3, -0</td> <td>Room Temp.</td> </tr> <tr> <td>Time (Min)</td> <td>30±3</td> <td>2 to 3</td> <td>30±3</td> <td>2 to 3</td> </tr> </tbody> </table> - Initial measurement Perform the initial measurement according to Note1 for Class II - Measurement after test Perform the final measurement according to Note2 for Class I and Class II	Step	1	2	3	4	Temp. (°C)	Min. Operating Temp. +0, -3	Room Temp.	Max. Operating Temp. +3, -0	Room Temp.	Time (Min)	30±3	2 to 3	30±3	2 to 3														
		Step	1	2	3	4																														
		Temp. (°C)	Min. Operating Temp. +0, -3	Room Temp.	Max. Operating Temp. +3, -0	Room Temp.																														
	Time (Min)	30±3	2 to 3	30±3	2 to 3																															
Capacitance Change	Within ±2.5% or ±0.25pF (whichever is larger)	X7R, X5R : Within ±7.5%			Y5V : Within ±20%																															
Dissipation Factor (or Q)	30pF Min. : $Q \geq 1,000$ (DF ≤ 0.1%) 30pF Max. : $Q \geq 400 + 20C$ (DF ≤ 1/(400+20C))	<table border="1" style="width: 100%; border-collapse: collapse;"> <thead> <tr> <th>Char.</th> <th>50V Min.</th> <th>25V</th> <th>16V</th> <th>10V</th> <th>6.3V</th> </tr> </thead> <tbody> <tr> <td>X7R</td> <td>≤5%/</td> <td>≤5%/</td> <td>≤5%/</td> <td>≤7.5%/</td> <td>≤7.5%/</td> </tr> <tr> <td>X5R</td> <td>* ≤7.5%</td> <td>* ≤10%</td> <td>* ≤10%</td> <td>* ≤12.5%</td> <td>* ≤12.5%</td> </tr> <tr> <td>Y5V</td> <td>≤7.5%/</td> <td>≤10%/</td> <td>≤12.5%</td> <td>≤15%/</td> <td>≤20%</td> </tr> <tr> <td></td> <td>* ≤12.5%</td> <td>* ≤12.5%</td> <td>* ≤15%</td> <td>* ≤20%</td> <td></td> </tr> </tbody> </table>	Char.	50V Min.	25V	16V	10V	6.3V	X7R	≤5%/	≤5%/	≤5%/	≤7.5%/	≤7.5%/	X5R	* ≤7.5%	* ≤10%	* ≤10%	* ≤12.5%	* ≤12.5%	Y5V	≤7.5%/	≤10%/	≤12.5%	≤15%/	≤20%		* ≤12.5%	* ≤12.5%	* ≤15%	* ≤20%					
Char.	50V Min.	25V	16V	10V	6.3V																															
X7R	≤5%/	≤5%/	≤5%/	≤7.5%/	≤7.5%/																															
X5R	* ≤7.5%	* ≤10%	* ≤10%	* ≤12.5%	* ≤12.5%																															
Y5V	≤7.5%/	≤10%/	≤12.5%	≤15%/	≤20%																															
	* ≤12.5%	* ≤12.5%	* ≤15%	* ≤20%																																
I.R.	More than 10,000MΩ or 500Ω.F (Whichever is smaller)																																			
9	Humidity Load	Appearance	No marking defects				- Temperature : 40±2°C - Humidity : 90~95% - Hour : 500±12hrs - Test Voltage : The rated voltage - Initial measurement Perform the initial measurement according to Note1 for Class II - Measurement after test Perform the final measurement according to Note2 for Class I and Class II																													
		Capacitance Change	Within ±7.5% or ±0.75pF (whichever is larger)	X7R, X5R : Within ±12.5%				Y5V : Within +30%, -40% (Y5V/1.0μF, 2.2μF, 4.7μF/10V) Within ±30% (others)																												
		Dissipation Factor (or Q)	30pF Min. : $Q \geq 200$ (DF ≤ 0.5%) 30pF Max. : $Q \geq 100 + 10/3C$ (DF ≤ 1/(100+10/3C))	<table border="1" style="width: 100%; border-collapse: collapse;"> <thead> <tr> <th>Char.</th> <th>50V Min.</th> <th>25V</th> <th>16V</th> <th>10V</th> <th>6.3V</th> </tr> </thead> <tbody> <tr> <td>X7R</td> <td>≤5%/</td> <td>≤5%/</td> <td>≤5%/</td> <td>≤7.5%/</td> <td>≤7.5%/</td> </tr> <tr> <td>X5R</td> <td>* ≤7.5%</td> <td>* ≤10%</td> <td>* ≤10%</td> <td>* ≤12.5%</td> <td>* ≤12.5%</td> </tr> <tr> <td>Y5V</td> <td>≤7.5%/</td> <td>≤10%/</td> <td>≤12.5%</td> <td>≤15%/</td> <td>≤20%</td> </tr> <tr> <td></td> <td>* ≤12.5%</td> <td>* ≤12.5%</td> <td>* ≤15%</td> <td>* ≤20%</td> <td></td> </tr> </tbody> </table>	Char.	50V Min.		25V	16V	10V	6.3V	X7R	≤5%/	≤5%/	≤5%/	≤7.5%/	≤7.5%/	X5R	* ≤7.5%	* ≤10%	* ≤10%	* ≤12.5%	* ≤12.5%	Y5V	≤7.5%/	≤10%/	≤12.5%	≤15%/	≤20%		* ≤12.5%	* ≤12.5%	* ≤15%	* ≤20%		
	Char.	50V Min.	25V	16V	10V	6.3V																														
X7R	≤5%/	≤5%/	≤5%/	≤7.5%/	≤7.5%/																															
X5R	* ≤7.5%	* ≤10%	* ≤10%	* ≤12.5%	* ≤12.5%																															
Y5V	≤7.5%/	≤10%/	≤12.5%	≤15%/	≤20%																															
	* ≤12.5%	* ≤12.5%	* ≤15%	* ≤20%																																
I.R.	More than 500MΩ or 25Ω.F (Whichever is smaller)																																			
10	High Temperature Load	Appearance	No marking defects				- Testing time : 1000±12hrs - Applied voltage : Rated voltage < DC250V : ×200% - Temperature : C0G, X7R → 125±3°C X5R, Y5V → 85±3°C - Initial measurement Perform the initial measurement according to Note1 for Class II - Measurement after test Perform the final measurement according to Note2 for Class I and Class II																													
		Capacitance Change	Within ±3% or ±0.3pF (whichever is larger)	X7R, X5R : Within ±12.5%				Y5V : Within ±30% (Cap. < 1.0μF) Within +30%, -40% (Cap. ≥ 1.0μF)																												
		Dissipation Factor (or Q)	30pF Min. : $Q \geq 350$ (DF ≤ 0.3%) 10pF ≤ Cp ≤ 30pF : $Q \geq 275 + 5/2C$ (DF ≤ 1/(275+5/2C)) 10pF Max. : $Q \geq 200 + 10C$ (DF ≤ 1/(200+10C))	<table border="1" style="width: 100%; border-collapse: collapse;"> <thead> <tr> <th>Char.</th> <th>50V Min.</th> <th>25V</th> <th>16V</th> <th>10V</th> <th>6.3V</th> </tr> </thead> <tbody> <tr> <td>X7R</td> <td>≤5%/</td> <td>≤5%/</td> <td>≤5%/</td> <td>≤7.5%/</td> <td>≤7.5%/</td> </tr> <tr> <td>X5R</td> <td>* ≤7.5%</td> <td>* ≤10%</td> <td>* ≤10%</td> <td>* ≤12.5%</td> <td>* ≤12.5%</td> </tr> <tr> <td>Y5V</td> <td>≤7.5%/</td> <td>≤10%/</td> <td>≤12.5%</td> <td>≤15%/</td> <td>≤20%</td> </tr> <tr> <td></td> <td>* ≤12.5%</td> <td>* ≤12.5%</td> <td>* ≤15%</td> <td>* ≤20%</td> <td></td> </tr> </tbody> </table>	Char.	50V Min.		25V	16V	10V	6.3V	X7R	≤5%/	≤5%/	≤5%/	≤7.5%/	≤7.5%/	X5R	* ≤7.5%	* ≤10%	* ≤10%	* ≤12.5%	* ≤12.5%	Y5V	≤7.5%/	≤10%/	≤12.5%	≤15%/	≤20%		* ≤12.5%	* ≤12.5%	* ≤15%	* ≤20%		
	Char.	50V Min.	25V	16V	10V	6.3V																														
X7R	≤5%/	≤5%/	≤5%/	≤7.5%/	≤7.5%/																															
X5R	* ≤7.5%	* ≤10%	* ≤10%	* ≤12.5%	* ≤12.5%																															
Y5V	≤7.5%/	≤10%/	≤12.5%	≤15%/	≤20%																															
	* ≤12.5%	* ≤12.5%	* ≤15%	* ≤20%																																
I.R.	More than 1,000MΩ or 50Ω.F (Whichever & Smaller)																																			

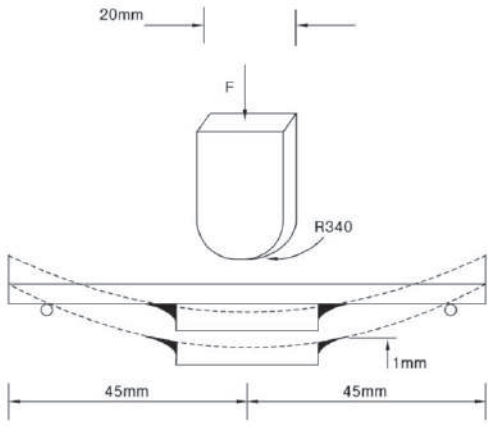
No.	Item	Characteristic		Test Methods and Conditions																									
		Temperature Compensating Type	High Dielectric Constant Type																										
11	Bending Strength	 <p>No cracking or marking defects shall occur</p>		- Substrate Material : Glass EPOXY Board - Board Thickness : 1.6mm 0.8mm(0603/1005size) ※ Test Condition - Bending Limit : 1mm - Pressurizing Speed : 1mm/sec - Holding Time: 5±1 sec																									
		Capacitance Change	Within ±5% or ±0.5pF (whichever is larger) X7R, X5R : Within ±12.5% Y5V : Within ±30%																										
12	Vibration Resistance	Appearance	No defects or abnormalities		* After soldering and then let sit for 24hr+4hr (temperature compensating type), 24hr+4hr(high dielectric constant type) at room temperature. The capacitor should be subjected to a simple harmonic motion having a total amplitude of 1.5mm, the frequency being varied uniformly between the approximate limits of 10 and 55Hz, shall be traversed(from 10Hz to 55Hz then 10Hz again) in approximately 1 minute. This motion shall be applied for a period of 2 hours in each 3 mutually perpendicular directions(total is 6hours).																								
		Capacitance	Whin the specified tolerance																										
		Q/DF	30pF Min. : Q 1,000 (DF 0.1%) 30pF Max. : Q 400+20C (DF 1/ (400+20C))	<table border="1"> <thead> <tr> <th>Char.</th> <th>50V Min.</th> <th>25V</th> <th>16V</th> <th>10V</th> <th>6.3V</th> </tr> </thead> <tbody> <tr> <td>X7R</td> <td>≤2.5%/ *≤5%</td> <td>≤3%/ *≤7%</td> <td>≤3.5%/ *≤7%</td> <td>≤5%/ *≤10%</td> <td>≤5%/ *≤10%</td> </tr> <tr> <td>X5R</td> <td>≤2.5%/ *≤5%</td> <td>≤3%/ *≤7%</td> <td>≤3.5%/ *≤7%</td> <td>≤5%/ *≤10%</td> <td>≤5%/ *≤10%</td> </tr> <tr> <td>Y5V</td> <td>≤5%/ *≤9%</td> <td>≤7%/ *≤9%</td> <td>≤9%/ *≤12.5%</td> <td>≤12.5%/ *≤15%</td> <td>≤15%</td> </tr> </tbody> </table>		Char.	50V Min.	25V	16V	10V	6.3V	X7R	≤2.5%/ *≤5%	≤3%/ *≤7%	≤3.5%/ *≤7%	≤5%/ *≤10%	≤5%/ *≤10%	X5R	≤2.5%/ *≤5%	≤3%/ *≤7%	≤3.5%/ *≤7%	≤5%/ *≤10%	≤5%/ *≤10%	Y5V	≤5%/ *≤9%	≤7%/ *≤9%	≤9%/ *≤12.5%	≤12.5%/ *≤15%	≤15%
Char.	50V Min.	25V	16V	10V	6.3V																								
X7R	≤2.5%/ *≤5%	≤3%/ *≤7%	≤3.5%/ *≤7%	≤5%/ *≤10%	≤5%/ *≤10%																								
X5R	≤2.5%/ *≤5%	≤3%/ *≤7%	≤3.5%/ *≤7%	≤5%/ *≤10%	≤5%/ *≤10%																								
Y5V	≤5%/ *≤9%	≤7%/ *≤9%	≤9%/ *≤12.5%	≤12.5%/ *≤15%	≤15%																								
13	Humidity Steady State	Appearance	No marking defects		- Temperature : 40±2°C - Humidity : 90~95% - Hour : 500±12hours - Initial measurement Perform the initial measurement according to Note1 for Class II - Measurement after test Perform the final measurement according to Note2 for Class I and Class II																								
		Capacitance Change	Within ±5% or ±0.5pF (whichever is larger)	X7R, X5R : Within ±12.5% Y5V : Within ±30%																									
		Dissipation (or Q)	30pF Min. : Q ≥350 (DF ≤0.3%) 10pF ≤ Cp ≤ 30pF : Q ≥275 +5/2C (DF ≤1/(275+5/2C)) 10pF Max. : Q ≥200+10C (DF ≤1/(200+10C))	<table border="1"> <thead> <tr> <th>Char.</th> <th>50V Min.</th> <th>25V</th> <th>16V</th> <th>10V</th> <th>6.3V</th> </tr> </thead> <tbody> <tr> <td>X7R</td> <td>≤5%/ *≤7.5%</td> <td>≤5%/ *≤10%</td> <td>≤5%/ *≤10%</td> <td>≤7.5%/ *≤12.5%</td> <td>≤7.5%/ *≤12.5%</td> </tr> <tr> <td>X5R</td> <td>≤5%/ *≤7.5%</td> <td>≤5%/ *≤10%</td> <td>≤5%/ *≤10%</td> <td>≤7.5%/ *≤12.5%</td> <td>≤7.5%/ *≤12.5%</td> </tr> <tr> <td>Y5V</td> <td>≤7.5%/ *≤12.5%</td> <td>≤10%/ *≤12.5%</td> <td>≤12.5%/ *≤15%</td> <td>≤15%/ *≤20%</td> <td>≤20%</td> </tr> </tbody> </table>		Char.	50V Min.	25V	16V	10V	6.3V	X7R	≤5%/ *≤7.5%	≤5%/ *≤10%	≤5%/ *≤10%	≤7.5%/ *≤12.5%	≤7.5%/ *≤12.5%	X5R	≤5%/ *≤7.5%	≤5%/ *≤10%	≤5%/ *≤10%	≤7.5%/ *≤12.5%	≤7.5%/ *≤12.5%	Y5V	≤7.5%/ *≤12.5%	≤10%/ *≤12.5%	≤12.5%/ *≤15%	≤15%/ *≤20%	≤20%
		Char.	50V Min.	25V		16V	10V	6.3V																					
X7R	≤5%/ *≤7.5%	≤5%/ *≤10%	≤5%/ *≤10%	≤7.5%/ *≤12.5%	≤7.5%/ *≤12.5%																								
X5R	≤5%/ *≤7.5%	≤5%/ *≤10%	≤5%/ *≤10%	≤7.5%/ *≤12.5%	≤7.5%/ *≤12.5%																								
Y5V	≤7.5%/ *≤12.5%	≤10%/ *≤12.5%	≤12.5%/ *≤15%	≤15%/ *≤20%	≤20%																								
I.R	More than 1,000MΩ or 50Ω.F (Whichever is Smaller)																												

SMD Type

No.	Item		Characteristic				Test Methods and Conditions																										
			Temperature Compensating Type		High Dielectric Constant Type																												
14	Capacitance Temperature Change Characteristics	Capacitance Change			<table border="1" style="width: 100%; border-collapse: collapse;"> <thead> <tr> <th>Char.</th> <th>Temp. Range</th> <th>Reference Temp.</th> <th>Cap. Change</th> </tr> </thead> <tbody> <tr> <td>X7R</td> <td>-55 to +125°C</td> <td rowspan="3" style="text-align: center;">25°C</td> <td>Within ±15%</td> </tr> <tr> <td>X5R</td> <td>-55 to +85°C</td> <td>Within ±15%</td> </tr> <tr> <td>Y5V</td> <td>-30 to +85°C</td> <td>Within 22% -82%</td> </tr> </tbody> </table>		Char.	Temp. Range	Reference Temp.	Cap. Change	X7R	-55 to +125°C	25°C	Within ±15%	X5R	-55 to +85°C	Within ±15%	Y5V	-30 to +85°C	Within 22% -82%	<p>(1) Temperature Compensating Type: The temperature coefficient is determined using the capacitance measured in step 3 as a reference, When cycling the temperature sequentially from step 1 through 5, (C0G: +25 to 125°C) the capacitance shall be with in the specified tolerance for the temperature coefficient. The capacitance drift is calculated by dividing the difference between the maximum measured values in the step 1, 3 and 5 by the Cap. value in step 3</p> <table border="1" style="width: 100%; border-collapse: collapse;"> <thead> <tr> <th>Step</th> <th>Temperature(°C)</th> </tr> </thead> <tbody> <tr> <td>1</td> <td>25±2</td> </tr> <tr> <td>2</td> <td>-55±3</td> </tr> <tr> <td>3</td> <td>25±2</td> </tr> <tr> <td>4</td> <td>125±3(for C0G)</td> </tr> <tr> <td>5</td> <td>25±2</td> </tr> </tbody> </table> <p>(2) High Dielectric Constant Type : The ranges of capacitance change compared with the 25°C value over the temperature range shown in the table shall be in the specified range.</p>	Step	Temperature(°C)	1	25±2	2	-55±3	3	25±2	4	125±3(for C0G)	5	25±2
		Char.	Temp. Range	Reference Temp.	Cap. Change																												
X7R	-55 to +125°C	25°C	Within ±15%																														
X5R	-55 to +85°C		Within ±15%																														
Y5V	-30 to +85°C		Within 22% -82%																														
Step	Temperature(°C)																																
1	25±2																																
2	-55±3																																
3	25±2																																
4	125±3(for C0G)																																
5	25±2																																
	Temperature Coefficient	<table border="1" style="width: 100%; border-collapse: collapse;"> <thead> <tr> <th>Char.</th> <th>Temp. Range</th> <th>Temperature Coefficient</th> </tr> </thead> <tbody> <tr> <td>C0G</td> <td>-55 to +125°C</td> <td>±30ppm/°C</td> </tr> </tbody> </table>	Char.	Temp. Range	Temperature Coefficient	C0G	-55 to +125°C	±30ppm/°C																									
Char.	Temp. Range	Temperature Coefficient																															
C0G	-55 to +125°C	±30ppm/°C																															
15	Preservation(keeping)	※ When solderability is considered, capacitors are recommended to be used in 12 months				(1) Temperature : 25°C ±10°C (2) Relative Humidity : Below 70% RH																											
16	The regulation of environmental pollution materials.	※ Never use materials mentioned below in MLCC products regulated this document. Pb, Cd, Hg, Cr ⁺⁶ , PBB(polybrominated biphenyl), PBDE(polybrominated diphenyl ethers), asbestos.																															

- In case of high Voltage and thin layer type Capacitor, it can be different from nomal specification.
So Please ask to our sales person.

- Note1. Initial Measurement for Class II

Perform a heart tertment at 150+0, -10°C for one hour and then let sit for 24±2 hours at room temperature, then measure

- Note2. Measurement after test

1. Class I

Let sit for 24±2 hours at room temperature, then measurement

2. Class II

Perform a heart treatment at 150±0, -10°C for one hour and then let sit for 24±2 hours at room temperature, then measure

SMD Type - High Frequency Capacitors

SAMWHA high frequency MLCC(CF) products offers excellent performance in demanding high RF power applications requiring consistent and reliable operation .

The copper electrodes allow for Ultra -low ESR and high Q in the GHz frequencies.

The CF series products are your best choice for high RF power applications from UHF through microwave frequencies.

Applications

- RF Power Amplifiers, Low Noise Amplifiers
- Filter Networks
- Cable TV and telecommunication networks
- GPS, Bluetooth and TV set-top boxes
- MRI Systems

Features

- Ultra Low ESR
- High Q
- High Self Resonance
- Capacitance Range : 0.5pF to 100pF
- Temperature characteristics : COG

How to Order(Product Identification)

CF 2012 COG 101 J 251 N R B

1 2 3 4 5 6 7 8 9

1 CF : High Frequency(SMD)

2 Size Code

This is expressed in tens of a millimeter.

The first two digits are the length, The last two digits are width.

SMD Type - High Frequency Capacitors

3 Temperature Coefficient Code

Classification	Code	Temperature Range	Temperature Coefficient
Class I	C0G	-55 to +125°C	±30 ppm/°C

4 Capacitance Code(Pico farads)

The nominal capacitance value in pF is expressed by three digit numbers.

The first two digits represents significant figures and the last digit denotes the number of zero

Ex.) 104 = 100000pF R denotes decimal 8R2 = 8.2pF

5 Capacitance Tolerance Code

Code	Tolerance	Code	Tolerance
B	±0.1pF	G	±2.0%
C	±0.25pF	J	±5%
D	±0.5pF	K	±10%
F	±1.0%	M	±20%

6 Voltage Code

Code	250	500	101	201	251
Rated Voltage	DC 25V	DC 50V	DC 100V	DC 200V	DC 250V

7 Termination Code

N : Nickel-Tin Plate

8 Packing Code

R : Reel Type, B : Bulk Type

9 Thickness Option

Size(mm)	Thickness(mm)		Code	Size(mm)	Thickness(mm)		Code
	t	Tol(±)			t	Tol(±)	
0603/1005	0.3	0.03	-	3216	1.15	0.15	E
1005	0.5	0.05	-	3216/3225	1.6	0.2	I
2012	0.6	0.1	A	3225	1.8	0.2	J
1608	0.8	0.1	B	3225/4532/5750	2	0.25	K
2012/3216	0.85	0.15	B	3225/4532/5750	2.5	0.25	L
2012	1.25	0.15	E				

Size(mm)	Code	Packaging	Size(mm)	Code	Packaging
0603/1005	-	Paper Taping	3216	E	Embossed Taping
1005	-	Paper Taping	3216/3225	I	Embossed Taping
2012	A	Paper Taping	3225	J	Embossed Taping
1608	B	Paper Taping	3225/4532/5750	K	Embossed Taping
2012/3216	B	Paper Taping	3225/4532/5750	L	Embossed Taping
2012	E	Embossed Taping			

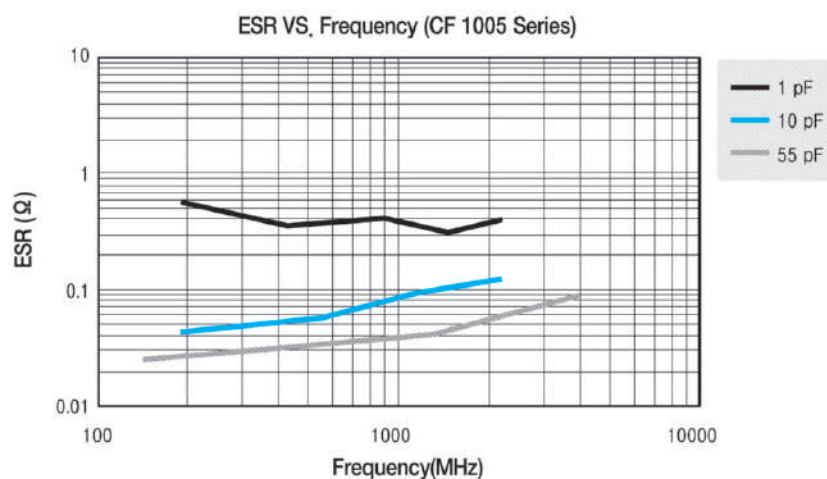
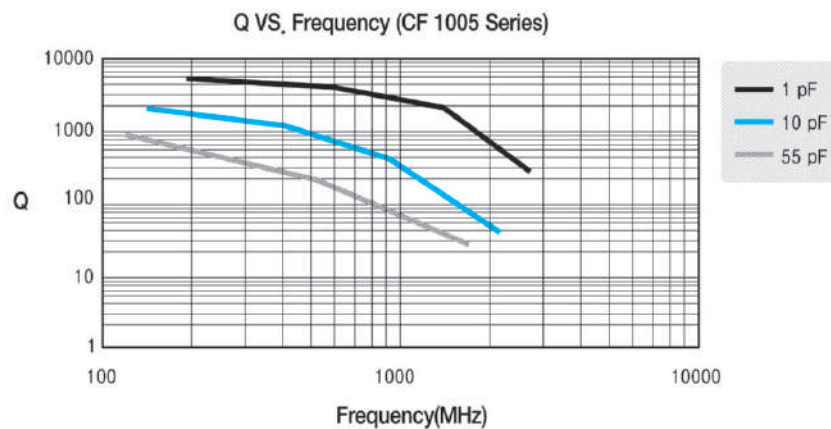

Appendix I

COG-Temperature Compensating Type(0603~2012)

Type Size(inch) Volt(V) Cap.	COG					
	1005(0402)		1608(0603)		2012(0805)	
	25	50	50	100	50	100
0.5pF(0R5)						
1pF(010)						
2pF(020)						
3pF(030)						
4pF(040)						
5pF(050)						
6pF(060)						
7pF(070)						
8pF(080)						
9pF(090)						
10pF(100)						
12pF(120)						
15pF(150)						
18pF(180)						
22pF(220)						
27pF(270)						
33pF(330)						
39pF(390)						
47pF(470)						
56pF(560)						
68pF(680)						
82pF(820)						
100pF(101)						

Automotive Applications

Features

- SAMWHA Series meet AEC-Q200 requirements
- SAMWHA Series Certify IATF 16949(ISO/TS 16949), ISO 9001, ISO 14001
- SAMWHA Series are RoHS Compliant

Applications

- Automotive electronic equipment

How to Order(Product Identification)

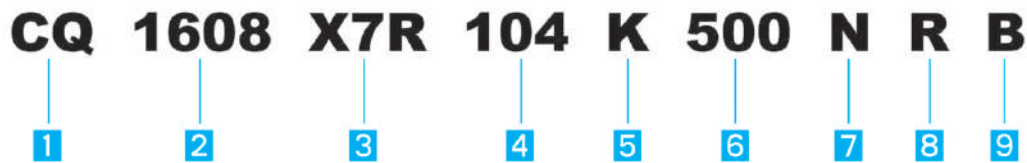

1 Monolithic Multilayer Ceramic Capacitor Leadless Type for Automotive Application

2 Size Code

This is expressed in tens of a millimeter.
The first two digits are the length, The last two digits are width.

3 Temperature Coefficient Code

Classification	Code	Temperature Range	Capacitance Change or Temperature Coefficient
Class I	C0G	-55 to +125°C	±30 ppm/°C
Class II	X7R	-55 to +125°C	±15%
Class II	X8R	-55 to +150°C	±15%

4 Capacitance Code(Pico farads)

The nominal capacitance value in pF is expressed by three digit numbers.
The first two digits represents significant figures and the last digit denotes the number of zero
Ex.) 104 = 100000pF

R denotes decimal

8R2 = 8.2pF

5 Capacitance Tolerance Code

Code	Tolerance	Code	Tolerance
B	±0.1pF	G	±2.0%
C	±0.25pF	J	±5%
D	±0.5pF	K	±10%
F	±1.0%	M	±20%

6 Voltage Code

Code	6R3	100	160	250	500	101	201	251	501	631	102	202	302
Rated Voltage	DC 6.3V	DC 10V	DC 16V	DC 25V	DC 50V	DC 100V	DC 200V	DC 250V	DC 500V	DC 630V	DC 1KV	DC 2KV	DC 3KV

7 Termination & Design Code

N : Nickel-Tin Plate A : Nickel-Tin Plate(Soft Termination) O : Open Mode F : Floating electrode
 S : Ag/Ni-SN(Ag Epoxy/Nickel-Tin Plate)+Open mode type

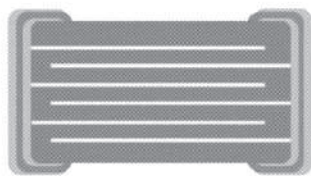

Normal Type

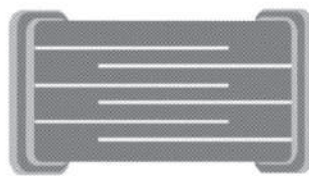

Open Mode Type

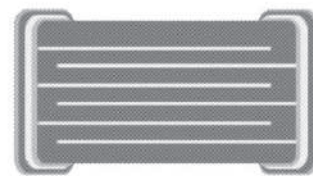

Soft Termination Type

8 Packing Code

R : Reel Type, B : Bulk Type

9 Thickness Option

Size(mm)	Thickness(mm)		Code	Size(mm)	Thickness(mm)		Code
	t	Tol(±)			t	Tol(±)	
0603/1005	0.3	0.03	-	3216	1.15	0.15	E
1005	0.5	0.05	-	3216/3225	1.6	0.2	I
2012	0.6	0.1	A	3225	1.8	0.2	J
1608	0.8	0.1	B	3225/4532/5750	2	0.25	K
2012/3216	0.85	0.15	B	3225/4532/5750	2.5	0.25	L
2012	1.25	0.15	E				

Size(mm)	Code	Packaging	Size(mm)	Code	Packaging
0603/1005	-	Paper Taping	3216	E	Embossed Taping
1005	-	Paper Taping	3216/3225	I	Embossed Taping
2012	A	Paper Taping	3225	J	Embossed Taping
1608	B	Paper Taping	3225/4532/5750	K	Embossed Taping
2012/3216	B	Paper Taping	3225/4532/5750	L	Embossed Taping
2012	E	Embossed Taping			

Temperature Characteristics See Page 39 (No.21)

Automotive Applications

Dimensions

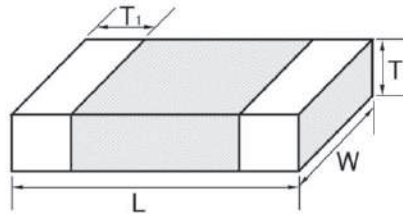

Code	Dimensions				T1(min)
	Length		Width		
	L	Tol(±)	W	Tol(±)	
1005(0402)	1.00	0.05	0.50	0.05	0.05
1608(0603)	1.60	0.15	0.80	0.10	0.10
2012(0805)	2.00	0.20	1.25	0.15	0.10
3216(1206)	3.20	0.30	1.60	0.20	0.15
3225(1210)	3.20	0.40	2.50	0.25	0.15

Construction of Termination

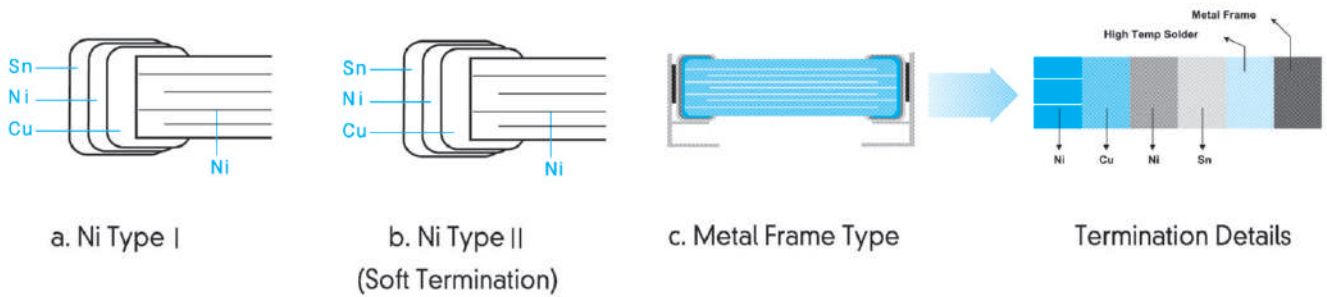

Capacitance Table.

Class I (C0G)

Size Code (EIA Code)	1005(0402)				1608(0603)				2012(0805)				3216(1206)				3225(1210)			
	Rated Volt.(V)				Rated Volt.(V)				Rated Volt.(V)				Rated Volt.(V)				Rated Volt.(V)			
Cap.	16	25	50	100	16	25	50	100	16	25	50	100	16	25	50	100	16	25	50	100
0.5pF(0R5)																				
1pF(010)																				
2.2pF(2R2)																				
3pF(030)																				
4pF(040)																				
4.7pF(4R7)																				
5pF(050)																				
6.8pF(6R8)																				
7pF(070)																				
8pF(080)																				
9pF(090)																				
10pF(100)																				
12pF(120)																				
15pF(150)																				
18pF(180)																				
22pF(220)																				
27pF(270)																				
33pF(330)																				
39pF(390)																				
47pF(470)																				
56pF(560)																				
68pF(680)																				
82pF(820)																				
100pF(101)																				
120pF(121)																				
150pF(151)																				
180pF(181)																				
220pF(221)																				
270pF(271)																				
330pF(331)																				
390pF(391)																				
470pF(471)																				
560pF(561)																				
680pF(681)																				
820pF(821)																				
1000pF(102)																				
1200pF(102)																				
1500pF(152)																				
1800pF(182)																				
2200pF(222)																				
3300pF(332)																				
4700pF(472)																				

Automotive Applications

Class II (X7R)

Size Code (EIA Code)	1005(0402)				1608(0603)				2012(0805)				3216(1206)				3225(1210)			
	16	25	50	100	16	25	50	100	16	25	50	100	16	25	50	100	16	25	50	100
Rated Volt.(V)																				
Cap.																				
1000pF(102)																				
1500pF(152)																				
2200pF(222)																				
3300pF(332)																				
4700pF(472)																				
6800pF(682)																				
10000pF(103)																				
15000pF(153)																				
22000pF(223)																				
33000pF(333)																				
47000pF(473)																				
68000pF(683)																				
0.1uF(104)																				
0.15uF(154)																				
0.22uF(224)																				
0.33uF(334)																				
0.47uF(474)																				
0.68uF(684)																				
1.0uF(105)																				
2.2uF(225)																				
4.7uF(475)																				
10uF(106)																				
22uF(226)																				

General Type for Automotive Application
 Thin Layer Large-Capacitance Type for Automotive Application

Typical Performance Characteristics

X8R

Application

The X8R series could be applicable to devices that operating in high-temperature environments
 Temperature Characteristics (x8r, -55 to 150°C, Capacitance Change $\pm 15\%$)
 Excellent DC-bias, Temperature and Aging properties

Dielectric Characteristics

Temperature Characteristic	$\pm 15\%$
Operating Temperature	-55~150°C
Capacitance Tolerance	$\pm 10\%$, $\pm 20\%$,
Dissipation Factor	50V : 2.5% max. 25V : 3.0% max. 16V : 3.5% max. 10V : 5.0% max
Insulation Resistance	More than 10,000M Ω or 50 Ω F (Whichever is smaller)
Dielectric Strength	$> 2.5 \times RVDC$
Test Voltage	0.5 ~1.0Vrms
Test Frequency	1 \pm 0.1kHz

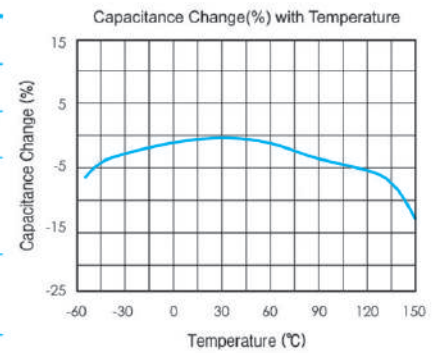

Size Code (EIA Code)	1608(0603)				2012(0805)				3216(1206)				
	16	25	50	100	16	25	50	100	16	25	50	100	
Rated Volt.(V)													
Cap.													
1000 μ F(102)													
4700 μ F(472)													
6800 μ F(682)													
10000 μ F(103)													
22000 μ F(223)													
470000 μ F(473)													
680000 μ F(683)													
0.1 μ F(104)													
0.15 μ F(154)													
0.22 μ F(224)													
0.47 μ F(474)													
0.68 μ F(684)													
1.0 μ F(105)													
2.2 μ F(225)													
4.7 μ F(475)													
10 μ F(106)													
22 μ F(226)													
47 μ F(226)													
100 μ F(226)													

Automotive Applications

Specifications and Test Methods (For Automotive Applications)

No.	AEC-Q200		Specification		Test Methods and Conditions															
			Class I	Class II																
1.	Pre-and Post-Stress Electrical Test																			
2.	High Temperature Exposure (Storage)	Appearance	No marking defects		Temperature : 150±3℃ Maintenance Time : 1000+48/-0 hrs Let sit for 24±2 hours at room temperature, then measure.															
		Capacitance Change	Within ±2.5% or ±0.25pF (Whichever is larger)	Within±10.0%																
		Q/D.F.	30pF Min.: Q≥1000 30pF Max.: Q≥400+20×C C: Nominal Capacitance(pF)	Rated Voltage 16V Min.: 0.05 Max. 10V: 0.075 Max.																
		I.R.	More than 10,000MΩ or 500Ω·F (Whichever is smaller)																	
3.	Temperature Cycle	Appearance	No marking defects		Perform the 1000 cycles according to the four heat treatments listed in the following table. Let sit for 24±2 hours at room temperature, then measure.															
		Capacitance Change	Within ±2.5% or ±0.25pF (Whichever is larger)	Within±10.0%																
		Q/D.F.	30pF Min.: Q≥1000 30pF Max.: Q≥400+20×C C: Nominal Capacitance(pF)	Rated Voltage 16V Min.: 0.05 Max. 10V: 0.075 Max.																
		I.R.	More than 10,000MΩ or 500Ω·F (Whichever is smaller)																	
					<table border="1" style="margin: auto;"> <thead> <tr> <th>Step</th> <th>1</th> <th>2</th> <th>3</th> <th>4</th> </tr> </thead> <tbody> <tr> <td>Temp.(℃)</td> <td>-55+0/-3</td> <td>25±2</td> <td>125+3/-0</td> <td>25±2</td> </tr> <tr> <td>Time(min)</td> <td>15±3</td> <td>1</td> <td>15±3</td> <td>1</td> </tr> </tbody> </table>	Step	1	2	3	4	Temp.(℃)	-55+0/-3	25±2	125+3/-0	25±2	Time(min)	15±3	1	15±3	1
Step	1	2	3	4																
Temp.(℃)	-55+0/-3	25±2	125+3/-0	25±2																
Time(min)	15±3	1	15±3	1																
					Initial measurement Perform the initial measurement according to Note 1 for Class II.															
4.	Destructive Physical Analysis		No defects or abnormalities		Per EIA-469															
5.	Moisture Resistance	Appearance	No marking defects		Temperature : 25~65℃, Humidity : 80~98% Cycle Time : 24 hrs/cycle, 10 cycles															
		Capacitance Change	Within ±3.0% or ±0.30pF (Whichever is larger)	Within±12.5%																
		Q/D.F.	30pF Min.: Q≥350 10pF Min. and 30pF Max.: Q≥275+5/2×C 10pF Max.: Q≥200+10×C C: Nominal Capacitance(pF)	Rated Voltage 16V Min.: 0.05 Max. 10V: 0.075 Max.																
		I.R.	More than 10,000MΩ or 500Ω·F (Whichever is smaller)																	
					<p style="font-size: small;">Temperature (℃) vs. Hours. One cycle 24 hours. Humidity: 90-98%.</p>															
6.	Biased Humidity	Appearance	No marking defects		Temperature : 85±3℃ Humidity : 80~85% Applied Voltage : Rated Voltage and 1.3+0.2/-0V Maintenance Time : 1000+48/-0 hrs Let sit for 24±2 hours at room temperature, then measure. The charge/discharge current is less than 50mA.															
		Capacitance Change	Within ±3.0% or ±0.30pF (Whichever is larger)	Within±12.5%																
		Q/D.F.	30pF Min.: Q≥200 30pF Max.: Q≥100+10/3×C C: Nominal Capacitance(pF)	Rated Voltage 16V Min.: 0.05 Max. 10V: 0.075 Max.																
		I.R.	More than 10,000MΩ or 500Ω·F (Whichever is smaller)																	
7.	Operational Life	Appearance	No marking defects		Temperature : 125±3℃ Applied Voltage : Rated Voltage × 200% Maintenance Time : 1000+48/-0 hrs Let sit for 24±2 hours at room temperature, then measure. The charge/discharge current is less than 50mA. Initial Measurement for Class II Applied 200% of the rated voltage for one hour at 125±3℃ Remove and let sit for 24±2 hours at room temperature, then measure.															
		Capacitance Change	Within ±3.0% or ±0.30pF (Whichever is larger)	Within±12.5%																
		Q/D.F.	30pF Min.: Q≥350 10pF Min. and 30pF Max.: Q≥275+5/2×C 10pF Max.: Q≥200+10×C C: Nominal Capacitance(pF)	Rated Voltage 16V Min.: 0.05 Max. 10V: 0.075 Max.																
		I.R.	More than 10,000MΩ or 500Ω·F (Whichever is smaller)																	

No.	AEC-Q200		Specification		Test Methods and Conditions
			Class I	Class II	
8.	External Visual		No defects or abnormalities		Visual inspection
9.	Physical Dimension		Within the specified dimensions		Using calipers
10.	Resistance to Solvents	Appearance	No marking defects		Per MIL-STD-202 Method 215
		Capacitance Change	Within the specified tolerance		
		Q/D.F.	30pF Min.: $Q \geq 1000$ 30pF Max.: $Q \geq 400 + 20 \times C$ C: Nominal Capacitance(pF)	Rated Voltage 50V: 0.025 Max. 25V: 0.03 Max. 16V: 0.035 Max. 10V: 0.05 Max.	
		I.R.	More than 10,000M Ω or 500 $\Omega \cdot F$ (Whichever is smaller)		
11.	Mechanical Shock	Appearance	No marking defects		Three shocks in each direction should be applied along 3 mutually perpendicular axes of the test specimen (18 shocks) Test Pulse Wave form : Half-sine Duration : 0.5ms Peak value : 1,500G Velocity change : 4.7m/s
		Capacitance Change	Within the specified tolerance		
		Q/D.F.	30pF Min.: $Q \geq 1000$ 30pF Max.: $Q \geq 400 + 20 \times C$ C: Nominal Capacitance(pF)	Rated Voltage 50V: 0.025 Max. 25V: 0.03 Max. 16V: 0.035 Max. 10V: 0.05 Max.	
		I.R.	More than 10,000M Ω or 500 $\Omega \cdot F$ (Whichever is smaller)		
12.	Vibration	Appearance	No defects or abnormalities		The specimens should be subjected to a simple harmonic motion having a total amplitude of 1.5mm. The entire frequency range of 10 to 2,000 Hz and return to 10 Hz should be traversed in 20 minutes. This cycle should be performed 12 times in each of three mutually perpendicular directions (total of 36 times).
		Capacitance Change	Within the specified tolerance		
		Q/D.F.	30pF Min.: $Q \geq 1000$ 30pF Max.: $Q \geq 400 + 20 \times C$ C: Nominal Capacitance(pF)	Rated Voltage 50V: 0.025 Max. 25V: 0.03 Max. 16V: 0.035 Max. 10V: 0.05 Max.	
		I.R.	More than 10,000M Ω or 500 $\Omega \cdot F$ (Whichever is smaller)		
13.	Resistance to Soldering Heat	Appearance	No marking defects		Temperature(Eutectic solder solution) : 260 \pm 5 $^{\circ}$ C Dipping Time : 10 \pm 1s Let sit for 24 \pm 2 hours at room temperature, then measure. Initial measurement Perform the initial measurement according to Note 1 for Class II.
		Capacitance Change	Within the specified tolerance		
		Q/D.F.	30pF Min.: $Q \geq 1000$ 30pF Max.: $Q \geq 400 + 20 \times C$ C: Nominal Capacitance(pF)	Rated Voltage 50V: 0.025 Max. 25V: 0.03 Max. 16V: 0.035 Max. 10V: 0.05 Max.	
		I.R.	More than 10,000M Ω or 500 $\Omega \cdot F$ (Whichever is smaller)		

Automotive Applications

No.	AEC-Q200		Specification		Test Methods and Conditions																			
			Class I	Class II																				
14.	Thermal Shock	Appearance	No marking defects		Perform the 300 cycles according to the two heat treatments listed in the following table. Transfer Time : 20s Max. Let sit for 24±2 hours at room temperature, then measure.																			
		Capacitance Change	Within ±3.0% or ±0.30pF (Whichever is larger)	Within±12.5%																				
		Q/D.F.	30pF Min.: Q≥1000 30pF Max.: Q≥400+20×C C: Nominal Capacitance(pF)	Rated Voltage 50V: 0.025 Max. 25V: 0.03 Max. 16V: 0.035 Max. 10V: 0.05 Max.																				
		I.R.	More than 10,000MΩ or 500Ω·F(Whichever is smaller)																					
				<table border="1"> <thead> <tr> <th>Step</th> <th>1</th> <th>2</th> </tr> </thead> <tbody> <tr> <td>Temp.(°C)</td> <td>-55+0/-3</td> <td>125+3/-0</td> </tr> <tr> <td>Time(min)</td> <td>15±3</td> <td>15±3</td> </tr> </tbody> </table>	Step	1	2	Temp.(°C)	-55+0/-3	125+3/-0	Time(min)	15±3	15±3											
Step	1	2																						
Temp.(°C)	-55+0/-3	125+3/-0																						
Time(min)	15±3	15±3																						
				Initial measurement Perform the initial measurement according to Note 1 for Class II.																				
15.	ESD	Appearance	No marking defects		Per AEC-Q200-002																			
		Capacitance Change	Within the specified tolerance																					
		Q/D.F.	30pF Min.: Q≥1000 30pF Max.: Q≥400+20×C C: Nominal Capacitance(pF)	Rated Voltage 50V: 0.025 Max. 25V: 0.03 Max. 16V: 0.035 Max. 10V: 0.05 Max.																				
		I.R.	More than 10,000MΩ or 500Ω·F(Whichever is smaller)																					
16.	Solderability	95% of the terminations is to be soldered evenly and continuously.		(a) Preheat at 155°C for 4 hours, and then immerse the capacitor in a solution of ethanol and rosin. Immerse in eutectic solder solution for 5+0/-0.5 seconds at 235±5°C. (b) Steam aging for 8 hours, and then immerse the capacitor in a solution of ethanol and rosin. Immerse in eutectic solder solution for 5+0/-0.5 seconds at 235±5°C. (c) Steam aging for 8 hours, and then immerse the capacitor in a solution of ethanol and rosin. Immerse in eutectic solder solution for 120±5 seconds at 260±5°C.																				
17.	Electrical Characterization	Appearance	No defects or abnormalities		The capacitance/Q/D.F. should be measured at 25°C at the frequency and voltage shown in the table																			
		Capacitance Change	Within the specified tolerance																					
		Q/D.F.	30pF Min.: Q≥1000 30pF Max.: Q≥400+20×C C: Nominal Capacitance(pF)	Rated Voltage 50V: 0.025 Max. 25V: 0.03 Max. 16V: 0.035 Max. 10V: 0.05 Max.		<table border="1"> <thead> <tr> <th>Class</th> <th>Capacitance (C)</th> <th>Frequency</th> <th>Voltage</th> </tr> </thead> <tbody> <tr> <td rowspan="2">Class I</td> <td>C≤1000pF</td> <td>1±0.1MHz</td> <td>0.5-5Vrms</td> </tr> <tr> <td>C>1000pF</td> <td>1±0.1kHz</td> <td>1±0.2Vrms</td> </tr> <tr> <td rowspan="2">Class II</td> <td>C≤110μF</td> <td>1±0.1kHz</td> <td>1±0.2Vrms</td> </tr> <tr> <td>C>10μF</td> <td>120±24Hz</td> <td>0.5±0.1Vrms</td> </tr> </tbody> </table>	Class	Capacitance (C)	Frequency	Voltage	Class I	C≤1000pF	1±0.1MHz	0.5-5Vrms	C>1000pF	1±0.1kHz	1±0.2Vrms	Class II	C≤110μF	1±0.1kHz	1±0.2Vrms	C>10μF	120±24Hz	0.5±0.1Vrms
		Class	Capacitance (C)	Frequency		Voltage																		
		Class I	C≤1000pF	1±0.1MHz		0.5-5Vrms																		
C>1000pF	1±0.1kHz		1±0.2Vrms																					
Class II	C≤110μF	1±0.1kHz	1±0.2Vrms																					
	C>10μF	120±24Hz	0.5±0.1Vrms																					
I.R. at 25°C	More than 100,000MΩ or 1,000Ω·F (Whichever is smaller)	More than 100,000MΩ or 500Ω·F (Whichever is smaller)	Should be measured with a DC voltage not exceeding rated voltage at 25°C and 125°C for 2 minutes of charging.																					
I.R. at 125°C	More than 10,000MΩ or 100Ω·F (Whichever is smaller)	More than 10,000MΩ or 10Ω·F (Whichever is smaller)																						

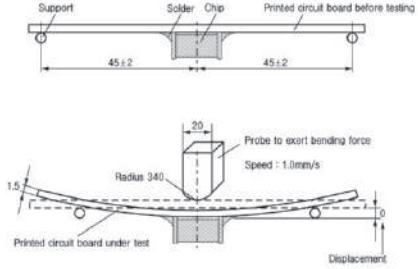
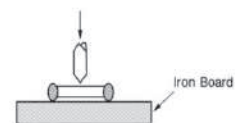
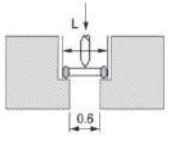
No.	AEC-Q200		Specification		Test Methods and Conditions													
			Class I	Class II														
17.		Dielectric Strength	No dielectric breakdown or mechanical breakdown		Applied 250% of the rated voltage for 1-5 seconds The charge/discharge current is less than 50mA.													
18.	Board Flex	Appearance	No marking defects		Apply a force in the direction shown in the following figure for 5±1 seconds. 													
		Capacitance Change	Within ±5.0% or ±0.5pF (Whichever is larger)	Within ±10.0%														
19.	Terminal Strength	Appearance	No marking defects		Apply *18N force in parallel with the test jig for 60±1 seconds. *10N for 1608(EIA:0603) size 2N for 1005(EIA:0402) size													
		Capacitance Change	Within ±5.0% or ±0.5pF (Whichever is larger)	Within ±10.0%														
20.	Beam Load Test		The chip endure following force.		Apply a force as shown in the following figure. (i) Chip Length : 2.5mm Max. Beam Speed : 0.5mm/s  (ii) Chip Length : 3.2mm Min. Beam Speed : 2.5mm/s 													
			<table border="1"> <thead> <tr> <th>Chip Length</th> <th>Thickness (T)</th> <th>Force</th> </tr> </thead> <tbody> <tr> <td rowspan="2">2.5mm Max.</td> <td>T ≤ 0.5mm</td> <td>8N</td> </tr> <tr> <td>T > 0.5mm</td> <td>20N</td> </tr> <tr> <td rowspan="2">3.2mm Min.</td> <td>T < 1.25mm</td> <td>15N</td> </tr> <tr> <td>T ≥ 1.25</td> <td>54.5N</td> </tr> </tbody> </table>	Chip Length	Thickness (T)	Force	2.5mm Max.	T ≤ 0.5mm	8N	T > 0.5mm	20N	3.2mm Min.	T < 1.25mm	15N	T ≥ 1.25	54.5N		
Chip Length	Thickness (T)	Force																
2.5mm Max.	T ≤ 0.5mm	8N																
	T > 0.5mm	20N																
3.2mm Min.	T < 1.25mm	15N																
	T ≥ 1.25	54.5N																

Automotive Applications

No.	AEC-Q200		Specification		Test Methods and Conditions
			Class I	Class II	
21.	Capacitance Temperature Characteristics	Capacitance Change		Within ±15%	(i) Class I The temperature coefficient is determined using the capacitance measured in step 3 as a reference. When cycling the temperature sequentially from step 1 through 5, the capacitance should be within the specified tolerance for the temperature coefficient. The capacitance drift is calculated by dividing the differences between the maximum and minimum measured values in steps 1, 3 and 5 by the capacitance value in step 3.
		Temperature Coefficient	0 ± 30 ppm/°C		
		Capacitance Drift	Within ±0.2% or ±0.05pF (Whichever is larger)		

Step	1	2	3	4	5
Temp.(°C)	25 ± 2	-55 ± 3	25 ± 2	125 ± 3	25 ± 2

(ii) Class II The ranges of capacitance change compared with the 25°C value over the temperature range from -55°C to 125°C Initial measurement Perform the initial measurement according to Note 1 for Class II.					
---	--	--	--	--	--

*Note 1. Initial Measurement for Class II

Perform a heat treatment at 150+0/-10°C for one hour, and then let sit for 24 ± 2 hours at room temperature, then measure.

Packing

Bulk packing

- ① 1000 pcs per Polybag
- ② 5 Polybags per Inner box
- ③ 10 Inner boxes per Out box

Reel Packing

- ① 8~10 Reels per Inner box
- ② 10 Inner boxes per Out box

Reel Dimensions

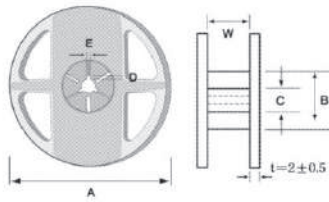

Mark	Size Code	EIA Code	A	B	C	D	E	W
7" REEL	1005~3225	0402~1210	∅178±2	∅50Min.	∅13±0.5	∅21±0.8	2±0.5	10±1.5
13" REEL	1005~3225	0402~1210	∅330±2	∅70Min.	∅13±0.5	∅21±0.8	2±0.5	10±1.5

Number of Packages

Type	EIA CODE	7" Quantity(EA)/Reel	13" Quantity(EA)/Reel
1005	0402	10,000	50,000
1608	0603	4,000	16,000
2012	0805	3,000 ~ 4,000	10,000
3216	1206	2,000 ~ 4,000	6,000 ~ 10,000
3225	1210	1,000 ~ 3,000	4,000 ~ 10,000

Tape Dimensions

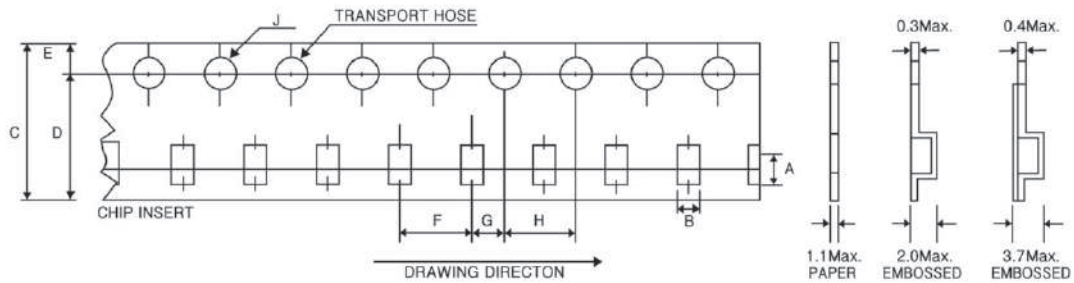

TYPE	EIA CODE	A	B	C	D	E	F	G	H	J
1005	0402	1.15±0.1	0.65±0.1	8.0±0.3	3.5±0.05	1.75±0.1	2.0±0.05	2.0±0.1	4.0±0.1	1.5±0.1
1608	0603	1.9±0.2	1.10±0.2	8.0±0.3	3.5±0.05	1.75±0.1	4.0±0.1	2.0±0.1	4.0±0.1	1.5±0.1
2012	0805	2.4±0.2	1.65±0.2	8.0±0.3	3.5±0.05	1.75±0.1	4.0±0.1	2.0±0.1	4.0±0.1	1.5±0.1
3216	1206	3.6±0.2	2.00±0.2	8.0±0.3	3.5±0.05	1.75±0.1	4.0±0.1	2.0±0.1	4.0±0.1	1.5±0.1
3225	1210	3.6±0.2	2.80±0.2	8.0±0.3	3.5±0.05	1.75±0.1	4.0±0.1	2.0±0.1	4.0±0.1	1.5±0.1

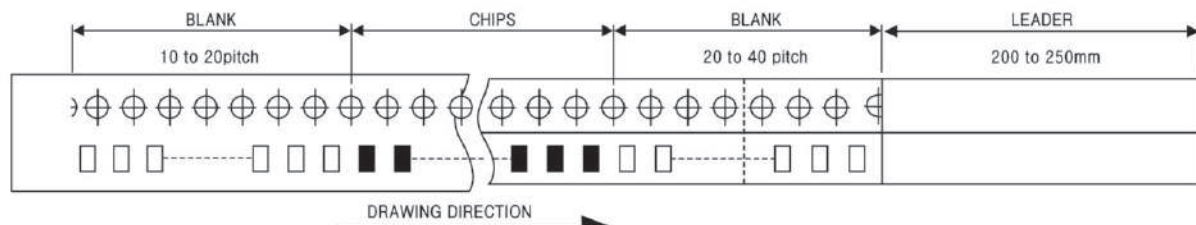

Automotive Applications

Caution

▶ Storage Condition

When solderability is considered, capacitor are recommended to be used in 12 months.

- (1) Temperature: 25°C ± 10°C
- (2) Relative Humidity: Below 70% RH

▶ The Regulation of Environmental Pollution Materials

Never use materials mentioned below in MLCC products regulated this document.

Pb, Cd, Hg, Cr⁺⁶, PBB(Polybrominated biphenyl), PBDE(Polybrominated diphenyl ethers), asbestos

▶ Mounting Position

Choose a mounting position that minimizes the stress imposed on the chip during flexing or bending of the board.

(Component direction)

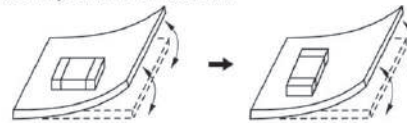

Locate chip horizontal to the direction in which stress acts

(Chip Mounting Close to Board Separation Point)

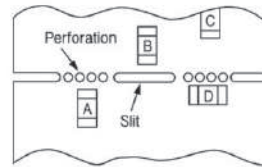

Chip arrangement Worst A-C-(B, D) Best

▶ Reflow Soldering

- The sudden temperature change easily causes mechanical damages to ceramic components. Therefore, the preheating procedures should be required for the soldering of ceramic components.
- Please refer to the recommended soldering profiles as shown in figures, and keep the temperature difference(ΔT) within the range recommended in Table 1.

Table 1.

Size code (EIA Code)	Temperature Difference
1005~3216 (0402~1206)	$\Delta T \leq 190^\circ\text{C}$
3225 (1210)	$\Delta T \leq 130^\circ\text{C}$

Infrared Reflow

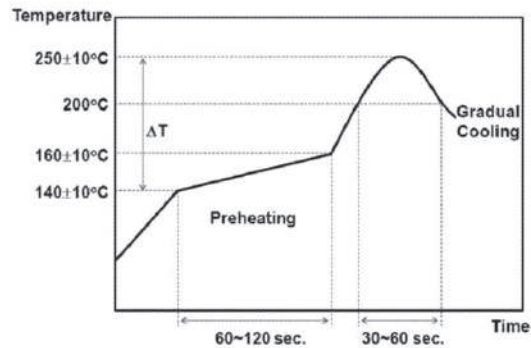

Vapor Reflow

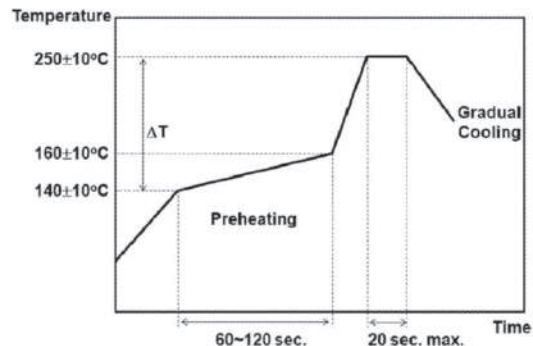

▶ 'Aging'/'De-aging' behavior of high dielectric constant type MLCCs

(Typically represented by X7R temperature characteristic of which main composition is BaTiO₃)

'Aging' / 'De-aging' Behavior of high dielectric MLCCs Please note that high dielectric type dielectric ceramic capacitors have a "normal" 'aging' behavior / characteristic, that is; their capacitance value decreases with time from its value when it was first manufactured. From that date, the capacitance value begins to decrease at a logarithmic rate defined by:

$$C_t = C_{48}(1 - k \log_{10} t)$$

- C_t : Capacitance value, t hours after the start of 'aging'
- C₄₈ : Capacitance value, 48 hours after its manufacture
- k : Aging constant (capacitance decrease per decade-hour)
- t : time, in hours, from the start of 'aging'

Ceramic's Capacitance Change(%) versus Time (hours)

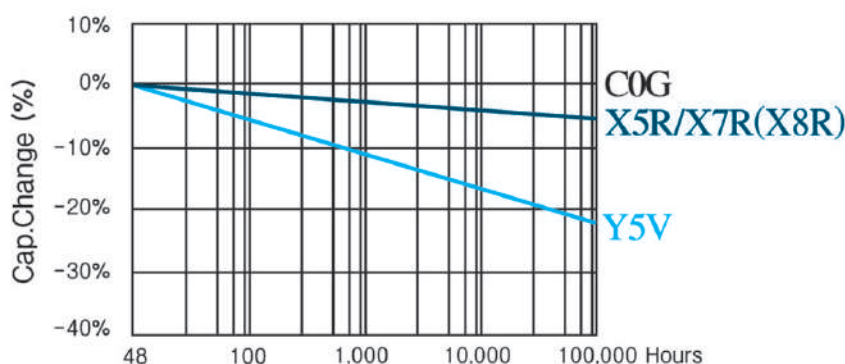

The capacitance value can be restored(also known as 'de-aged') by exposing the component to elevated temperatures approaching its curie temperature(approximately 120°C). This 'de-aging' can occur during the component's solder-assembly onto the PCB, during life or temperature cycle testing, or by baking at 150°C for about 1 hour.

Dielectric	Maximum percent capacitance loss per decade hour, k
C0G	0
X7R	~3%

X-ON Electronics

Largest Supplier of Electrical and Electronic Components

Click to view similar products for [Multilayer Ceramic Capacitors MLCC - SMD/SMT](#) category:

Click to view products by [Samwha](#) manufacturer:

Other Similar products are found below :

[M39014/02-1218V](#) [M39014/02-1225V](#) [M39014/22-0631](#) [D55342E07B523DR-T/R](#) [NCA1206X7R103K50TRPF](#) [NCA1206X7R104K16TRPF](#)
[NIN-FC2R7JTRF](#) [NMC0402NPO220J50TRPF](#) [NMC0402X5R105K6.3TRPF](#) [NMC0402X5R224K6.3TRPF](#) [NMC0402X7R103J25TRPF](#)
[NMC0402X7R392K50TRPF](#) [NMC0603NPO201J50TRPF](#) [NMC0603X7R333K16TRPF](#) [NMC0805NPO820J50TRPF](#)
[NMC0805X7R224K16TRPLPF](#) [NMC1206X7R102K50TRPF](#) [NMC1206X7R106K10TRPLPF](#) [NMC1206X7R475K10TRPLPF](#) [NMC-](#)
[Q0402NPO8R2D200TRPF](#) [C1608C0G2A221J](#) [C1608X7R1E334K](#) [C2012C0G2A472J](#) [2220J2K00562KXT](#) [CDR33BX104AKUR](#)
[CDR33BX683AKUS](#) [CGA3E1X7R1C684K](#) [CL10C0R8BB8ANNC](#) [C1005X5R0G225M](#) [C2012X7R2E223K](#) [C3216C0G2J272J](#)
[D55342E07B35E7R-T/R](#) [NMC0402X7R562J25TRPF](#) [NMC0603NPO102J25TRPF](#) [NMC1206X7R332K50TRPF](#) [726632-1](#)
[CGA6M3X7R1H225K](#) [CGA5L2X7R2A105K](#) [CGA3E2X8R1H223K](#) [CDR33BX823AKUR\M500](#) [CDR35BX474AKUR\M500](#)
[CDR35BX104BKUR\M500](#) [69995D](#) [NMC0201X5R473K6.3TRPF](#) [NMC0201X7R221K25TRPF](#) [NMC0402X5R105K10TRPF](#)
[NMC0402X5R224K10TRPF](#) [NMC0603X7R104J25TRPF](#) [NMC0603X7R223K25TRPF](#) [NMC0805NPO100J50TRPF](#)