

TO. : _____

NO. : M171222



APPROVAL SHEET

ITEM : MONOLITHIC MULTILAYER
CERAMIC CAPACITOR
(Thin Layer Large-Capacitance Type)

Approved by customer : (signing or stamping here)

SAMWHA CAPACITOR CO., LTD.		
Written by	Checked by	Approved by
		

2017. 12. 22.



SAMWHA CAPACITOR CO., LTD.

Address : 124, BUK-RI, NAMSA-MYUN YOUNGIN-SI, KYUNGKI-DO, KOREA

Contact : TEL 82-31-332-6441 , FAX 82-31-332-7661

Home page : www.samwha.com

< SPEC SUMMARY >

SAMWHA Part no.		CS1608X7R105K250NRB	
Type		Thin Layer Large-Capacitance	
Item	Specification	Unit	Test methods and Conditions(Capacitance,IR)
Capacitance	1	μF	Testing Frequency : 1 \pm 0.1kHz Testing Voltage : 1 \pm 0.2Vrms
Capacitance Tolerance	± 10	%	
Dissipation Factor	Max. 12.5	%	
Insulation Resistance	More than 50	$M\Omega$	Applied the rated voltage for 2 minutes of charging.
Chip Size	1.60 \pm 0.15	L (mm)	*Capacitance Tolerance Code --- page 1/8 *Chip size ----- page 2/8 *Characteristics & Test Method----- page 3/8~5/8
	0.80 \pm 0.10	W (mm)	
	0.80 \pm 0.10	T (mm)	

Enactment : March 27,1996	STANDARD	NO	SW - M - 04B
	MONOLITHIC MULTILAYER CERAMIC CAPACITOR LEADLESS TYPE	Page	1 / 8

1. General Article

Application Range

These specifications refer to the "Monolithic Multilayer Ceramic Capacitors Leadless Type "mainly used to the computer equipment, communication equipment.

***Caution : Industrial equipment / For the high reliability equipment / LED equipment / Etc.
Please contact sales representatives or product engineers before using the products.
(For details, please refer Page 8)**

2. General Code

(1) Type Designation

<u>CS</u>	<u>1608</u>	<u>X7R</u>	<u>105</u>	<u>K</u>	<u>250</u>	<u>N</u>	<u>R</u>	<u>B</u>
(1)	(2)	(3)	(4)	(5)	(6)	(7)	(8)	(9)

1) Monolithic Multilayer Ceramic Capacitor Leadless Type

2) Size Code :

This is expressed in tens of a millimeter.

The first two digits are the length, The last two digits are width.

3) Temperature Coefficient Code

Classification	Code	Temperature Range	Capacitance Tolerance
Class I	C0G	-55 to +125°C	±30 ppm/°C
Class II	X5R	-55 to +85°C	±15%
	X7R	-55 to +125°C	±15%
	Y5V	-30 to +85°C	+22% ~ -82%

4) Capacitance Code(Pico farads) :

The nominal Capacitance Value in pF is expressed by three digit numbers.

The first two digits represents significant figures and the last digit denotes the number of zero

ex) 104 = 100000 pF

R denotes decimal

8R2 = 8.2 pF

5) Capacitance Tolerance Code

Code	Tolerance
B	± 0.1 pF
C	± 0.25 pF
D	± 0.5 pF
F	± 1.0 %
G	± 2.0 %
J	± 5 %
K	± 10 %

Code	Tolerance
M	± 20 %
P	+ 100, - 0%
Z	+ 80, - 20%
H	+ 0.25/-0 pF
I	+ 0/-0.25 pF
U	+ 5/-0 %
V	+ 0/-5 %

6) Voltage Code

code	6R3	100	160	250	500	101	201	251	501	631	102	202	302
Vol.	DC 6.3V	DC 10V	DC 16V	DC 25V	DC 50V	DC 100V	DC 200V	DC 250V	DC 500V	DC 630V	DC 1KV	DC 2KV	DC 3KV

7) Termination Code

- ex) N : Ni-Sn (Nickel-Tin Plate)
- A : Ag/Ni-Sn (Ag Epoxy/Nickel-Tin Plate)

8) Packing Code

- ex) R : 7" Reel Type
- L : 13" Reel Type
- B : Bulk Type

9) Thickness option (Cu, Ag Epoxy)

Thickness(mm)		Code	Thickness(mm)		Code
t	Tol(±)		t	Tol(±)	
0.30	0.03	Blank	1.30	0.20	E
0.50	0.05	Blank	1.35	0.20	H
0.60	0.10	A	1.60	0.20	I
0.80	0.10	B	1.80	0.20	J
0.85	0.15	B	2.00	0.25	K
1.00	0.15	E	2.50	0.25	L
1.10	0.15	E	2.80	0.30	M
1.15	0.15	E	3.20	0.30	N
1.25	0.15	E	5.00	0.40	O

3. Temperature Characteristics

See Page 5/8 (No.13)

4. Constructions and Dimensions

(1) Dimensions

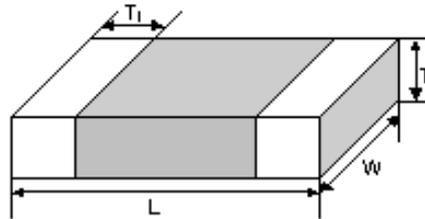

(Unit : mm)

Code	Dimension						T1(min)
	L	Length			Width		
		Cu	Ag Epoxy		Cu, Ag Epoxy	Tol(±)	
	Tol(±)	Tol(-)	Tol(+)	W	Tol(±)		
0603	0.60	0.03	-	-	0.30	0.03	0.05
1005	1.00	0.05	0.05	0.10	0.50	0.05	0.05
1608	1.60	0.15	0.15	0.20	0.80	0.10	0.10
2012	2.00	0.20	0.20	0.30	1.25	0.15	0.10
3216	3.20	0.30	0.30	0.40	1.60	0.20	0.15
3225	3.20	0.40	0.40	0.40	2.50	0.25	0.15
4520	4.50	0.40	0.40	0.40	2.00	0.25	0.20
4532	4.50	0.40	0.40	0.40	3.20	0.30	0.20
5750	5.70	0.50	0.50	0.50	5.00	0.40	0.30

*1005 Size $\geq 4.7\mu F \Rightarrow L, W, T : Tol \pm 0.15$

*1608 Size $\geq 10\mu F \Rightarrow W : 0.80 \pm 0.15, T : 0.80 \pm 0.15$

*2012 Size $\geq 10\mu F \Rightarrow W : 1.25 \pm 0.20, T : 0.85 \pm 0.15$

*3216 Size $\geq 47\mu F \Rightarrow W : 1.60 \pm 0.30, T : 1.60 \pm 0.30$

(2) Construction of Termination

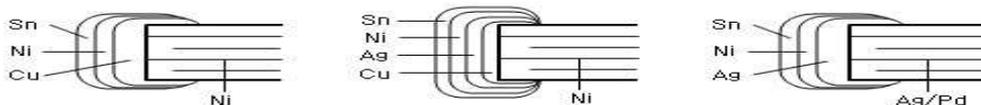

(Inner Electrode : Ni Type I) (Inner Electrode : Ni Type II) (Inner Electrode : Ag/pd Type)

Specifications and Test Methods (Thin Layer Large-Capacitance Type)

No.	Item	Specification	Test Methods and Conditions															
1	Operating Temperature Range	X7R : -55 to +125℃ X5R : -55 to +85℃ Y5V : -30 to +85℃																
2	Insulation Resistance	50Ω·F min	·Applied the rated voltage for 2 minutes of charging. The charge/discharge current is less than 50mA.															
3	Dielectric Strength	No defects or abnormalities	X7R, X5R, Y5V : The rated voltage × 250% - Applied between the terminations for 1 to 5 seconds. - The charge/discharge current is less than 50mA.															
4	Capacitance	within the specified tolerance	The capacitance/D.F. should be measured at 25℃ at the frequency and voltage shown in the table.															
5	Dissipation Factor	X7R, X5R : 12.5%max *3216 Size 100μF : 15%max Y5V : 20%max	<table border="1"> <thead> <tr> <th>Capacitance</th> <th>Frequency</th> <th>Voltage</th> </tr> </thead> <tbody> <tr> <td>C ≤ 10μF</td> <td>1 ± 0.1kHz</td> <td>0.5~1.0Vrms</td> </tr> <tr> <td>C > 10μF</td> <td>120 ± 24Hz</td> <td>0.5±0.1Vrms</td> </tr> </tbody> </table>	Capacitance	Frequency	Voltage	C ≤ 10μF	1 ± 0.1kHz	0.5~1.0Vrms	C > 10μF	120 ± 24Hz	0.5±0.1Vrms						
			Capacitance	Frequency	Voltage													
C ≤ 10μF	1 ± 0.1kHz	0.5~1.0Vrms																
C > 10μF	120 ± 24Hz	0.5±0.1Vrms																
<ul style="list-style-type: none"> Initial measurement Perform the initial measurement according to Note1 for Class II Measurement after test Take it out and set it for 24±2 hours (Class II) then measure 																		
6	Solderability of Termination	-Termination should be covered with more than 75% of new solder	*Pb-Free type Solder : 96.5Sn-3Ag-0.5Cu Solder temperature : 245±5℃ Immersion time : 3±0.1sec *Pre-Heating : at 80~120℃ for 10~30sec															
7	Resistance to Soldering Heat	Appearance	No marking defects															
		Capacitance change	X7R, X5R : Within±7.5% Y5V : Within±20%															
		Dissipation Factor	X7R, X5R : 12.5%max *3216 Size 100μF : 15%max Y5V : 20%max															
		I.R.	50Ω·F min															
			Preheat the capacitor at 120 to 150℃ for 1 minute. (Preheating for 3225,4520,4532 Step1:100℃ to 120℃, 1min Step2:170℃ to 200℃, 1min) Immerse the capacitor in a eutectic solder solution at 260±5℃ for 10±0.5 seconds.															
			·Initial measurement Perform the initial measurement according to Note1 for Class II ·Measurement after test Let sit at room temperature for 24±2 hours,then measure.															
8	Temperature Cycle	Appearance	No marking defects															
		Capacitance Change	X7R, X5R : Within ±7.5% Y5V : Within ±20%															
		Dissipation Factor	X7R, X5R : 12.5%max *3216 Size 100μF : 15%max Y5V : 20%max															
		I.R.	50Ω·F min															
			Perform the five cycles according to the four heat treatments listed in the following table.															
			<table border="1"> <thead> <tr> <th>Step</th> <th>1</th> <th>2</th> <th>3</th> <th>4</th> </tr> </thead> <tbody> <tr> <td>Temp (°C)</td> <td>Min. operating temp. +0/-3</td> <td>Room Temp</td> <td>Max. operating temp. +3/-0</td> <td>Room Temp</td> </tr> <tr> <td>Time (min)</td> <td>30±3</td> <td>2 to3</td> <td>30±3</td> <td>2 to3</td> </tr> </tbody> </table>	Step	1	2	3	4	Temp (°C)	Min. operating temp. +0/-3	Room Temp	Max. operating temp. +3/-0	Room Temp	Time (min)	30±3	2 to3	30±3	2 to3
Step	1	2	3	4														
Temp (°C)	Min. operating temp. +0/-3	Room Temp	Max. operating temp. +3/-0	Room Temp														
Time (min)	30±3	2 to3	30±3	2 to3														
			·Initial measurement Perform the initial measurement according to Note1 for Class II ·Measurement after test Perform the final measurement according to Note2															

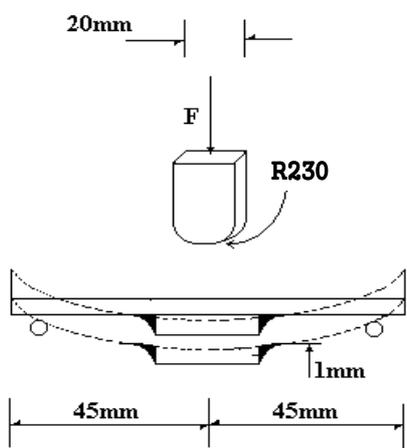
No.	Item	Specification	Test Methods and Conditions								
9	High Temperature Load	<table border="1"> <tr> <td data-bbox="295 235 454 324">Appearance</td> <td data-bbox="454 235 949 324">No marking defects</td> </tr> <tr> <td data-bbox="295 324 454 414">Capacitance Change</td> <td data-bbox="454 324 949 414">X7R, X5R : Within $\pm 12.5\%$ Y5V : Within $\pm 30\%$</td> </tr> <tr> <td data-bbox="295 414 454 526">Dissipation Factor</td> <td data-bbox="454 414 949 526">X7R, X5R : 20%max *3216 Size 100μF : 30%max Y5V : 40%max</td> </tr> <tr> <td data-bbox="295 526 454 683">I.R</td> <td data-bbox="454 526 949 683">12.5Ω·F min</td> </tr> </table>	Appearance	No marking defects	Capacitance Change	X7R, X5R : Within $\pm 12.5\%$ Y5V : Within $\pm 30\%$	Dissipation Factor	X7R, X5R : 20%max *3216 Size 100 μ F : 30%max Y5V : 40%max	I.R	12.5 Ω ·F min	<p>Apply 150% of the rated voltage for 1000+48/-0 hrs at the maximum operating temperature $\pm 3^{\circ}$C. The charge/discharge current is less than 50mA.</p> <p>-Initial measurement Perform the initial measurement according to Note1 for Class II</p> <p>-Measurement after test Perform the final measurement according to Note2</p>
Appearance	No marking defects										
Capacitance Change	X7R, X5R : Within $\pm 12.5\%$ Y5V : Within $\pm 30\%$										
Dissipation Factor	X7R, X5R : 20%max *3216 Size 100 μ F : 30%max Y5V : 40%max										
I.R	12.5 Ω ·F min										
10	Bending strength	 <p>No cracking or marking defects shall occur</p> <table border="1"> <tr> <td data-bbox="295 1220 454 1294">Capacitance Change</td> <td data-bbox="454 1220 949 1294">X7R, X5R: Within $\pm 12.5\%$ Y5V : Within $\pm 30\%$ Within +30/-40% (cap$\geq 10\mu$F)</td> </tr> </table>	Capacitance Change	X7R, X5R: Within $\pm 12.5\%$ Y5V : Within $\pm 30\%$ Within +30/-40% (cap $\geq 10\mu$ F)	<p>·Substrate material : Glass EPOXY Board.</p> <p>·Thickness : 1.6mm 0.8mm(0603/1005size)</p> <p>*. Test condition - Bending limit : 1mm - Pressurizing speed : 1mm/sec - Holding time : 5\pm1sec</p>						
Capacitance Change	X7R, X5R: Within $\pm 12.5\%$ Y5V : Within $\pm 30\%$ Within +30/-40% (cap $\geq 10\mu$ F)										
11	Vibration Resistance	<table border="1"> <tr> <td data-bbox="295 1310 454 1355">Appearance</td> <td data-bbox="454 1310 949 1355">No defects or abnormalities</td> </tr> <tr> <td data-bbox="295 1355 454 1422">Capacitance</td> <td data-bbox="454 1355 949 1422">Whin the specified tolerance</td> </tr> <tr> <td data-bbox="295 1422 454 1675">Dissipation Factor</td> <td data-bbox="454 1422 949 1675">X7R, X5R : 12.5%max *3216 Size 100μF : 15%max Y5V : 20%max</td> </tr> </table>	Appearance	No defects or abnormalities	Capacitance	Whin the specified tolerance	Dissipation Factor	X7R, X5R : 12.5%max *3216 Size 100 μ F : 15%max Y5V : 20%max	<p>*Shown in Fig. After soldering and then let sit for 24\pm2hr at room temperature. The capacitor should be subjected to a simple harmonic motion having a total amplitude of 1.5mm, the frequency being varied uniformly between the approximate limits of 10 and 55Hz, shall be traversed(from 10Hz to 55Hz then 10Hz again) in approximately 1 minute. This motion shall be applied for a period of 2 hours in each 3mutually perpendicular directions(total is 6hours).</p>		
Appearance	No defects or abnormalities										
Capacitance	Whin the specified tolerance										
Dissipation Factor	X7R, X5R : 12.5%max *3216 Size 100 μ F : 15%max Y5V : 20%max										
12	Humidity Load	<table border="1"> <tr> <td data-bbox="295 1691 454 1758">Appearance</td> <td data-bbox="454 1691 949 1758">No marking defects</td> </tr> <tr> <td data-bbox="295 1758 454 1848">Capacitance Change</td> <td data-bbox="454 1758 949 1848">X7R, X5R: Within $\pm 12.5\%$ Y5V : Within $\pm 30\%$</td> </tr> <tr> <td data-bbox="295 1848 454 1960">Dissipation Factor</td> <td data-bbox="454 1848 949 1960">X7R, X5R : 20%max *3216 Size 100μF : 30%max Y5V : 40%max</td> </tr> <tr> <td data-bbox="295 1960 454 2072">I.R.</td> <td data-bbox="454 1960 949 2072">12.5Ω·F min</td> </tr> </table>	Appearance	No marking defects	Capacitance Change	X7R, X5R: Within $\pm 12.5\%$ Y5V : Within $\pm 30\%$	Dissipation Factor	X7R, X5R : 20%max *3216 Size 100 μ F : 30%max Y5V : 40%max	I.R.	12.5 Ω ·F min	<p>Apply the rated voltage at 40\pm2$^{\circ}$C and 90 to 95%RH for 500+24/-0 hrs. The charge/discharge current is less than 50mA.</p> <p>·Initial measurement Perform the initial measurement according to Note1 for Class II</p> <p>·Measurement after test Perform the final measurement according to Note2</p>
Appearance	No marking defects										
Capacitance Change	X7R, X5R: Within $\pm 12.5\%$ Y5V : Within $\pm 30\%$										
Dissipation Factor	X7R, X5R : 20%max *3216 Size 100 μ F : 30%max Y5V : 40%max										
I.R.	12.5 Ω ·F min										

No.	Item	Specification				Test Methods and Conditions
13	Capacitance Temperature Characteristics	Char.	Temp. Range	Reference Temp.	Cap. Change	The capacitance change should be measured after 5 min. at each specified temperature stage. The ranges of capacitance change compared with the 25°C value over the temperature ranges shown in the table should be within the specified ranges.
		X5R	-55 to +85°C	25°C	Within ±15%	
		X7R	-55 to +125°C	25°C	Within ±15%	
		Y5V	-30 to +85°C	25°C	Within +22/-82%	

*Note1. Initial Measurement for Class II

Perform a heat treatment at 150+0,-10°C for one hour and then let sit for 24±2 hours at room temperature,then measure

*Note2. Measurement after test

Class II

Perform a heat treatment at 150+0,-10°C for one hour and then let sit for 24±2 hours at room temperature,then measure.

5. Packing

(1) Bulk packing

- ① 1000 pcs per Polybag
- ② 5 Polybags per Inner box
- ③ 10 Inner boxes per Out box

(2) Reel Packing

- ① 8~10 Reels per Inner box
- ② 6 Inner boxes per Out box

(3) Reel Dimensions

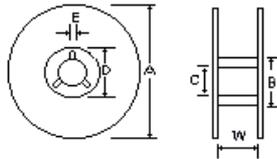

(Unit : mm)

MARK	SIZE	A	B	C	D	E	W
7 " REEL	0603~3225	$\Phi 178 \pm 2$	$\Phi 50 \text{Min}$	$\Phi 13 \pm 0.5$	$\Phi 21 \pm 0.8$	2 ± 0.5	10 ± 1.5
	4520~4532	$\Phi 180 +0, -3$	$\Phi 60 -0, +1$	$\Phi 13 \pm 0.2$	$\Phi 57 -0 +1$	3 ± 0.2	13 ± 0.5
13 " REEL	1005~3225	$\Phi 330 \pm 2$	$\Phi 70 \text{Min}$	$\Phi 13 \pm 0.5$	$\Phi 21 \pm 0.8$	2 ± 0.5	10 ± 1.5

(4) Number of Package

TYPE	EIA CODE	7"	13"
		Qt/REEL	Qt/REEL
CS0603	CC0201	15,000	
CS1005	CC0402	10,000	50,000
CS1608	CC0603	4,000	16,000
CS2012	CC0805	3,000 ~ 4,000	10,000
CS3216	CC1206	2,000 ~ 4,000	6,000 ~ 10,000
CS3225	CC1210	1,000 ~ 3,000	4,000 ~ 10,000
CS4520	CC1808	1,500 ~ 3,000	-
CS4532	CC1812	500 ~ 1,000	1,500 ~ 5,000

(5) Tape Dimensions

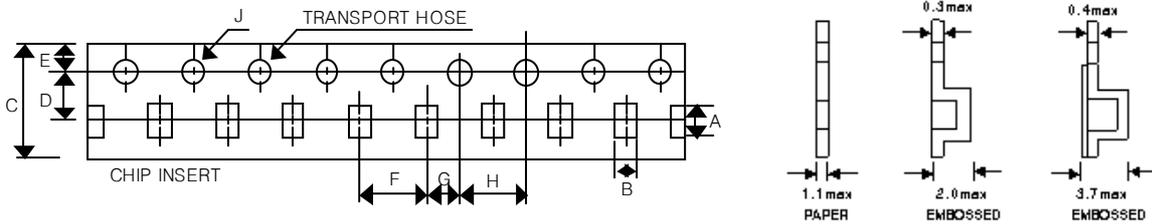

TYPE	EIA CODE	A	B	C	D	E	F	G	H	J
CS0603	CC0201	0.67 ± 0.05	0.37 ± 0.05	8.0 ± 0.3	3.5 ± 0.05	1.75 ± 0.1	2.0 ± 0.05	2.0 ± 0.1	4.0 ± 0.1	1.5 ± 0.1
CS1005	CC0402	1.15 ± 0.1	0.65 ± 0.1	8.0 ± 0.3	3.5 ± 0.05	1.75 ± 0.1	2.0 ± 0.05	2.0 ± 0.1	4.0 ± 0.1	1.5 ± 0.1
CS1608	CC0603	1.9 ± 0.2	1.10 ± 0.2	8.0 ± 0.3	3.5 ± 0.05	1.75 ± 0.1	4.0 ± 0.1	2.0 ± 0.1	4.0 ± 0.1	1.5 ± 0.1
CS2012	CC0805	2.4 ± 0.2	1.65 ± 0.2	8.0 ± 0.3	3.5 ± 0.05	1.75 ± 0.1	4.0 ± 0.1	2.0 ± 0.1	4.0 ± 0.1	1.5 ± 0.1
CS3216	CC1206	3.6 ± 0.2	2.00 ± 0.2	8.0 ± 0.3	3.5 ± 0.05	1.75 ± 0.1	4.0 ± 0.1	2.0 ± 0.1	4.0 ± 0.1	1.5 ± 0.1
CS3225	CC1210	3.6 ± 0.2	2.80 ± 0.2	8.0 ± 0.3	3.5 ± 0.05	1.75 ± 0.1	4.0 ± 0.1	2.0 ± 0.1	4.0 ± 0.1	1.5 ± 0.1
CS4520	CC1808	4.8 ± 0.2	2.3 ± 0.2	12.0 ± 0.3	5.5 ± 0.1	1.75 ± 0.1	4.0 ± 0.1 8.0 ± 0.1	2.0 ± 0.1	4.0 ± 0.1	1.5 ± 0.1
CS4532	CC1812	4.9 ± 0.2	3.6 ± 0.2	12.0 ± 0.3	5.5 ± 0.1	1.75 ± 0.1	8.0 ± 0.1	2.0 ± 0.1	4.0 ± 0.1	1.5 ± 0.1

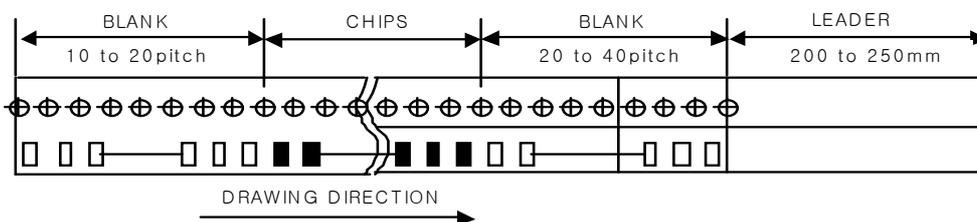

6. Caution

▶ Reflow Soldering

1. The sudden temperature change easily causes mechanical damages to ceramic components. Therefore, the preheating procedures should be required for the soldering of ceramic components.
2. Please refer to the recommended soldering profiles as shown in figures, and keep the temperature difference(ΔT) within the range recommended in Table 1.

Table 1

Size code	Temperature Difference
0603, 1005, 1608, 2012, 3216	$\Delta T \leq 190^\circ\text{C}$
3225size and over	$\Delta T \leq 130^\circ\text{C}$

[Standard Conditions for Reflow Soldering]

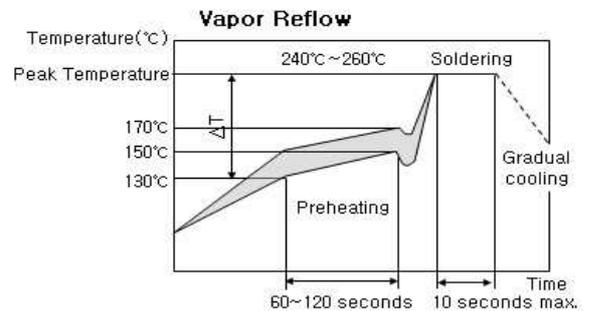
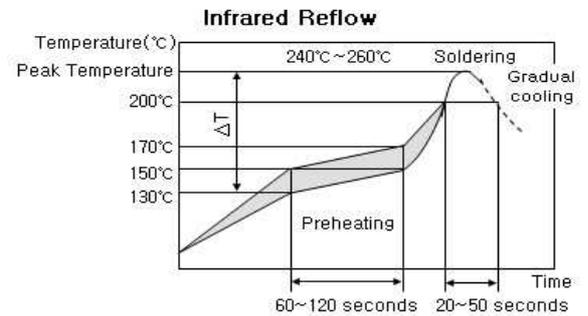

[Allowable Soldering Temperature and Time]

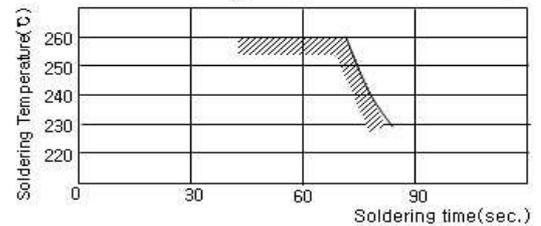

In case of repeated soldering, the accumulated soldering time must be within the range shown above.

▶ Storage Condition

*When Solderability is considered, Capacitor are recommended to be used in 12 months

- (1) Temperature: $25^\circ\text{C} \pm 10^\circ\text{C}$
- (2) Relative Humidity: Below 70% RH

▶ The Regulation of Environmental Pollution Materials.

*Never use materials mentioned below in MLCC products regulated this document.

Pb, Cd, Hg, Cr^{+6} , PBB(Polybromide biphenyl), PBDE(Polybrominated diphenyl ethers), asbestos.

X-ON Electronics

Largest Supplier of Electrical and Electronic Components

Click to view similar products for [Multilayer Ceramic Capacitors MLCC - SMD/SMT](#) category:

Click to view products by [Samwha](#) manufacturer:

Other Similar products are found below :

[M39014/02-1218V](#) [M39014/02-1225V](#) [M39014/22-0631](#) [D55342E07B523DR-T/R](#) [NIN-FB391JTRF](#) [NIN-FC2R7JTRF](#)
[NMC0402NPO220J50TRPF](#) [NMC0402X5R105K6.3TRPF](#) [NMC0402X5R224K6.3TRPF](#) [NMC0402X7R103J25TRPF](#)
[NMC0402X7R392K50TRPF](#) [NMC0603NPO101F50TRPF](#) [NMC0603NPO201J50TRPF](#) [NMC0603NPO330G50TRPF](#)
[NMC0603NPO331F50TRPF](#) [NMC0603X5R475M6.3TRPF](#) [NMC0603X7R333K16TRPF](#) [NMC0805NPO220J100TRPF](#)
[NMC0805NPO820J50TRPF](#) [NMC0805X7R224K25TRPF](#) [NMC1206X7R102K50TRPF](#) [NMC1206X7R106K10TRPLPF](#) [NMC-](#)
[H0805X7R472K250TRPF](#) [C1608C0G2A221J](#) [C1608X7R1E334K](#) [C2012C0G2A472J](#) [2220J2K00562KXT](#) [CCR06CG153FSV](#)
[CDR04BX104AKSR](#) [CDR33BX104AKUR](#) [CDR33BX683AKUS](#) [CGA3E1X7R1C684K](#) [CL10C0R8BB8ANNC](#) [M55342H06B20G0R-T/R](#)
[C1005X5R0G225M](#) [C2012X7R2E223K](#) [C3216C0G2J272J](#) [D55342E07B35E7R-T/R](#) [CDR34BX563BKUS](#) [CDR34BX563BKWS](#)
[NMC0402NPO220F50TRPF](#) [NMC0402X7R562J25TRPF](#) [NMC0603NPO102J25TRPF](#) [NMC1206X7R332K50TRPF](#) [NMC-](#)
[P1206X7R104K250TRPLPF](#) [726632-1](#) [CGA6M3X7R1H225K](#) [CGA5L2X7R2A105K](#) [CGA3E2X8R1H223K](#) [CDR33BX823AKUR\M500](#)