

Multi Layer Ceramic Capacitors

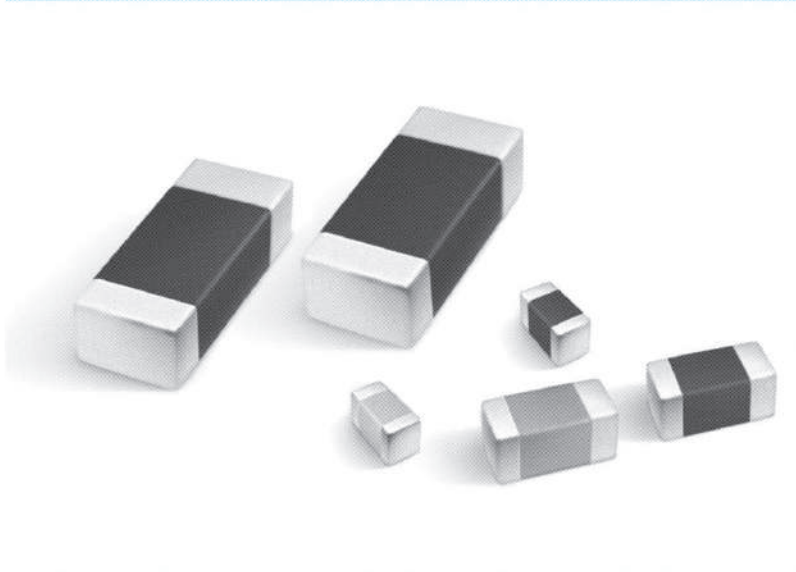

| | |
|-------------------------|----|
| SMD Type | 5 |
| SMD Type-High Voltage | 13 |
| SMD Type-High Frequency | 26 |
| Automotive Application | 29 |

Multi Layer Ceramic Capacitors

Introduction

SAMWHA's series of multilayer ceramic(MLC) chip capacitors is designed to meet a wide variety of need. Multilayer ceramic chip capacitors are available in both class I and class II formulations. Temperature compensation formulations are class I and temperature stable and general application formulations are classified at class II. The class I multilayer ceramic capacitors are COG with negligible dependence of electrical properties on temperature, voltage, frequency. The most of commonly used class II dielectric are X7R, X5R and Y5V. The X7R provides intermediate capacitance values which vary $\pm 15\%$ over the temperature range of -55°C to 125°C . The X5R provides intermediate capacitance values which vary $\pm 15\%$ over the temperature range of -55°C to 85°C . The Y5V provides the highest capacitance value which vary from 22% to -82% over the temperature range of -30°C to 85°C . All class II capacitors vary in capacitance value under the influence of temperature, operating voltage and frequency. We offer a complete line of products for both class I and II.

Features

- Samwha's high density ceramic bodies offer superior performance and reliability
- Samwha offer various temperature characteristics, rated voltage and packing method
- Material with high dielectric constant and superior manufacturing technology allows very high values in a small size
- Solder coated terminals offer superior solderability

Applications

Wide applications throughout commercial and industrial market.

- Communication products like Cellular Phone, Pager, Codeless phone
 - Multimedia products like DVD, CD-ROM, FDD, HDD, Game machine, Computer, Note book, Digital camera, LCD
 - Audio visual products like TV, Camcorder, Minidisk, MP3 Player
 - Communication products like Electronic tuner, Duplexer, VCXO, TCXO, Modem
 - OA equipment products like Printer, Copy Machine, Fax Machine
- ※ special specification like a Automobile, Medical, Military, Aviation should be discuss with our sales representatives

SMD Type

SMD Type

Shape & Dimensions

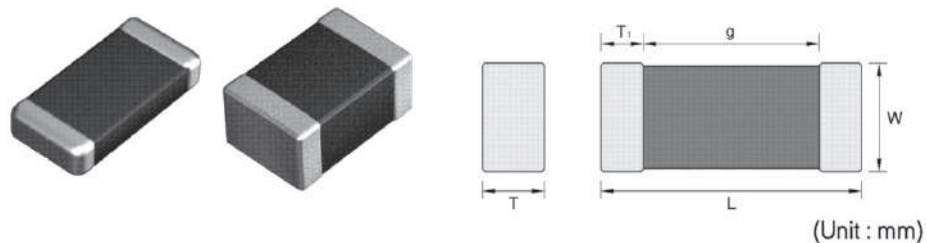

(Unit : mm)

| Code(inch) | Dimensions | | | | |
|------------|------------|--------|-------|--------|---------|
| | Length | | Width | | T1(min) |
| | L | Tol(±) | W | Tol(±) | |
| 0603(0201) | 0.60 | 0.03 | 0.30 | 0.03 | 0.05 |
| 1005(0402) | 1.00 | 0.05 | 0.50 | 0.05 | 0.05 |
| 1608(0603) | 1.60 | 0.15 | 0.80 | 0.10 | 0.10 |
| 2012(0805) | 2.00 | 0.20 | 1.25 | 0.15 | 0.10 |
| 3216(1206) | 3.20 | 0.30 | 1.60 | 0.20 | 0.15 |
| 3225(1210) | 3.20 | 0.40 | 2.50 | 0.25 | 0.15 |
| 4520(1808) | 4.50 | 0.40 | 2.00 | 0.25 | 0.20 |
| 4532(1812) | 4.50 | 0.40 | 3.20 | 0.30 | 0.20 |
| 5750(2220) | 5.70 | 0.50 | 5.00 | 0.40 | 0.30 |

*1608 Size $\geq 10\mu F \Rightarrow W : 0.8 \pm 0.15, T : 0.8 \pm 0.15$

How to Order(Product Identification)

CS 1608 X7R 104 K 160 N R B

1 2 3 4 5 6 7 8 9

1 Type

CS : SMD
SA : ARRAY

2 Size Code

This is expressed in tens of a millimeter.
The first two digits are the length, the last two digits are width.

| Size(mm) | 0603 | 1005 | 1608 | 2012 | 3216 | 3225 | 4520 | 4532 | 5750 |
|----------|------|------|------|------|------|------|------|------|------|
|----------|------|------|------|------|------|------|------|------|------|

3 Temperature Coefficient Code

| Temperature Characteristic | Temperature Range | Capacitance Change or Temperature Coefficient | Operating Temperature Range |
|----------------------------|-------------------|---|-----------------------------|
| C0G | -55 to 125°C | 0±30ppm/°C | -55 to 125°C |
| X7R | -55 to 125°C | ±15% | -55 to 125°C |
| X5R | -55 to 85°C | ±15% | -55 to 85°C |
| Y5V | -30 to 85°C | +22, -82% | -30 to 85°C |

4 Capacitance Code(Pico Farads)

The nominal capacitance value in pF is expressed by three digit numbers.

The first two digits represents significant figures and the last digit denotes the number of zero

Ex.) 104 = 100000pF R denotes decimal 8R2 = 8.2pF

5 Capacitance Tolerance Code

| Code | Tolerance | Code | Tolerance |
|------|-----------|------|------------|
| B | ±0.1pF | M | ±20% |
| C | ±0.25pF | P | +100, -0% |
| D | ±0.5pF | Z | +80, -20% |
| F | ±1.0% | H | +0.25/-0pF |
| G | ±2.0% | I | +0/-0.25pF |
| J | ±5% | U | +5/-0% |
| K | ±10% | V | +0/-5% |

6 Voltage Code

| Code | 6R3 | 100 | 160 | 250 | 500 | 101 | 201 | 251 | 631 | 302 |
|------|---------|--------|--------|--------|--------|---------|---------|---------|---------|----------|
| Vol. | DC 6.3V | DC 10V | DC 16V | DC 25V | DC 50V | DC 100V | DC 200V | DC 250V | DC 630V | DC 3000V |

7 Termination Code

Ex.) N : Ni-Sn(Nickel-Tin Plate)

8 Packing Code

Ex.) R : Reel Type B : Bulk Type

9 Thickness Option

| Size(mm) | Thickness(mm) | | Code | Size(mm) | Thickness(mm) | | Code |
|-----------|---------------|--------|------|----------------|---------------|--------|------|
| | t | Tol(±) | | | t | Tol(±) | |
| 0603/1005 | 0.3 | 0.03 | - | 3216 | 1.15 | 0.15 | E |
| 1005 | 0.5 | 0.05 | - | 3216/3225 | 1.6 | 0.2 | I |
| 2012 | 0.6 | 0.1 | A | 3225 | 1.8 | 0.2 | J |
| 1608 | 0.8 | 0.1 | B | 3225/4532/5750 | 2 | 0.25 | K |
| 2012/3216 | 0.85 | 0.15 | B | 3225/4532/5750 | 2.5 | 0.25 | L |
| 2012 | 1.25 | 0.15 | E | | | | |

| Size(mm) | Code | Packaging | Size(mm) | Code | Packaging |
|-----------|------|-----------------|----------------|------|-----------------|
| 0603/1005 | - | Paper Taping | 3216 | E | Embossed Taping |
| 1005 | - | Paper Taping | 3216/3225 | I | Embossed Taping |
| 2012 | A | Paper Taping | 3225 | J | Embossed Taping |
| 1608 | B | Paper Taping | 3225/4532/5750 | K | Embossed Taping |
| 2012/3216 | B | Paper Taping | 3225/4532/5750 | L | Embossed Taping |
| 2012 | E | Embossed Taping | | | |

SMD Type

Typical Performance Characteristics

COG

Application

Suited for precision circuits, requiring stable dielectric characteristics, negligible dependence of capacitance and dissipation factor on time, voltage and frequency.

Dielectric Characteristics

| | |
|----------------------------|--|
| Temperature Characteristic | $0 \pm 30 \text{ppm}/^\circ\text{C}$ |
| Operating Temperature | $-55 \sim 125^\circ\text{C}$ |
| Capacitance Tolerance | $> 10 \text{pF} : \pm 5\%, \pm 10\%, (\pm 1\%, \pm 2\%, \pm 20\%)$ $\leq 10 \text{pF} : \pm 0.1 \text{pF}, \pm 0.25 \text{pF}, \pm 0.5 \text{pF}$ |
| Dissipation Factor & Q | $\geq 30 \text{pF} : \text{DF} \leq 0.1\%, Q \geq 1000$ $< 30 \text{pF} : Q \geq 400 + 20 \times C$ |
| Insulation Resistance | More than $10,000 \text{M}\Omega$ or $500 \Omega\text{F}$ (Whichever is smaller) |
| Dielectric Strength | $> 3 \times \text{RVDC}$ |
| Test Voltage | $0.5 \text{ to } 5 \text{Vrms} (\leq 1000 \text{pF}), 1 \pm 0.2 \text{Vrms} (> 1000 \text{pF})$ |
| Test Frequency | $1 \pm 0.1 \text{MHz} (\leq 1000 \text{pF}), 1 \pm 0.1 \text{kHz} (> 1000 \text{pF})$ |

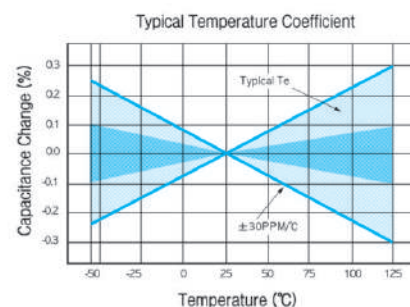

X7R

Application

Stable class II dielectric properties, suited for by-pass and coupling purposes, filtering, frequency discrimination, DC blockage, and as voltage transient suppression elements.

Dielectric Characteristics

| | |
|----------------------------|---|
| Temperature Characteristic | $\pm 15\%$ |
| Operating Temperature | $-55 \sim 125^\circ\text{C}$ |
| Capacitance Tolerance | $\pm 10\%, \pm 20\%, (\pm 5\%, +80 \sim -20\%)$ |
| Dissipation Factor & Q | $50 \text{V Min.} : 2.5\% \text{ Max.}$ $25 \text{V Min.} : 3.0\% \text{ Max.}$ $16 \text{V Min.} : 3.5\% \text{ Max.}$ $10 \text{V Min.} : 5.0\% \text{ Max.}$ $6.3 \text{V Min.} : 5.0\% \text{ Max.}$ Thin layer large capacitors type 12.5% Max. |
| Insulation Resistance | More than $10,000 \text{M}\Omega$ or $500 \Omega\text{F}$ (Whichever is smaller) Thin layer large capacitors type $50 \Omega\text{F}$ Min. |
| Dielectric Strength | $> 2.5 \times \text{RVDC}$ |
| Test Voltage | $1 \pm 0.2 \text{Vrms} (\leq 10 \mu\text{F})$ $0.5 \pm 0.1 \text{Vrms} (> 10 \mu\text{F})$ |
| Test Frequency | $1 \pm 0.1 \text{kHz} (\leq 10 \mu\text{F})$ $120 \pm 24 \text{Hz} (> 10 \mu\text{F})$ |

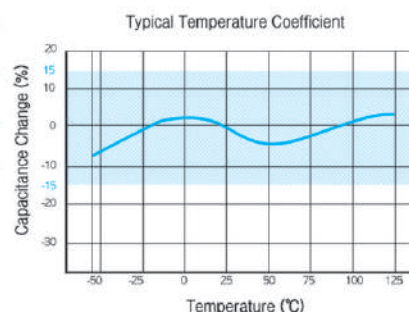

X5R

Application

Stable class II dielectric properties, suited for by-pass and coupling purposes, filtering, frequency discrimination, DC blockage, and as voltage transient suppression elements.

Dielectric Characteristics

| | |
|----------------------------|--|
| Temperature Characteristic | ±15% |
| Operating Temperature | -55~85°C |
| Capacitance Tolerance | ±10%, ±20%, (±5%, +80~-20%) |
| Dissipation Factor & Q | 50V Min. : 2.5% Max. 25V Min. : 3.0% Max. 16V Min. : 3.5% Max. 10V Min. : 5.0% Max. 6.3V Min. : 5.0% Max. Thin layer large capacitors type 12.5% Max. |
| Insulation Resistance | More than 10,000MΩ or 500ΩF (Whichever is smaller) Thin layer large capacitors type 50ΩF Min. |
| Dielectric Strength | >2.5×RVDC |
| Test Voltage | 1±0.2Vrms(≤10μF) 0.5±0.1Vrms(>10μF) |
| Test Frequency | 1±0.1kHz(≤10μF) 120±24Hz(>10μF) |

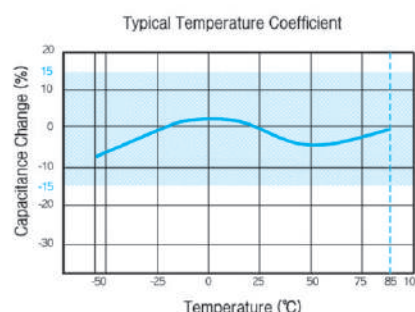

Y5V

Application

The Hi-K(Y5V) dielectrics deliver high capacitance density and are ideally suited for applications where space is at a premium, or as replacement for tantalum capacitors. Typically applications include use as by-pass or decoupling elements. Best performance is obtained at or near room temperature, with low DC bias.

Dielectric Characteristics

| | |
|----------------------------|--|
| Temperature Characteristic | +22%~-82% |
| Operating Temperature | -30~85°C |
| Capacitance Tolerance | -20~+80% (±20%) |
| Dissipation Factor & Q | 50V Min. : 5% Max. 25V Min. : 7% Max. 16V Min. : 9% Max. 10V Min. : 12.5% Max. 6.3V Min. : 15% Max. Thin layer large capacitors type 20% Max. |
| Insulation Resistance | More than 10,000MΩ or 500ΩF (Whichever is smaller) Thin layer large capacitors type 50ΩF Min. |
| Dielectric Strength | >2.5×RVDC |
| Test Voltage | 1±0.2Vrms(≤10μF) 0.5±0.1Vrms(>10μF) |
| Test Frequency | 1±0.1kHz(≤10μF) 120±24Hz(>10μF) |

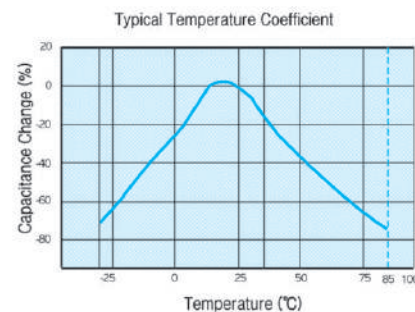

SMD Type

Appendix I

C0G-Temperature Compensating Type(0603~3216)

| Type Size(inch) | C0G | | | | | | | | | |
|--------------------|------------|-----|------------|-----|------------|-----|------------|------|------------|------|
| | 0603(0201) | | 1005(0402) | | 1608(0603) | | 2012(0805) | | 3216(1206) | |
| Volt(V) Cap. | 25 | 50 | 25 | 50 | 25 | 50 | 25 | 50 | 25 | 50 |
| 0.5pF(0R5) | | | | | | | | | | |
| 1pF(010) | | | | | | | | | | |
| 2pF(020) | | | | | | | | | | |
| 3pF(030) | | | | | | | | | | |
| 4pF(040) | | | | | | | | | | |
| 5pF(050) | | | | | | | | | | |
| 6pF(060) | | | | | | | | | | |
| 7pF(070) | | | | | | | | | | |
| 8pF(080) | | | | | | | | | | |
| 9pF(090) | | | | | | | | | | |
| 10pF(100) | | | | | | | | | | |
| 12pF(120) | | | | | | | | | | |
| 15pF(150) | | | | | | | | | | |
| 18pF(180) | | | | | | | | | | |
| 22pF(220) | | | | | | | | | | |
| 27pF(270) | | | | | | | | | | |
| 33pF(330) | | | | | | | | | | |
| 39pF(390) | | | | | | | | | | |
| 47pF(470) | | | | | | | | | | |
| 56pF(560) | | | | | | | | | | |
| 68pF(680) | | | | | | | | | | |
| 82pF(820) | | | | | | | | | | |
| 100pF(101) | | | | | | | | | | |
| 120pF(121) | | | | | | | | | | |
| 150pF(151) | | | | | | | | | | |
| 180pF(181) | | | | | | | | | | |
| 220pF(221) | | 0.3 | | | | | | | | |
| 270pF(271) | | | | | | | | | | |
| 330pF(331) | | | | | | | | | | |
| 390pF(391) | | | | | | | | | | |
| 470pF(471) | | | | | | | | | | |
| 560pF(561) | | | | | | | | | | |
| 680pF(681) | | | | | | | | | | |
| 820pF(821) | | | | | | | | | | |
| 1000pF(102) | 0.3 | | | | | | | | | |
| 1200pF(122) | | | | | | | | | | |
| 1500pF(152) | | | | | | | | | | |
| 1800pF(182) | | | | | | | | | 1.15 | 1.15 |
| 2200pF(222) | | | | | | | 0.6 | 0.6 | | |
| 2700pF(272) | | | | | | | | | | |
| 3300pF(332) | | | | | | | | | | |
| 3900pF(392) | | | | | | | | | | |
| 4700pF(472) | | | | | | | | | | |
| 5600pF(562) | | | | | | | | | | |
| 6800pF(682) | | | | | | | | | | |
| 8200pF(822) | | | | | | | | | | |
| 10000pF(103) | | | 0.5 | 0.5 | 0.8 | 0.8 | | | | |
| 12000pF(123) | | | | | | | | | | |
| 15000pF(153) | | | | | | | | | | |
| 18000pF(183) | | | | | | | | | | |
| 22000pF(223) | | | | | | | | | | |
| 27000pF(273) | | | | | | | | | | |
| 33000pF(333) | | | | | | | 1.25 | 1.25 | | |
| 47000pF(473) | | | | | | | | | | |
| 56000pF(563) | | | | | | | | | | |
| 68000pF(683) | | | | | | | | | | |
| 82000pF(823) | | | | | | | | | | |
| 0.1μF(104) | | | | | | | | | 1.60 | 1.60 |

Temperature Compensating Type : Dissipation Factor Page 22 (No.5)

Appendix II

X7R-High Dielectric Constant Type(0603~3225) & Thin Layer Large-Capacitance Type

| Type | X7R | | | | | | | | | | | | | | | | | | | | | | | | | | | | | | | | | |
|--------------|------------|----|----|----|------------|----|----|----|----|------------|----|----|----|----|------------|----|----|----|----|------------|----|----|----|----|------------|----|----|----|----|-----|----|----|----|----|
| | 0603(0201) | | | | 1005(0402) | | | | | 1608(0603) | | | | | 2012(0805) | | | | | 3216(1206) | | | | | 3225(1210) | | | | | | | | | |
| Size(inch) | | | | | | | | | | | | | | | | | | | | | | | | | | | | | | | | | | |
| Volt(V) | | | | | | | | | | | | | | | | | | | | | | | | | | | | | | | | | | |
| Cap. | 6.3 | 10 | 16 | 25 | 6.3 | 10 | 16 | 25 | 50 | 6.3 | 10 | 16 | 25 | 50 | 6.3 | 10 | 16 | 25 | 50 | 6.3 | 10 | 16 | 25 | 50 | 6.3 | 10 | 16 | 25 | 50 | 6.3 | 10 | 16 | 25 | 50 |
| 100pF(101) | | | | | | | | | | | | | | | | | | | | | | | | | | | | | | | | | | |
| 470pF(471) | | | | | | | | | | | | | | | | | | | | | | | | | | | | | | | | | | |
| 1000pF(102) | | | | | | | | | | | | | | | | | | | | | | | | | | | | | | | | | | |
| 2200pF(222) | | | | | | | | | | | | | | | | | | | | | | | | | | | | | | | | | | |
| 4700pF(472) | | | | | | | | | | | | | | | | | | | | | | | | | | | | | | | | | | |
| 10000pF(103) | ▼ | ▼ | ▼ | ▼ | | | | | | | | | | | | | | | | | | | | | | | | | | | | | | |
| 15000pF(153) | | | | | | | | | | | | | | | | | | | | | | | | | | | | | | | | | | |
| 22000pF(223) | | | | | | | | | | | | | | | | | | | | | | | | | | | | | | | | | | |
| 33000pF(333) | | | | | | | | | | | | | | | | | | | | | | | | | | | | | | | | | | |
| 47000pF(473) | | | | | | | | | | | | | | | | | | | | | | | | | | | | | | | | | | |
| 68000pF(683) | | | | | | | | | | | | | | | | | | | | | | | | | | | | | | | | | | |
| 0.1μF(104) | | | | | | | | | | | | | | | | | | | | | | | | | | | | | | | | | | |
| 0.15μF(154) | | | | | | | | | | | | | | | | | | | | | | | | | | | | | | | | | | |
| 0.22μF(224) | | | | | | | | | | | | | | | | | | | | | | | | | | | | | | | | | | |
| 0.33μF(334) | | | | | | | | | | | | | | | | | | | | | | | | | | | | | | | | | | |
| 0.47μF(474) | | | | | | | | | | | | | | | | | | | | | | | | | | | | | | | | | | |
| 0.68μF(684) | | | | | | | | | | | | | | | | | | | | | | | | | | | | | | | | | | |
| 1.0μF(105) | | | | | | | | | | | | | | | | | | | | | | | | | | | | | | | | | | |
| 1.5μF(155) | | | | | | | | | | | | | | | | | | | | | | | | | | | | | | | | | | |
| 2.2μF(225) | | | | | | | | | | | | | | | | | | | | | | | | | | | | | | | | | | |
| 4.7μF(475) | | | | | | | | | | | | | | | | | | | | | | | | | | | | | | | | | | |
| 6.8μF(685) | | | | | | | | | | | | | | | | | | | | | | | | | | | | | | | | | | |
| 10μF(106) | | | | | | | | | | | | | | | | | | | | | | | | | | | | | | | | | | |
| 22μF(226) | | | | | | | | | | | | | | | | | | | | | | | | | | | | | | | | | | |
| 47μF(476) | | | | | | | | | | | | | | | | | | | | | | | | | | | | | | | | | | |
| 100μF(107) | | | | | | | | | | | | | | | | | | | | | | | | | | | | | | | | | | |

- General Type : Dissipation Factor Page 22(No.5)
- * General Type : Dissipation Factor Page 22(No.5)
- Thin Layer Large-Capacitance Type : Dissipation Factor Page 22(No.5)

SMD Type

X5R-High Dielectric Constant Type(0603~3225) & Thin Layer Large-Capacitance Type

| Type | X5R | | | | | | | | | | | | | | | | | | | | | | | | | | | | |
|--------------|------------|----|----|----|------------|----|----|----|----|------------|----|----|----|----|------------|----|----|----|----|------------|----|----|----|----|------------|----|----|----|----|
| | 0603(0201) | | | | 1005(0402) | | | | | 1608(0603) | | | | | 2012(0805) | | | | | 3216(1206) | | | | | 3225(1210) | | | | |
| Volt(V) | | | | | | | | | | | | | | | | | | | | | | | | | | | | | |
| Cap. | 6.3 | 10 | 16 | 25 | 6.3 | 10 | 16 | 25 | 50 | 6.3 | 10 | 16 | 25 | 50 | 6.3 | 10 | 16 | 25 | 50 | 6.3 | 10 | 16 | 25 | 50 | 6.3 | 10 | 16 | 25 | 50 |
| 100pF(101) | | | | | | | | | | | | | | | | | | | | | | | | | | | | | |
| 470pF(471) | | | | | | | | | | | | | | | | | | | | | | | | | | | | | |
| 1000pF(102) | | | | | | | | | | | | | | | | | | | | | | | | | | | | | |
| 2200pF(222) | | | | | | | | | | | | | | | | | | | | | | | | | | | | | |
| 4700pF(472) | | | | | | | | | | | | | | | | | | | | | | | | | | | | | |
| 10000pF(103) | | | | | | | | | | | | | | | | | | | | | | | | | | | | | |
| 15000pF(153) | | | | | | | | | | | | | | | | | | | | | | | | | | | | | |
| 22000pF(223) | | | | | | | | | | | | | | | | | | | | | | | | | | | | | |
| 33000pF(333) | | | | | | | | | | | | | | | | | | | | | | | | | | | | | |
| 47000pF(473) | | | | | | | | | | | | | | | | | | | | | | | | | | | | | |
| 68000pF(683) | | | | | | | | | | | | | | | | | | | | | | | | | | | | | |
| 0.1μF(104) | | | | | | | | | | | | | | | | | | | | | | | | | | | | | |
| 0.15μF(154) | | | | | | | | | | | | | | | | | | | | | | | | | | | | | |
| 0.22μF(224) | | | | | | | | | | | | | | | | | | | | | | | | | | | | | |
| 0.33μF(334) | | | | | | | | | | | | | | | | | | | | | | | | | | | | | |
| 0.47μF(474) | | | | | | | | | | | | | | | | | | | | | | | | | | | | | |
| 0.68μF(684) | | | | | | | | | | | | | | | | | | | | | | | | | | | | | |
| 1.0μF(105) | | | | | | | | | | | | | | | | | | | | | | | | | | | | | |
| 1.5μF(155) | | | | | | | | | | | | | | | | | | | | | | | | | | | | | |
| 2.2μF(225) | | | | | | | | | | | | | | | | | | | | | | | | | | | | | |
| 4.7μF(475) | | | | | | | | | | | | | | | | | | | | | | | | | | | | | |
| 6.8μF(685) | | | | | | | | | | | | | | | | | | | | | | | | | | | | | |
| 10μF(106) | | | | | | | | | | | | | | | | | | | | | | | | | | | | | |
| 22μF(226) | | | | | | | | | | | | | | | | | | | | | | | | | | | | | |
| 47μF(476) | | | | | | | | | | | | | | | | | | | | | | | | | | | | | |
| 100μF(107) | | | | | | | | | | | | | | | | | | | | | | | | | | | | | |

- General Type : Dissipation Factor Page 22(No.5)
- * General Type : Dissipation Factor Page 22(No.5)
- Thin Layer Large-Capacitance Type : Dissipation Factor Page 22(No.5)

Y5V-High Dielectric Constant Type(0603~3225) & Thin Layer Large-Capacitance Type

| Type | Y5V | | | | | | | | | | | | | | | | | | | | | | | | |
|--------------|------------|--|----|----|----|------------|-----|--|----|----|------------|----|-----|--|----|------------|----|----|-----|--|------------|----|----|----|--|
| | 1005(0402) | | | | | 1608(0603) | | | | | 2012(0805) | | | | | 3216(1206) | | | | | 3225(1210) | | | | |
| | 6.3 | | 10 | 16 | 25 | 50 | 6.3 | | 10 | 16 | 25 | 50 | 6.3 | | 10 | 16 | 25 | 50 | 6.3 | | 10 | 16 | 25 | 50 | |
| 1000pF(102) | | | | | | | | | | | | | | | | | | | | | | | | | |
| 2200pF(222) | | | | | | | | | | | | | | | | | | | | | | | | | |
| 4700pF(472) | | | | | | | | | | | | | | | | | | | | | | | | | |
| 10000pF(103) | | | | | | | | | | | | | | | | | | | | | | | | | |
| 15000pF(153) | | | | | | | | | | | | | | | | | | | | | | | | | |
| 22000pF(223) | | | | | | | | | | | | | | | | | | | | | | | | | |
| 33000pF(333) | | | | | | | | | | | | | | | | | | | | | | | | | |
| 47000pF(473) | | | | | | | | | | | | | | | | | | | | | | | | | |
| 68000pF(683) | | | | | | | | | | | | | | | | | | | | | | | | | |
| 0.1μF(104) | | | | | | | | | | | | | | | | | | | | | | | | | |
| 0.15μF(154) | | | | | | | | | | | | | | | | | | | | | | | | | |
| 0.22μF(224) | | | | | | | | | | | | | | | | | | | | | | | | | |
| 0.33μF(334) | | | | | | | | | | | | | | | | | | | | | | | | | |
| 0.47μF(474) | | | | | | | | | | | | | | | | | | | | | | | | | |
| 0.68μF(684) | | | | | | | | | | | | | | | | | | | | | | | | | |
| 1.0μF(105) | | | | | | | | | | | | | | | | | | | | | | | | | |
| 1.5μF(155) | | | | | | | | | | | | | | | | | | | | | | | | | |
| 2.2μF(225) | | | | | | | | | | | | | | | | | | | | | | | | | |
| 3.3μF(335) | | | | | | | | | | | | | | | | | | | | | | | | | |
| 4.7μF(475) | | | | | | | | | | | | | | | | | | | | | | | | | |
| 6.8μF(685) | | | | | | | | | | | | | | | | | | | | | | | | | |
| 10μF(106) | | | | | | | | | | | | | | | | | | | | | | | | | |
| 22μF(226) | | | | | | | | | | | | | | | | | | | | | | | | | |
| 47μF(476) | | | | | | | | | | | | | | | | | | | | | | | | | |
| 100μF(107) | | | | | | | | | | | | | | | | | | | | | | | | | |

- General Type : Dissipation Factor Page 22(No.5)
- * General Type : Dissipation Factor Page 22(No.5)
- Thin Layer Large-Capacitance Type : Dissipation Factor Page 22(No.5)

SMD Type-High Voltage

Product Offering

SAMWHA high voltage MLCC products with the temperature characteristics of C0G and X7R are designed for commercial and industrial applications. The products are applied to DC-DC converters and ballast circuit to reduce ripple noise and diverting potentially unsafe transients in various sizes with working voltage up to DC 7kV. These high voltage capacitors feature a special internal electrode design which has capacitor network to reduce voltage concentrations by distributing voltage throughout the entire capacitor.

Features

- High reliability
- The highest voltage rating by the special internal electrode design
- Wide voltage level : from 100V_{DC} to 7,000V_{DC}
- Surface mount suited for wave and reflow soldering
- RoHS compliant

Applications

- DC-DC Converters
- Network Equipments
- Back-Lighting Inverter
- Lighting Ballast
- Modem & Power Supply
- LAN/WLAN Interface

※ special specification like a Automobile, Medical, Military, Aviation should be discuss with our sales representatives

Special Options for the Safety

- Inset electrode margins to prevent short mode failure resulted from the crack by mechanical bending stress
- Soft termination is optionally available to reduce possibility for the crack of MLCCs by mechanical bending stress

How to Order (Product Identification)

CS 4532 X7R 471 K 302 N R K

1 2 3 4 5 6 7 8 9

1 Type

CS : SMD

2 Size Code

| Size(mm) | 1608 | 2012 | 3216 | 3225 | 4520 | 4532 | 5750 | 7566 | 9595 |
|----------|------|------|------|------|------|------|------|------|------|
|----------|------|------|------|------|------|------|------|------|------|

3 Dielectric (Temp. Coefficient)

COG, X7R

4 Capacitance

1st two digits are value, 3rd digit denotes number of zeros;
331 = 330pF, 104 = 100000pF, 8R2 = 8.2pF

5 Tolerance

| Code | Tolerance | Code | Tolerance |
|------|-----------|------|-----------|
| B | ±0.1pF | C | ±0.25pF |
| D | ±0.50pF | F | ±1% |
| G | ±2% | J | ±5% |
| K | ±10% | M | ±20% |
| Z | +80~-20% | | |

6 Rated Voltage Code

1st two digits are value, 3rd digit denotes number of zeros; 302 = 3,000V, 502 = 5,000V, 722 = 7,200V

7 Plating

Ni / Sn Plated

8 Packing

B : Bulk Pack R : Reel Pack C : Case Box

9 Thickness Option

| Size(mm) | Thickness(mm) | | Code | Size(mm) | Thickness(mm) | | Code |
|-----------|---------------|--------|------|----------------|---------------|--------|------|
| | t | Tol(±) | | | t | Tol(±) | |
| 0603/1005 | 0.3 | 0.03 | - | 3216 | 1.15 | 0.15 | E |
| 1005 | 0.5 | 0.05 | - | 3216/3225 | 1.6 | 0.2 | I |
| 2012 | 0.6 | 0.1 | A | 3225 | 1.8 | 0.2 | J |
| 1608 | 0.8 | 0.1 | B | 3225/4532/5750 | 2 | 0.25 | K |
| 2012/3216 | 0.85 | 0.15 | B | 3225/4532/5750 | 2.5 | 0.25 | L |
| 2012 | 1.25 | 0.15 | E | | | | |

| Size(mm) | Code | Packaging | Size(mm) | Code | Packaging |
|-----------|------|-----------------|----------------|------|-----------------|
| 0603/1005 | - | Paper Taping | 3216 | E | Embossed Taping |
| 1005 | - | Paper Taping | 3216/3225 | I | Embossed Taping |
| 2012 | A | Paper Taping | 3225 | J | Embossed Taping |
| 1608 | B | Paper Taping | 3225/4532/5750 | K | Embossed Taping |
| 2012/3216 | B | Paper Taping | 3225/4532/5750 | L | Embossed Taping |
| 2012 | E | Embossed Taping | | | |

SMD Type-High Voltage

Shape & Dimensions

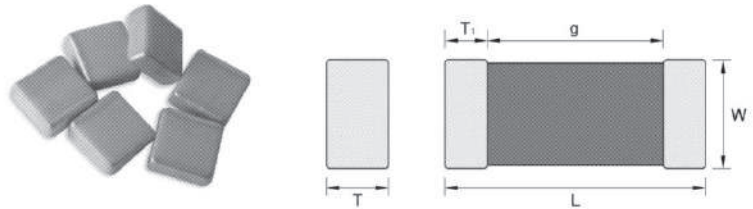

(Unit : mm)

| Code | Dimensions | | | | |
|------------|------------|--------|-------|--------|---------|
| | Length | | Width | | T1(min) |
| | L | Tol(±) | W | Tol(±) | |
| 1608(0603) | 1.60 | 0.15 | 0.80 | 0.10 | 0.10 |
| 2012(0805) | 2.00 | 0.20 | 1.25 | 0.15 | 0.10 |
| 3216(1206) | 3.20 | 0.30 | 1.60 | 0.20 | 0.15 |
| 3225(1210) | 3.20 | 0.40 | 2.50 | 0.25 | 0.15 |
| 4520(1808) | 4.50 | 0.40 | 2.00 | 0.25 | 0.20 |
| 4532(1812) | 4.50 | 0.40 | 3.20 | 0.30 | 0.20 |
| 5750(2220) | 5.70 | 0.50 | 5.00 | 0.40 | 0.30 |
| 7566(3026) | 7.50 | 0.50 | 6.60 | 0.50 | 0.30 |
| 9595(3838) | 9.50 | 0.50 | 9.50 | 0.50 | 0.30 |

*1608 Size $\geq 10\mu\text{F} \Rightarrow W : 0.8\pm 0.15, T : 0.8\pm 0.15$

Typical Performance Characteristics

Dielectric Characteristics

COG(NPO)

X7R

| | | |
|--|--|---|
| Dielectric Classification | Ultra Stable | Stable |
| Rated temperature range | -55°C to +125°C | -55°C to +125°C |
| TCC(Temperature Characteristics Coefficient) | 0±30ppm | ±15% |
| Dissipation Factor(tan δ) | C≥30pF : Q≥1,000 (DF:≤ 0.1%) C<30pF : Q≥400+20C(DF: ≤1/(400+20C)) | 2.5% Max. |
| IR(Insulation Resistance) | 500V Below : Rated voltage 2Min 500V Above : 500V 2Min More than 10,000 MΩ | 500V Below:Rated voltage 2Min 500V Above:500V 2Min -DC100V~1KV :C≥0.01μF:More than 100MΩμF :C<0.01μF:More than 10,000MΩ -DC2~3KV:More than6,000 MΩ |
| Capacitance Tolerance | <10pF : ±0.25pF, ±0.5pF ≥10pF : ±5%, ±0% | ±10%, ±20% |
| Dielectric strength | 630V:150% Rated Voltage 1kV~7.2kV:120% Rated Voltage | 100V:150% Rated Voltage 630V:150% Rated Voltage 1kV~7.2kV: 120% Rated Voltage |
| Aging characteristics | 0% | 2.5% per decade hr, typical |

Appendix High Voltage Type(100V~3000V)

COG-Temperature Compensation Type

High voltage type

| Type | COG | | | | | | | | | | | | | | | | | | | | | | | | | | | | | | | |
|-----------------|------------|-----|------------|-----|------------|-----|-----|------|------------|-----|-----|-----|------------|------|-----|-----|-----|------------|------|------|-----|-----|------------|------|------------|------|------|------|------|------|------|------|
| | 1608(0603) | | 2012(0805) | | 3216(1206) | | | | 3225(1210) | | | | 4520(1808) | | | | | 4532(1812) | | | | | 7066(3026) | | 9595(3838) | | | | | | | |
| Size(inch) | 100 | 250 | 100 | 250 | 100 | 250 | 630 | 1000 | 2000 | 100 | 250 | 630 | 1000 | 2000 | 100 | 250 | 630 | 1000 | 2000 | 3000 | 100 | 250 | 630 | 1000 | 2000 | 3000 | 3000 | 4000 | 3000 | 4000 | 5000 | 7000 |
| Volt(V) Cap. | | | | | | | | | | | | | | | | | | | | | | | | | | | | | | | | |
| 4.7 pF(4R7) | | | | | | | | | | | | | | | | | | | | | | | | | | | | | | | | |
| 5 pF(050) | | | | | | | | | | | | | | | | | | | | | | | | | | | | | | | | |
| 7 pF(070) | | | | | | | | | | | | | | | | | | | | | | | | | | | | | | | | |
| 8 pF(080) | | | | | | | | | | | | | | | | | | | | | | | | | | | | | | | | |
| 9 pF(090) | | | | | | | | | | | | | | | | | | | | | | | | | | | | | | | | |
| 10 pF(100) | | | | | | | | | | | | | | | | | | | | | | | | | | | | | | | | |
| 12 pF(120) | | | | | | | | | | | | | | | | | | | | | | | | | | | | | | | | |
| 15 pF(150) | | | | | | | | | | | | | | | | | | | | | | | | | | | | | | | | |
| 18 pF(180) | | | | | | | | | | | | | | | | | | | | | | | | | | | | | | | | |
| 22 pF(220) | | | | | | | | | | | | | | | | | | | | | | | | | | | | | | | | |
| 47 pF(470) | | | | | | | | | | | | | | | | | | | | | | | | | | | | | | | | |
| 56 pF(560) | | | | | | | | | | | | | | | | | | | | | | | | | | | | | | | | |
| 68 pF(680) | | | | | | | | | | | | | | | | | | | | | | | | | | | | | | | | |
| 82 pF(820) | | | | | | | | | | | | | | | | | | | | | | | | | | | | | | | | |
| 100 pF(101) | | | | | | | | | | | | | | | | | | | | | | | | | | | | | | | | |
| 180 pF(180) | | | | | | | | | | | | | | | | | | | | | | | | | | | | | | | | |
| 220 pF(221) | | | | | | | | | | | | | | | | | | | | | | | | | | | | | | | | |
| 330 pF(331) | | | | | | | | | | | | | | | | | | | | | | | | | | | | | | | | |
| 470 pF(471) | | | | | | | | | | | | | | | | | | | | | | | | | | | | | | | | |
| 560 pF(561) | | | | | | | | | | | | | | | | | | | | | | | | | | | | | | | | |
| 680 pF(681) | | | | | | | | | | | | | | | | | | | | | | | | | | | | | | | | |
| 1000 pF(102) | | | | | | | | | | | | | | | | | | | | | | | | | | | | | | | | |
| 1500 pF(152) | | | | | | | | | | | | | | | | | | | | | | | | | | | | | | | | |
| 2200 pF(222) | | | | | | | | | | | | | | | | | | | | | | | | | | | | | | | | |
| 2700 pF(272) | | | | | | | | | | | | | | | | | | | | | | | | | | | | | | | | |
| 3300 pF(332) | | | | | | | | | | | | | | | | | | | | | | | | | | | | | | | | |
| 4700 pF(472) | | | | | | | | | | | | | | | | | | | | | | | | | | | | | | | | |
| 5600 pF(562) | | | | | | | | | | | | | | | | | | | | | | | | | | | | | | | | |
| 6800 pF(682) | | | | | | | | | | | | | | | | | | | | | | | | | | | | | | | | |
| 10000 pF(103) | | | | | | | | | | | | | | | | | | | | | | | | | | | | | | | | |
| 15000 pF(153) | | | | | | | | | | | | | | | | | | | | | | | | | | | | | | | | |
| 22000 pF(223) | | | | | | | | | | | | | | | | | | | | | | | | | | | | | | | | |
| 33000 pF(333) | | | | | | | | | | | | | | | | | | | | | | | | | | | | | | | | |

SMD Type-High Voltage

X7R-High Dielectric Type

High voltage type

| Type | X7R | | | | | | | | | | | | | | | | | | | | | | | | | |
|-----------------|------------|-----|------------|-----|------------|-----|-----|------|------|------------|-----|-----|------|------|------------|-----|-----|------|------|------------|-----|-----|-----|------|------|------|
| | 1608(0603) | | 2012(0805) | | 3216(1206) | | | | | 3225(1210) | | | | | 4520(1808) | | | | | 4532(1812) | | | | | | |
| Volt(V) Cap. | 100 | 250 | 100 | 250 | 100 | 250 | 630 | 1000 | 2000 | 100 | 250 | 630 | 1000 | 2000 | 100 | 250 | 630 | 1000 | 2000 | 3000 | 100 | 250 | 630 | 1000 | 2000 | 3000 |
| 220 pF (221) | | | | | | | | | | | | | | | | | | | | | | | | | | |
| 330 pF (331) | | | | | | | | | | | | | | | | | | | | | | | | | | |
| 470 pF (471) | | | | | | | | | | | | | | | | | | | | | | | | | | |
| 680 pF (681) | | | | | | | | | | | | | | | | | | | | | | | | | | |
| 1000 pF (102) | | | | | | | | | | | | | | | | | | | | | | | | | | |
| 1500 pF (152) | | | | | | | | | | | | | | | | | | | | | | | | | | |
| 2200 pF (222) | | | | | | | | | | | | | | | | | | | | | | | | | | |
| 3300 pF (332) | | | | | | | | | | | | | | | | | | | | | | | | | | |
| 4700 pF (472) | | | | | | | | | | | | | | | | | | | | | | | | | | |
| 5600 pF (562) | | | | | | | | | | | | | | | | | | | | | | | | | | |
| 6800 pF (682) | | | | | | | | | | | | | | | | | | | | | | | | | | |
| 10000 pF (103) | | | | | | | | | | | | | | | | | | | | | | | | | | |
| 15000 pF (153) | | | | | | | | | | | | | | | | | | | | | | | | | | |
| 18000 pF (183) | | | | | | | | | | | | | | | | | | | | | | | | | | |
| 22000 pF (223) | | | | | | | | | | | | | | | | | | | | | | | | | | |
| 33000 pF (333) | | | | | | | | | | | | | | | | | | | | | | | | | | |
| 47000 pF (473) | | | | | | | | | | | | | | | | | | | | | | | | | | |
| 68000 pF (683) | | | | | | | | | | | | | | | | | | | | | | | | | | |
| 0.1 μF (104) | | | | | | | | | | | | | | | | | | | | | | | | | | |
| 0.15 μF (154) | | | | | | | | | | | | | | | | | | | | | | | | | | |
| 0.22 μF (224) | | | | | | | | | | | | | | | | | | | | | | | | | | |
| 0.33 μF (334) | | | | | | | | | | | | | | | | | | | | | | | | | | |
| 0.47 μF (474) | | | | | | | | | | | | | | | | | | | | | | | | | | |
| 0.68 μF (684) | | | | | | | | | | | | | | | | | | | | | | | | | | |
| 1.0 μF (105) | | | | | | | | | | | | | | | | | | | | | | | | | | |
| 2.2 μF (225) | | | | | | | | | | | | | | | | | | | | | | | | | | |

| Size | Vr(V) | 100pF | 470pF | 1.0nF | 2.2nF | 10nF | 47nF | 100nF | 150nF |
|------|-------|-------|-------|-------|-------|------|------|-------|-------|
| 3026 | 3,000 | | | | | | | | |
| | 4,000 | | | | | | | | |
| 3838 | 3,000 | | | | | | | | |
| | 4,000 | | | | | | | | |
| | 5,000 | | | | | | | | |
| | 7,000 | | | | | | | | |

Application(Typical circuit)

DC-DC Converter

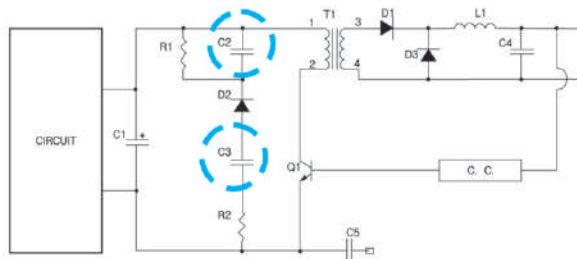

High stable operating for Tr(Q1) switching

- C2 : X7R ; 250V 10nF~47nF
- C3 : COG ; 630V 47pF~100pF

Switching Power Supply

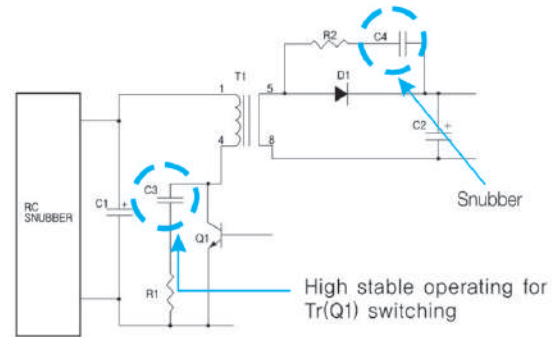

- C3 : COG, X7R ; 2kV 100pF~1000pF
- C4 : COG, X7R ; 2kV 100pF~1000pF

Primary circuit and Snubber switching power supply

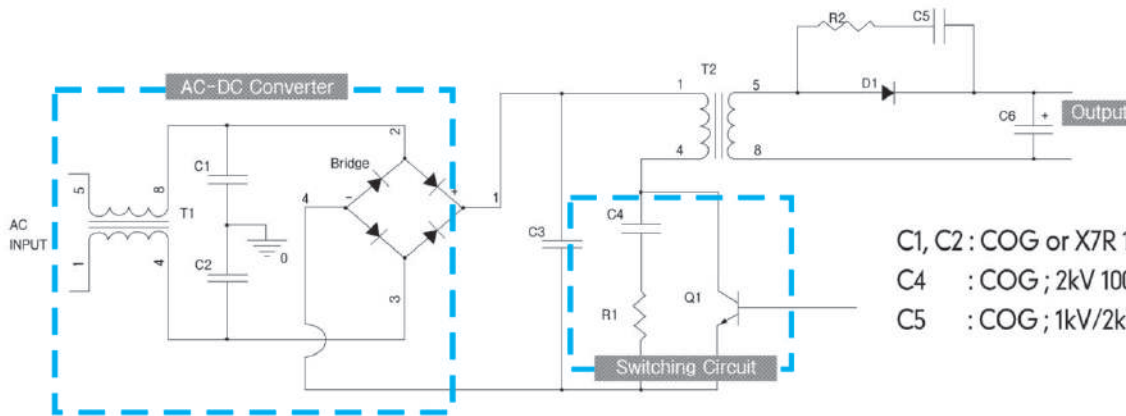

- C1, C2 : COG or X7R 1000pF~4700pF
- C4 : COG ; 2kV 100pF~330pF
- C5 : COG ; 1kV/2kV 100pF~470pF

LCD back light Inverter

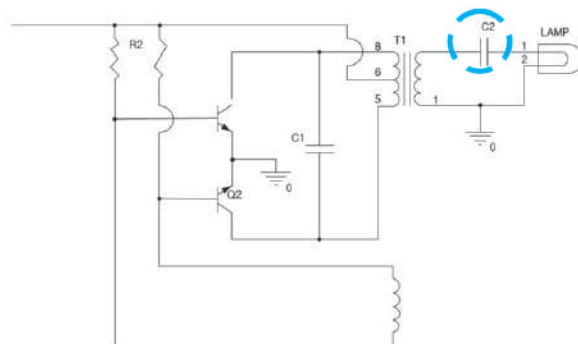

- C2 : COG ; 3kV 10 ~100pF

SMD Type-High Voltage

MLCC Applications for DC-DC Converter Modules

High voltage MLCCs are mainly used to DC-DC converter modules for industrial applications which have high input voltage of typical 48V. These are used as functions of high frequency noise filtering(decoupling) of power line and snubber capacitor to protect switching device from unsafe transients by inductance of transformer or connection line due to switching operation.

For these applications, MLCCs have merits for high allowable ripple current and high reliability.

Figure 2 shows isolated DC-DC converter circuit diagram and MLCC applications such as decoupling and snubber. Input voltage is 36~75V_{DC}(typical 48V_{DC}) for general industrial applications such as base station, server and network equipments. Decoupling MLCCs are applied to input and output(based on viewpoint of switch or transformer) power line to reduce ripple voltage, and MLCCs for snubber application used to absorb surge energy. SAMWHA MLCCs are recommended for each application as shown in Table 1.

Table 1. MLCC recommendation for isolated type DC-DC converter module

| Items | MLCC Recommendation |
|-----------------|--|
| *Input (C1, C2) | 1210 X7R 470nF 100V 1812 X7R 1.0uF 100V |
| Snubber (C3~C6) | Available wide range of products 250V ~2kV (Available up to 7.2 kV) 100pF~2.2nF(Available up to 470nF) |
| Output (C7) | (High Capacitance Application) 1210 X5R 100uF 6.3V 1206 X5R 47uF 6.3V 0805 X5R 47uF 6.3V |

*Typical input voltage of 48V for industrial application

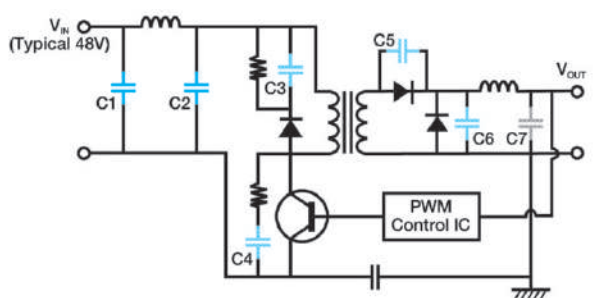

- ⊕ Input Decoupling MLCC (~1.0uF 100V)
- ⊕ Snubber Cap.(100pF~2.2nF 250V~2kV)
- ⊕ Output Decoupling MLCC(10~100uF 6.3V)

MLCC Applications for Ballast Circuits

High voltage MLCCs are suitable for the ballast circuit as a function of resonant capacitor as presented in Figure 3. MLCCs with high voltage rating from 1kV to 3kV(available up to 7.2kV) are mainly used for these application. SAMWHA offers wide range of capacitance and rated voltage with high reliability.

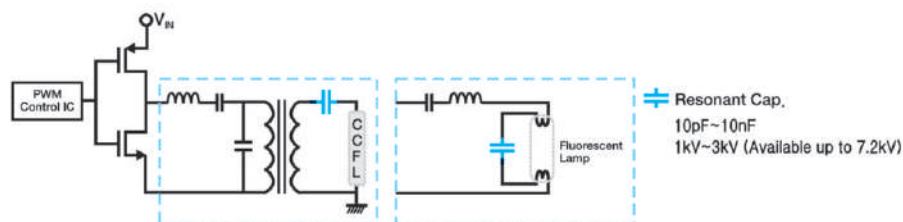

Fig. 3. Typical electronic ballast circuit and MLCC application

Caution(Rating)

1. Operating Voltage

When DC-rated capacitors are to be used in AC or ripple current circuits, be sure to maintain the V_{p-p} Value of the applied voltage or the V_{0-p} which contains DC bias within the rated voltage range.

When the voltage is applied to the circuit, starting or stopping may generate irregular voltage for a transit period because of resonance or switching. Be sure to use a capacitor with a rated voltage range that includes these irregular voltages.

| Voltage | DV Voltage | DC+AC Voltage | AC Voltage | Pulse Voltage(1) | Pulse Voltage(2) |
|------------------------|------------|---------------|------------|------------------|------------------|
| Positional Measurement | | | | | |

2. Test condition for AC withstanding Voltage

(1) Test Equipment

Tests for AC withstanding voltage should be made with equipment capable of creating a wave similar to a 50/60 Hz sine wave. If the distorted sine wave or overload exceeding the specified voltage value is applied, a defect may be caused.

(2) Voltage applied method

The capacitor's leads or terminals should be firmly connected to the output of the withstanding voltage test equipment, and then the voltage should be raised from near zero to the test voltage. If the test voltage is applied directly to the capacitor without raising it from near zero, it should be applied with the ***zero cross**. At the end of the test time, the test voltage should be reduced to near zero, and then the capacitor's leads or terminals should be taken off the output of the withstanding voltage test equipment. If the test voltage is applied directly to the capacitor without raising it from near zero, surge voltage may occur and cause a defect.

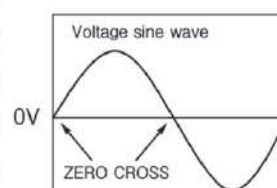

***ZERO CROSS** is the point where voltage sine wave

(3) Dielectric strength testing method

In case of dielectric strength test, the capacitor's is applied between the terminations for 1 to 5 sec., provided the charge/discharge current is less than 50mA.

3. Soldering

If a chip component is heated or cooled abruptly during soldering, it may crack due to the thermal shock. To prevent this, follow our recommendations below for adequate soldering conditions. Carefully perform preheating so that temperature difference(ΔT) between the solder and component surface is in the following range. The smaller the temperatures difference(ΔT) between the solder and component surface is, the smaller the influence on the chip is.

| Soldering Method | Chip Size | |
|--|-------------------------------------|-------------------------------------|
| | 3.2×1.6mm and under | 3.2×2.5mm and over |
| Reflow Method or Soldering Iron Method | $\Delta T \leq 190^{\circ}\text{C}$ | $\Delta T \leq 130^{\circ}\text{C}$ |

SMD Type-High Voltage

SAMWHA CAPACITOR CO., LTD offers a line of MLCC(Multilayer Ceramic Capacitor). These parts are rated at 3kV dc and safety approved and certified to UL (Underwriters Laboratories Inc. ®)

 **ONLINE CERTIFICATIONS DIRECTORY** [OCD Home](#) [Quick Guide](#) [Contact Us](#) [UL.com](#)

NWGQ8.E304146
Information Technology Equipment Including Electrical Business Equipment Certified for Canada - Component



[Page Bottom](#)

Information Technology Equipment Including Electrical Business Equipment Certified for Canada - Component

[See General Information for Information Technology Equipment Including Electrical Business Equipment Certified for Canada - Component](#)

SAMWHA CAPACITOR CO LTD E304146
 124 BUK-RI
 NAMSA-MYEUN
 YONGIN-SHI, KYONGGI-DO 449-880 REPUBLIC OF KOREA

Component Recognition, Model(s) CS45XXYYTTTA302NRE.

 Marking: Company name, model designation and Recognized Component Mark for Canada, .
[Last Updated](#) on 2006-04-28

[Questions?](#) [Notice of Disclaimer](#) [Page Top](#)

Copyright © 2006 Underwriters Laboratories Inc.®

The appearance of a company's name or product in this database does not in itself assure that products so identified have been manufactured under UL's Follow-Up Service. Only those products bearing the UL Mark should be considered to be Listed and covered under UL's Follow-Up Service. Always look for the Mark on the product.

UL permits the reproduction of the material contained in the Online Certification Directory subject to the following conditions: 1. The Guide Information, Designs and/or Listings (files) must be presented in their entirety and in a non-misleading manner, without any manipulation of the data (or drawings). 2. The statement "Reprinted from the Online Certifications Directory with permission from Underwriters Laboratories Inc." must appear adjacent to the extracted material. In addition, the reprinted material must include a copyright notice in the following format: "Copyright © 2006 Underwriters Laboratories Inc.®"

Reliability and Test Conditions(General Type)

| No. | Item | Characteristic | | Test Methods and Conditions | | | | | | | | | | | | | | | | | | | | | | | | | | | | | | | | | | | | | | | | | | | | | |
|--------------------------|---|--|---|---|---|----------|-----|-----|------|------|---------|---------|---------|---------|-------|-------|--------|--------|--------|---------|---------|---------|-------|-------|-------|----------|----------|-------|--------|--------|-----------|-----------|---------|---|------|-------------------|-----------------|------------------|------------|--------------|------------------|------------|-------------|--------------------------|------------|-------------|--------------------------|------------|---------------|
| | | Temperature Compensating Type | High Dielectric Constant Type | | | | | | | | | | | | | | | | | | | | | | | | | | | | | | | | | | | | | | | | | | | | | | |
| 1 | Operating Temperature Range | C0G : -55 to +125°C | X7R : -55 to +125°C X5R : -55 to +85°C Y5V : -30 to +85°C | | | | | | | | | | | | | | | | | | | | | | | | | | | | | | | | | | | | | | | | | | | | | | |
| 2 | Insulation Resistance | More than 10,000MΩ or 500ΩF (Whichever is smaller) | | - Applied the rated voltage for 2 minutes of charging. - The charge/discharge current is less than 50mA. | | | | | | | | | | | | | | | | | | | | | | | | | | | | | | | | | | | | | | | | | | | | | |
| 3 | Dielectric Strength | No defects or abnormalities | | - C0G : The rated voltage × 300% - X7R, X5R, Y5V : * × 250% - Applied between the terminations for 1 to 5 seconds. - The charge/discharge current is less than 50mA. | | | | | | | | | | | | | | | | | | | | | | | | | | | | | | | | | | | | | | | | | | | | | |
| 4 | Capacitance | Within the specified tolerance | | | | | | | | | | | | | | | | | | | | | | | | | | | | | | | | | | | | | | | | | | | | | | | |
| 5 | Dissipation Factor | 30pF Min. : Q ≥ 1,000 (DF ≤ 0.1%) 30pF Max. : Q ≥ 400+20C (DF ≤ 1/(400+20C)) | <table border="1"> <thead> <tr> <th>Char.</th> <th>50V Min.</th> <th>25V</th> <th>16V</th> <th>10V</th> <th>6.3V</th> </tr> </thead> <tbody> <tr> <td>X7R</td> <td>≤ 2.5%/</td> <td>≤ 3%/</td> <td>≤ 3.5%/</td> <td>≤ 5%/</td> <td>≤ 5%/</td> </tr> <tr> <td>X5R</td> <td>* ≤ 5%</td> <td>* ≤ 7%</td> <td>* ≤ 7%</td> <td>* ≤ 10%</td> <td>* ≤ 10%</td> </tr> <tr> <td>Y5V</td> <td>≤ 5%/</td> <td>≤ 7%/</td> <td>≤ 9%</td> <td>≤ 12.5%/</td> <td>≤ 15%</td> </tr> <tr> <td></td> <td>* ≤ 9%</td> <td>* ≤ 9%</td> <td>* ≤ 12.5%</td> <td>* ≤ 15%</td> <td></td> </tr> </tbody> </table> <p>* You can check the specification at the appendix for each product with mark</p> | Char. | 50V Min. | 25V | 16V | 10V | 6.3V | X7R | ≤ 2.5%/ | ≤ 3%/ | ≤ 3.5%/ | ≤ 5%/ | ≤ 5%/ | X5R | * ≤ 5% | * ≤ 7% | * ≤ 7% | * ≤ 10% | * ≤ 10% | Y5V | ≤ 5%/ | ≤ 7%/ | ≤ 9% | ≤ 12.5%/ | ≤ 15% | | * ≤ 9% | * ≤ 9% | * ≤ 12.5% | * ≤ 15% | | <p>The capacitance/Q/D.F. should be measured at 25°C at the frequency and voltage shown in the table.</p> <table border="1"> <thead> <tr> <th>Cap.</th> <th>Testing Frequency</th> <th>Testing Voltage</th> </tr> </thead> <tbody> <tr> <td>C0G (C ≤ 1000pF)</td> <td>1 ± 0.1MHz</td> <td>0.5 to 5Vrms</td> </tr> <tr> <td>C0G (C > 1000pF)</td> <td>1 ± 0.1kHz</td> <td>1 ± 0.2Vrms</td> </tr> <tr> <td>X7R, X5R, Y5V (C ≤ 10μF)</td> <td>1 ± 0.1kHz</td> <td>1 ± 0.2Vrms</td> </tr> <tr> <td>X7R, X5R, Y5V (C > 10μF)</td> <td>120 ± 24Hz</td> <td>0.5 ± 0.1Vrms</td> </tr> </tbody> </table> | Cap. | Testing Frequency | Testing Voltage | C0G (C ≤ 1000pF) | 1 ± 0.1MHz | 0.5 to 5Vrms | C0G (C > 1000pF) | 1 ± 0.1kHz | 1 ± 0.2Vrms | X7R, X5R, Y5V (C ≤ 10μF) | 1 ± 0.1kHz | 1 ± 0.2Vrms | X7R, X5R, Y5V (C > 10μF) | 120 ± 24Hz | 0.5 ± 0.1Vrms |
| Char. | 50V Min. | 25V | 16V | 10V | 6.3V | | | | | | | | | | | | | | | | | | | | | | | | | | | | | | | | | | | | | | | | | | | | |
| X7R | ≤ 2.5%/ | ≤ 3%/ | ≤ 3.5%/ | ≤ 5%/ | ≤ 5%/ | | | | | | | | | | | | | | | | | | | | | | | | | | | | | | | | | | | | | | | | | | | | |
| X5R | * ≤ 5% | * ≤ 7% | * ≤ 7% | * ≤ 10% | * ≤ 10% | | | | | | | | | | | | | | | | | | | | | | | | | | | | | | | | | | | | | | | | | | | | |
| Y5V | ≤ 5%/ | ≤ 7%/ | ≤ 9% | ≤ 12.5%/ | ≤ 15% | | | | | | | | | | | | | | | | | | | | | | | | | | | | | | | | | | | | | | | | | | | | |
| | * ≤ 9% | * ≤ 9% | * ≤ 12.5% | * ≤ 15% | | | | | | | | | | | | | | | | | | | | | | | | | | | | | | | | | | | | | | | | | | | | | |
| Cap. | Testing Frequency | Testing Voltage | | | | | | | | | | | | | | | | | | | | | | | | | | | | | | | | | | | | | | | | | | | | | | | |
| C0G (C ≤ 1000pF) | 1 ± 0.1MHz | 0.5 to 5Vrms | | | | | | | | | | | | | | | | | | | | | | | | | | | | | | | | | | | | | | | | | | | | | | | |
| C0G (C > 1000pF) | 1 ± 0.1kHz | 1 ± 0.2Vrms | | | | | | | | | | | | | | | | | | | | | | | | | | | | | | | | | | | | | | | | | | | | | | | |
| X7R, X5R, Y5V (C ≤ 10μF) | 1 ± 0.1kHz | 1 ± 0.2Vrms | | | | | | | | | | | | | | | | | | | | | | | | | | | | | | | | | | | | | | | | | | | | | | | |
| X7R, X5R, Y5V (C > 10μF) | 120 ± 24Hz | 0.5 ± 0.1Vrms | | | | | | | | | | | | | | | | | | | | | | | | | | | | | | | | | | | | | | | | | | | | | | | |
| 6 | Solderability of Termination | Termination should be covered with more than 75% of new solder | | - Pb-Free Type Solder : 96.5Sn-3Ag-0.5Cu Solder Temperature : 260 ± 5°C Immersion Time : 3 ± 0.1sec - Pre-Heating at 80~120°C for 10~30sec | | | | | | | | | | | | | | | | | | | | | | | | | | | | | | | | | | | | | | | | | | | | | |
| 7 | Resistance to Soldering Heat | Appearance | No marked defect | | - Preheat the capacitor at 120 to 150°C for 1 minute. (Preheating for 3225, 4520, 4532 Step1 : 100°C to 120°C, 1min Step2 : 170°C to 200°C, 1min) Immerse the capacitor in a eutectic solder solution - Soldering Temp. : 260 ± 5°C - Immersion Time : 10 ± 0.5sec - Initial measurement Perform the initial measurement according to Note1 for Class II - Measurement after test Perform the final measurement according to Note2 for Class I and Class II | | | | | | | | | | | | | | | | | | | | | | | | | | | | | | | | | | | | | | | | | | | | |
| | | Capacitance change | Within ± 2.5% or ± 0.25pF (whichever is larger) | X7R, X5R : ≤ ± 7.5% Y5V : ≤ ± 20% | | | | | | | | | | | | | | | | | | | | | | | | | | | | | | | | | | | | | | | | | | | | | |
| | Dissipation Factor (or Q) | 30pF Min. : Q ≥ 1,000 (DF ≤ 0.1%) 30pF Max. : Q ≥ 400+20C (DF ≤ 1/(400+20C)) | <table border="1"> <thead> <tr> <th>Char.</th> <th>50V Min.</th> <th>25V</th> <th>16V</th> <th>10V</th> <th>6.3V</th> </tr> </thead> <tbody> <tr> <td>X7R</td> <td>≤ 2.5%/</td> <td>≤ 3%/</td> <td>≤ 3.5%/</td> <td>≤ 5%/</td> <td>≤ 5%/</td> </tr> <tr> <td>X5R</td> <td>* ≤ 5%</td> <td>* ≤ 7%</td> <td>* ≤ 7%</td> <td>* ≤ 10%</td> <td>* ≤ 10%</td> </tr> <tr> <td>Y5V</td> <td>≤ 5%/</td> <td>≤ 7%/</td> <td>≤ 9%</td> <td>≤ 12.5%/</td> <td>≤ 15%</td> </tr> <tr> <td></td> <td>* ≤ 9%</td> <td>* ≤ 9%</td> <td>* ≤ 12.5%</td> <td>* ≤ 15%</td> <td></td> </tr> </tbody> </table> | Char. | | 50V Min. | 25V | 16V | 10V | 6.3V | X7R | ≤ 2.5%/ | ≤ 3%/ | ≤ 3.5%/ | ≤ 5%/ | ≤ 5%/ | X5R | * ≤ 5% | * ≤ 7% | * ≤ 7% | * ≤ 10% | * ≤ 10% | Y5V | ≤ 5%/ | ≤ 7%/ | ≤ 9% | ≤ 12.5%/ | ≤ 15% | | * ≤ 9% | * ≤ 9% | * ≤ 12.5% | * ≤ 15% | | | | | | | | | | | | | | | | |
| Char. | 50V Min. | 25V | 16V | 10V | 6.3V | | | | | | | | | | | | | | | | | | | | | | | | | | | | | | | | | | | | | | | | | | | | |
| X7R | ≤ 2.5%/ | ≤ 3%/ | ≤ 3.5%/ | ≤ 5%/ | ≤ 5%/ | | | | | | | | | | | | | | | | | | | | | | | | | | | | | | | | | | | | | | | | | | | | |
| X5R | * ≤ 5% | * ≤ 7% | * ≤ 7% | * ≤ 10% | * ≤ 10% | | | | | | | | | | | | | | | | | | | | | | | | | | | | | | | | | | | | | | | | | | | | |
| Y5V | ≤ 5%/ | ≤ 7%/ | ≤ 9% | ≤ 12.5%/ | ≤ 15% | | | | | | | | | | | | | | | | | | | | | | | | | | | | | | | | | | | | | | | | | | | | |
| | * ≤ 9% | * ≤ 9% | * ≤ 12.5% | * ≤ 15% | | | | | | | | | | | | | | | | | | | | | | | | | | | | | | | | | | | | | | | | | | | | | |
| I.R. | More than 10,000MΩ or 500Ω.F (Whichever is smaller) | | | | | | | | | | | | | | | | | | | | | | | | | | | | | | | | | | | | | | | | | | | | | | | | |

SMD Type

| No. | Item | Characteristic | | | | Test Methods and Conditions | | | | | | | | | | | | | | | | | | | | | | | | | | | | | | |
|---------------------------|--|--|--|--|-----------------------------|-----------------------------|---|------|-----|------|------|------|------------|-----------------------------|------------|-----------------------------|------------|------------|----------|----------|--------|----------|----------|--------|--------|-------|--------|----------|----------|--------|----------|----------|--------|--------|--|--|
| | | Temperature Compensating Type | High Dielectric Constant Type | | | | | | | | | | | | | | | | | | | | | | | | | | | | | | | | | |
| 8 | Temperature Cycle | Appearance | No marking defects | | | | Perform the five cycles according to the four heat treatments listed in the following table. <table border="1" style="margin-top: 10px; width: 100%; border-collapse: collapse;"> <thead> <tr> <th>Step</th> <th>1</th> <th>2</th> <th>3</th> <th>4</th> </tr> </thead> <tbody> <tr> <td>Temp. (°C)</td> <td>Min. Operating Temp. +0, -3</td> <td>Room Temp.</td> <td>Max. Operating Temp. +3, -0</td> <td>Room Temp.</td> </tr> <tr> <td>Time (Min)</td> <td>30±3</td> <td>2 to 3</td> <td>30±3</td> <td>2 to 3</td> </tr> </tbody> </table> - Initial measurement Perform the initial measurement according to Note1 for Class II - Measurement after test Perform the final measurement according to Note2 for Class I and Class II | Step | 1 | 2 | 3 | 4 | Temp. (°C) | Min. Operating Temp. +0, -3 | Room Temp. | Max. Operating Temp. +3, -0 | Room Temp. | Time (Min) | 30±3 | 2 to 3 | 30±3 | 2 to 3 | | | | | | | | | | | | | | |
| | | Step | 1 | 2 | 3 | 4 | | | | | | | | | | | | | | | | | | | | | | | | | | | | | | |
| | | Temp. (°C) | Min. Operating Temp. +0, -3 | Room Temp. | Max. Operating Temp. +3, -0 | Room Temp. | | | | | | | | | | | | | | | | | | | | | | | | | | | | | | |
| | | Time (Min) | 30±3 | 2 to 3 | 30±3 | 2 to 3 | | | | | | | | | | | | | | | | | | | | | | | | | | | | | | |
| Capacitance Change | Within ±2.5% or ±0.25pF (whichever is larger) | X7R, X5R : Within ±7.5% Y5V : Within ±20% | | | | | | | | | | | | | | | | | | | | | | | | | | | | | | | | | | |
| Dissipation Factor (or Q) | 30pF Min. : Q ≥ 1,000 (DF ≤ 0.1%) 30pF Max. : Q ≥ 400+20C (DF ≤ 1/(400+20C)) | <table border="1" style="width: 100%; border-collapse: collapse;"> <thead> <tr> <th>Char.</th> <th>50V Min.</th> <th>25V</th> <th>16V</th> <th>10V</th> <th>6.3V</th> </tr> </thead> <tbody> <tr> <td>X7R</td> <td>≤5%/</td> <td>≤5%/</td> <td>≤5%/</td> <td>≤7.5%/</td> <td>≤7.5%/</td> </tr> <tr> <td>X5R</td> <td>* ≤7.5%</td> <td>* ≤10%</td> <td>* ≤10%</td> <td>* ≤12.5%</td> <td>* ≤12.5%</td> </tr> <tr> <td>Y5V</td> <td>≤7.5%/</td> <td>≤10%/</td> <td>≤12.5%</td> <td>≤15%/</td> <td>≤20%</td> </tr> <tr> <td></td> <td>* ≤12.5%</td> <td>* ≤12.5%</td> <td>* ≤15%</td> <td>* ≤20%</td> <td></td> </tr> </tbody> </table> | Char. | 50V Min. | 25V | 16V | 10V | 6.3V | X7R | ≤5%/ | ≤5%/ | ≤5%/ | ≤7.5%/ | ≤7.5%/ | X5R | * ≤7.5% | * ≤10% | * ≤10% | * ≤12.5% | * ≤12.5% | Y5V | ≤7.5%/ | ≤10%/ | ≤12.5% | ≤15%/ | ≤20% | | * ≤12.5% | * ≤12.5% | * ≤15% | * ≤20% | | | | | |
| Char. | 50V Min. | 25V | 16V | 10V | 6.3V | | | | | | | | | | | | | | | | | | | | | | | | | | | | | | | |
| X7R | ≤5%/ | ≤5%/ | ≤5%/ | ≤7.5%/ | ≤7.5%/ | | | | | | | | | | | | | | | | | | | | | | | | | | | | | | | |
| X5R | * ≤7.5% | * ≤10% | * ≤10% | * ≤12.5% | * ≤12.5% | | | | | | | | | | | | | | | | | | | | | | | | | | | | | | | |
| Y5V | ≤7.5%/ | ≤10%/ | ≤12.5% | ≤15%/ | ≤20% | | | | | | | | | | | | | | | | | | | | | | | | | | | | | | | |
| | * ≤12.5% | * ≤12.5% | * ≤15% | * ≤20% | | | | | | | | | | | | | | | | | | | | | | | | | | | | | | | | |
| I.R. | More than 10,000MΩ or 500Ω.F (Whichever is smaller) | | | | | | | | | | | | | | | | | | | | | | | | | | | | | | | | | | | |
| 9 | Humidity Load | Appearance | No marking defects | | | | - Temperature : 40±2°C - Humidity : 90~95% - Hour : 500±12hrs - Test Voltage : The rated voltage - Initial measurement Perform the initial measurement according to Note1 for Class II - Measurement after test Perform the final measurement according to Note2 for Class I and Class II | | | | | | | | | | | | | | | | | | | | | | | | | | | | | |
| | | Capacitance Change | Within ±7.5% or ±0.75pF (whichever is larger) | X7R, X5R : Within ±12.5% Y5V : Within +30%, -40% (Y5V/1.0μF, 2.2μF, 4.7μF/10V) Within ±30% (others) | | | | | | | | | | | | | | | | | | | | | | | | | | | | | | | | |
| | | Dissipation Factor (or Q) | 30pF Min. : Q ≥ 200 (DF ≤ 0.5%) 30pF Max. : Q ≥ 100 +10/3C (DF ≤ 1/(100+10/3C)) | <table border="1" style="width: 100%; border-collapse: collapse;"> <thead> <tr> <th>Char.</th> <th>50V Min.</th> <th>25V</th> <th>16V</th> <th>10V</th> <th>6.3V</th> </tr> </thead> <tbody> <tr> <td>X7R</td> <td>≤5%/</td> <td>≤5%/</td> <td>≤5%/</td> <td>≤7.5%/</td> <td>≤7.5%/</td> </tr> <tr> <td>X5R</td> <td>* ≤7.5%</td> <td>* ≤10%</td> <td>* ≤10%</td> <td>* ≤12.5%</td> <td>* ≤12.5%</td> </tr> <tr> <td>Y5V</td> <td>≤7.5%/</td> <td>≤10%/</td> <td>≤12.5%</td> <td>≤15%/</td> <td>≤20%</td> </tr> <tr> <td></td> <td>* ≤12.5%</td> <td>* ≤12.5%</td> <td>* ≤15%</td> <td>* ≤20%</td> <td></td> </tr> </tbody> </table> | Char. | 50V Min. | | 25V | 16V | 10V | 6.3V | X7R | ≤5%/ | ≤5%/ | ≤5%/ | ≤7.5%/ | ≤7.5%/ | X5R | * ≤7.5% | * ≤10% | * ≤10% | * ≤12.5% | * ≤12.5% | Y5V | ≤7.5%/ | ≤10%/ | ≤12.5% | ≤15%/ | ≤20% | | * ≤12.5% | * ≤12.5% | * ≤15% | * ≤20% | | |
| | | Char. | 50V Min. | 25V | 16V | 10V | | 6.3V | | | | | | | | | | | | | | | | | | | | | | | | | | | | |
| X7R | ≤5%/ | ≤5%/ | ≤5%/ | ≤7.5%/ | ≤7.5%/ | | | | | | | | | | | | | | | | | | | | | | | | | | | | | | | |
| X5R | * ≤7.5% | * ≤10% | * ≤10% | * ≤12.5% | * ≤12.5% | | | | | | | | | | | | | | | | | | | | | | | | | | | | | | | |
| Y5V | ≤7.5%/ | ≤10%/ | ≤12.5% | ≤15%/ | ≤20% | | | | | | | | | | | | | | | | | | | | | | | | | | | | | | | |
| | * ≤12.5% | * ≤12.5% | * ≤15% | * ≤20% | | | | | | | | | | | | | | | | | | | | | | | | | | | | | | | | |
| I.R. | More than 500MΩ or 25Ω.F (Whichever is smaller) | | | | | | | | | | | | | | | | | | | | | | | | | | | | | | | | | | | |
| 10 | High Temperature Load | Appearance | No marking defects | | | | - Testing time : 1000±12hrs - Applied voltage : Rated voltage < DC250V : ×200% - Temperature : C0G, X7R → 125±3°C X5R, Y5V → 85±3°C - Initial measurement Perform the initial measurement according to Note1 for Class II - Measurement after test Perform the final measurement according to Note2 for Class I and Class II | | | | | | | | | | | | | | | | | | | | | | | | | | | | | |
| | | Capacitance Change | Within ±3% or ±0.3pF (whichever is larger) | X7R, X5R : Within ±12.5% Y5V : Within ±30% (Cap. < 1.0μF) Within +30%, -40% (Cap. ≥ 1.0μF) | | | | | | | | | | | | | | | | | | | | | | | | | | | | | | | | |
| | | Dissipation Factor (or Q) | 30pF Min. : Q ≥ 350 (DF ≤ 0.3%) 10pF ≤ Cp ≤ 30pF : Q ≥ 275 +5/2C (DF ≤ 1/(275+5/2C)) 10pF Max. : Q ≥ 200+10C (DF ≤ 1/(200+10C)) | <table border="1" style="width: 100%; border-collapse: collapse;"> <thead> <tr> <th>Char.</th> <th>50V Min.</th> <th>25V</th> <th>16V</th> <th>10V</th> <th>6.3V</th> </tr> </thead> <tbody> <tr> <td>X7R</td> <td>≤5%/</td> <td>≤5%/</td> <td>≤5%/</td> <td>≤7.5%/</td> <td>≤7.5%/</td> </tr> <tr> <td>X5R</td> <td>* ≤7.5%</td> <td>* ≤10%</td> <td>* ≤10%</td> <td>* ≤12.5%</td> <td>* ≤12.5%</td> </tr> <tr> <td>Y5V</td> <td>≤7.5%/</td> <td>≤10%/</td> <td>≤12.5%</td> <td>≤15%/</td> <td>≤20%</td> </tr> <tr> <td></td> <td>* ≤12.5%</td> <td>* ≤12.5%</td> <td>* ≤15%</td> <td>* ≤20%</td> <td></td> </tr> </tbody> </table> | Char. | 50V Min. | | 25V | 16V | 10V | 6.3V | X7R | ≤5%/ | ≤5%/ | ≤5%/ | ≤7.5%/ | ≤7.5%/ | X5R | * ≤7.5% | * ≤10% | * ≤10% | * ≤12.5% | * ≤12.5% | Y5V | ≤7.5%/ | ≤10%/ | ≤12.5% | ≤15%/ | ≤20% | | * ≤12.5% | * ≤12.5% | * ≤15% | * ≤20% | | |
| | | Char. | 50V Min. | 25V | 16V | 10V | | 6.3V | | | | | | | | | | | | | | | | | | | | | | | | | | | | |
| X7R | ≤5%/ | ≤5%/ | ≤5%/ | ≤7.5%/ | ≤7.5%/ | | | | | | | | | | | | | | | | | | | | | | | | | | | | | | | |
| X5R | * ≤7.5% | * ≤10% | * ≤10% | * ≤12.5% | * ≤12.5% | | | | | | | | | | | | | | | | | | | | | | | | | | | | | | | |
| Y5V | ≤7.5%/ | ≤10%/ | ≤12.5% | ≤15%/ | ≤20% | | | | | | | | | | | | | | | | | | | | | | | | | | | | | | | |
| | * ≤12.5% | * ≤12.5% | * ≤15% | * ≤20% | | | | | | | | | | | | | | | | | | | | | | | | | | | | | | | | |
| I.R. | More than 1,000MΩ or 50Ω.F (Whichever & Smaller) | | | | | | | | | | | | | | | | | | | | | | | | | | | | | | | | | | | |

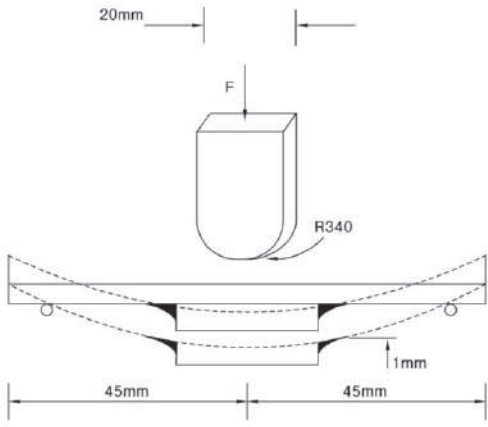
| No. | Item | Characteristic | | Test Methods and Conditions | | | | | | | | | | | | | | | | | | | | | | | | | |
|-------|---|--|--|---|--|-------|----------|------|-----|-----|------|-----|----------------|---------------|----------------|-------------------|-------------------|-----|----------------|---------------|----------------|-------------------|-------------------|-----|-------------------|------------------|------------------|------------------|------|
| | | Temperature Compensating Type | High Dielectric Constant Type | | | | | | | | | | | | | | | | | | | | | | | | | | |
| 11 | Bending Strength |  <p>No cracking or marking defects shall occur</p> | | - Substrate Material : Glass EPOXY Board - Board Thickness : 1.6mm 0.8mm(0603/1005size) ※ Test Condition - Bending Limit : 1mm - Pressurizing Speed : 1mm/sec - Holding Time: 5±1 sec | | | | | | | | | | | | | | | | | | | | | | | | | |
| | | Capacitance Change | Within ±5% or ±0.5pF (whichever is larger) X7R, X5R : Within ±12.5% Y5V : Within ±30% | | | | | | | | | | | | | | | | | | | | | | | | | | |
| 12 | Vibration Resistance | Appearance | No defects or abnormalities | | * After soldering and then let sit for 24hr+4hr (temperature compensating type), 24hr+4hr(high dielectric constant type) at room temperature. The capacitor should be subjected to a simple harmonic motion having a total amplitude of 1.5mm, the frequency being varied uniformly between the approximate limits of 10 and 55Hz, shall be traversed(from 10Hz to 55Hz then 10Hz again) in approximately 1 minute. This motion shall be applied for a period of 2 hours in each 3 mutually perpendicular directions(total is 6hours). | | | | | | | | | | | | | | | | | | | | | | | | |
| | | Capacitance | Whin the specified tolerance | | | | | | | | | | | | | | | | | | | | | | | | | | |
| | | Q/DF | 30pF Min. : Q 1,000 (DF 0.1%) 30pF Max. : Q 400+20C (DF 1/ (400+20C)) | <table border="1"> <thead> <tr> <th>Char.</th> <th>50V Min.</th> <th>25V</th> <th>16V</th> <th>10V</th> <th>6.3V</th> </tr> </thead> <tbody> <tr> <td>X7R</td> <td>≤2.5%/ *≤5%</td> <td>≤3%/ *≤7%</td> <td>≤3.5%/ *≤7%</td> <td>≤5%/ *≤10%</td> <td>≤5%/ *≤10%</td> </tr> <tr> <td>X5R</td> <td>≤2.5%/ *≤5%</td> <td>≤3%/ *≤7%</td> <td>≤3.5%/ *≤7%</td> <td>≤5%/ *≤10%</td> <td>≤5%/ *≤10%</td> </tr> <tr> <td>Y5V</td> <td>≤5%/ *≤9%</td> <td>≤7%/ *≤9%</td> <td>≤9%/ *≤12.5%</td> <td>≤12.5%/ *≤15%</td> <td>≤15%</td> </tr> </tbody> </table> | | Char. | 50V Min. | 25V | 16V | 10V | 6.3V | X7R | ≤2.5%/ *≤5% | ≤3%/ *≤7% | ≤3.5%/ *≤7% | ≤5%/ *≤10% | ≤5%/ *≤10% | X5R | ≤2.5%/ *≤5% | ≤3%/ *≤7% | ≤3.5%/ *≤7% | ≤5%/ *≤10% | ≤5%/ *≤10% | Y5V | ≤5%/ *≤9% | ≤7%/ *≤9% | ≤9%/ *≤12.5% | ≤12.5%/ *≤15% | ≤15% |
| Char. | 50V Min. | 25V | 16V | 10V | 6.3V | | | | | | | | | | | | | | | | | | | | | | | | |
| X7R | ≤2.5%/ *≤5% | ≤3%/ *≤7% | ≤3.5%/ *≤7% | ≤5%/ *≤10% | ≤5%/ *≤10% | | | | | | | | | | | | | | | | | | | | | | | | |
| X5R | ≤2.5%/ *≤5% | ≤3%/ *≤7% | ≤3.5%/ *≤7% | ≤5%/ *≤10% | ≤5%/ *≤10% | | | | | | | | | | | | | | | | | | | | | | | | |
| Y5V | ≤5%/ *≤9% | ≤7%/ *≤9% | ≤9%/ *≤12.5% | ≤12.5%/ *≤15% | ≤15% | | | | | | | | | | | | | | | | | | | | | | | | |
| 13 | Humidity Steady State | Appearance | No marking defects | | - Temperature : 40±2°C - Humidity : 90~95% - Hour : 500±12hours - Initial measurement Perform the initial measurement according to Note1 for Class II - Measurement after test Perform the final measurement according to Note2 for Class I and Class II | | | | | | | | | | | | | | | | | | | | | | | | |
| | | Capacitance Change | Within ±5% or ±0.5pF (whichever is larger) | X7R, X5R : Within ±12.5% Y5V : Within ±30% | | | | | | | | | | | | | | | | | | | | | | | | | |
| | | Dissipation (or Q) | 30pF Min. : Q ≥350 (DF ≤0.3%) 10pF ≤ Cp ≤ 30pF : Q ≥275 +5/2C (DF ≤1/(275+5/2C)) 10pF Max. : Q ≥200+10C (DF ≤1/(200+10C)) | <table border="1"> <thead> <tr> <th>Char.</th> <th>50V Min.</th> <th>25V</th> <th>16V</th> <th>10V</th> <th>6.3V</th> </tr> </thead> <tbody> <tr> <td>X7R</td> <td>≤5%/ *≤7.5%</td> <td>≤5%/ *≤10%</td> <td>≤5%/ *≤10%</td> <td>≤7.5%/ *≤12.5%</td> <td>≤7.5%/ *≤12.5%</td> </tr> <tr> <td>X5R</td> <td>≤5%/ *≤7.5%</td> <td>≤5%/ *≤10%</td> <td>≤5%/ *≤10%</td> <td>≤7.5%/ *≤12.5%</td> <td>≤7.5%/ *≤12.5%</td> </tr> <tr> <td>Y5V</td> <td>≤7.5%/ *≤12.5%</td> <td>≤10%/ *≤12.5%</td> <td>≤12.5%/ *≤15%</td> <td>≤15%/ *≤20%</td> <td>≤20%</td> </tr> </tbody> </table> | | Char. | 50V Min. | 25V | 16V | 10V | 6.3V | X7R | ≤5%/ *≤7.5% | ≤5%/ *≤10% | ≤5%/ *≤10% | ≤7.5%/ *≤12.5% | ≤7.5%/ *≤12.5% | X5R | ≤5%/ *≤7.5% | ≤5%/ *≤10% | ≤5%/ *≤10% | ≤7.5%/ *≤12.5% | ≤7.5%/ *≤12.5% | Y5V | ≤7.5%/ *≤12.5% | ≤10%/ *≤12.5% | ≤12.5%/ *≤15% | ≤15%/ *≤20% | ≤20% |
| | | Char. | 50V Min. | 25V | | 16V | 10V | 6.3V | | | | | | | | | | | | | | | | | | | | | |
| X7R | ≤5%/ *≤7.5% | ≤5%/ *≤10% | ≤5%/ *≤10% | ≤7.5%/ *≤12.5% | ≤7.5%/ *≤12.5% | | | | | | | | | | | | | | | | | | | | | | | | |
| X5R | ≤5%/ *≤7.5% | ≤5%/ *≤10% | ≤5%/ *≤10% | ≤7.5%/ *≤12.5% | ≤7.5%/ *≤12.5% | | | | | | | | | | | | | | | | | | | | | | | | |
| Y5V | ≤7.5%/ *≤12.5% | ≤10%/ *≤12.5% | ≤12.5%/ *≤15% | ≤15%/ *≤20% | ≤20% | | | | | | | | | | | | | | | | | | | | | | | | |
| I.R | More than 1,000MΩ or 50Ω.F (Whichever is Smaller) | | | | | | | | | | | | | | | | | | | | | | | | | | | | |

SMD Type

| No. | Item | | Characteristic | | | | Test Methods and Conditions | | | | | | | | | | | | | | | | | | | | | | | | | | |
|-------|--|---|-------------------------------|-----------------|--|---|-----------------------------|-------------|-----------------|-------------|-----|---------------|------|-------------|-----|--------------|-------------|-----|--------------|--------------------|--|------|-----------------|---|------|---|-------|---|------|---|----------------|---|------|
| | | | Temperature Compensating Type | | High Dielectric Constant Type | | | | | | | | | | | | | | | | | | | | | | | | | | | | |
| 14 | Capacitance Temperature Change Characteristics | Capacitance Change | | | <table border="1" style="width: 100%; border-collapse: collapse;"> <thead> <tr> <th>Char.</th> <th>Temp. Range</th> <th>Reference Temp.</th> <th>Cap. Change</th> </tr> </thead> <tbody> <tr> <td>X7R</td> <td>-55 to +125°C</td> <td rowspan="3" style="text-align: center;">25°C</td> <td>Within ±15%</td> </tr> <tr> <td>X5R</td> <td>-55 to +85°C</td> <td>Within ±15%</td> </tr> <tr> <td>Y5V</td> <td>-30 to +85°C</td> <td>Within 22% -82%</td> </tr> </tbody> </table> | | Char. | Temp. Range | Reference Temp. | Cap. Change | X7R | -55 to +125°C | 25°C | Within ±15% | X5R | -55 to +85°C | Within ±15% | Y5V | -30 to +85°C | Within 22% -82% | <p>(1) Temperature Compensating Type: The temperature coefficient is determined using the capacitance measured in step 3 as a reference, When cycling the temperature sequentially from step 1 through 5, (C0G: +25 to 125°C) the capacitance shall be with in the specified tolerance for the temperature coefficient. The capacitance drift is calculated by dividing the difference between the maximum measured values in the step 1, 3 and 5 by the Cap. value in step 3</p> <table border="1" style="width: 100%; border-collapse: collapse;"> <thead> <tr> <th>Step</th> <th>Temperature(°C)</th> </tr> </thead> <tbody> <tr> <td>1</td> <td>25±2</td> </tr> <tr> <td>2</td> <td>-55±3</td> </tr> <tr> <td>3</td> <td>25±2</td> </tr> <tr> <td>4</td> <td>125±3(for C0G)</td> </tr> <tr> <td>5</td> <td>25±2</td> </tr> </tbody> </table> <p>(2) High Dielectric Constant Type : The ranges of capacitance change compared with the 25°C value over the temperature range shown in the table shall be in the specified range.</p> | Step | Temperature(°C) | 1 | 25±2 | 2 | -55±3 | 3 | 25±2 | 4 | 125±3(for C0G) | 5 | 25±2 |
| | | Char. | Temp. Range | Reference Temp. | Cap. Change | | | | | | | | | | | | | | | | | | | | | | | | | | | | |
| X7R | -55 to +125°C | 25°C | Within ±15% | | | | | | | | | | | | | | | | | | | | | | | | | | | | | | |
| X5R | -55 to +85°C | | Within ±15% | | | | | | | | | | | | | | | | | | | | | | | | | | | | | | |
| Y5V | -30 to +85°C | | Within 22% -82% | | | | | | | | | | | | | | | | | | | | | | | | | | | | | | |
| Step | Temperature(°C) | | | | | | | | | | | | | | | | | | | | | | | | | | | | | | | | |
| 1 | 25±2 | | | | | | | | | | | | | | | | | | | | | | | | | | | | | | | | |
| 2 | -55±3 | | | | | | | | | | | | | | | | | | | | | | | | | | | | | | | | |
| 3 | 25±2 | | | | | | | | | | | | | | | | | | | | | | | | | | | | | | | | |
| 4 | 125±3(for C0G) | | | | | | | | | | | | | | | | | | | | | | | | | | | | | | | | |
| 5 | 25±2 | | | | | | | | | | | | | | | | | | | | | | | | | | | | | | | | |
| | Temperature Coefficient | <table border="1" style="width: 100%; border-collapse: collapse;"> <thead> <tr> <th>Char.</th> <th>Temp. Range</th> <th>Temperature Coefficient</th> </tr> </thead> <tbody> <tr> <td>C0G</td> <td>-55 to +125°C</td> <td>±30ppm/°C</td> </tr> </tbody> </table> | Char. | Temp. Range | Temperature Coefficient | C0G | -55 to +125°C | ±30ppm/°C | | | | | | | | | | | | | | | | | | | | | | | | | |
| Char. | Temp. Range | Temperature Coefficient | | | | | | | | | | | | | | | | | | | | | | | | | | | | | | | |
| C0G | -55 to +125°C | ±30ppm/°C | | | | | | | | | | | | | | | | | | | | | | | | | | | | | | | |
| 15 | Preservation(keeping) | ※ When solderability is considered, capacitors are recommended to be used in 12 months | | | | <p>(1) Temperature : 25°C ±10°C</p> <p>(2) Relative Humidity : Below 70% RH</p> | | | | | | | | | | | | | | | | | | | | | | | | | | | |
| 16 | The regulation of environmental pollution materials. | ※ Never use materials mentioned below in MLCC products regulated this document. Pb, Cd, Hg, Cr ⁺⁶ , PBB(polybrominated biphenyl), PBDE(polybrominated diphenyl ethers), asbestos. | | | | | | | | | | | | | | | | | | | | | | | | | | | | | | | |

- In case of high Voltage and thin layer type Capacitor, it can be different from nomal specification.
So Please ask to our sales person.

- Note1. Initial Measurement for Class II

Perform a heart tertment at 150+0, -10°C for one hour and then let sit for 24±2 hours at room temperature, then measure

- Note2. Measurement after test

1. Class I

Let sit for 24±2 hours at room temperature, then measurement

2. Class II

Perform a heart treatment at 150±0, -10°C for one hour and then let sit for 24±2 hours at room temperature, then measure

SMD Type - High Frequency Capacitors

SAMWHA high frequency MLCC(CF) products offers excellent performance in demanding high RF power applications requiring consistent and reliable operation .

The copper electrodes allow for Ultra -low ESR and high Q in the GHz frequencies.

The CF series products are your best choice for high RF power applications from UHF through microwave frequencies.

Applications

- RF Power Amplifiers, Low Noise Amplifiers
- Filter Networks
- Cable TV and telecommunication networks
- GPS, Bluetooth and TV set-top boxes
- MRI Systems

Features

- Ultra Low ESR
- High Q
- High Self Resonance
- Capacitance Range : 0.5pF to 100pF
- Temperature characteristics : COG

How to Order(Product Identification)

CF 2012 COG 101 J 251 N R B

1 2 3 4 5 6 7 8 9

1 CF : High Frequency(SMD)

2 Size Code

This is expressed in tens of a millimeter.

The first two digits are the length, The last two digits are width.

SMD Type - High Frequency Capacitors

3 Temperature Coefficient Code

| Classification | Code | Temperature Range | Temperature Coefficient |
|----------------|------|-------------------|-------------------------|
| Class I | C0G | -55 to +125°C | ±30 ppm/°C |

4 Capacitance Code(Pico farads)

The nominal capacitance value in pF is expressed by three digit numbers.

The first two digits represents significant figures and the last digit denotes the number of zero

Ex.) 104 = 100000pF R denotes decimal 8R2 = 8.2pF

5 Capacitance Tolerance Code

| Code | Tolerance | Code | Tolerance |
|------|-----------|------|-----------|
| B | ±0.1pF | G | ±2.0% |
| C | ±0.25pF | J | ±5% |
| D | ±0.5pF | K | ±10% |
| F | ±1.0% | M | ±20% |

6 Voltage Code

| Code | 250 | 500 | 101 | 201 | 251 |
|---------------|--------|--------|---------|---------|---------|
| Rated Voltage | DC 25V | DC 50V | DC 100V | DC 200V | DC 250V |

7 Termination Code

N : Nickel-Tin Plate

8 Packing Code

R : Reel Type, B : Bulk Type

9 Thickness Option

| Size(mm) | Thickness(mm) | | Code | Size(mm) | Thickness(mm) | | Code |
|-----------|---------------|--------|------|----------------|---------------|--------|------|
| | t | Tol(±) | | | t | Tol(±) | |
| 0603/1005 | 0.3 | 0.03 | - | 3216 | 1.15 | 0.15 | E |
| 1005 | 0.5 | 0.05 | - | 3216/3225 | 1.6 | 0.2 | I |
| 2012 | 0.6 | 0.1 | A | 3225 | 1.8 | 0.2 | J |
| 1608 | 0.8 | 0.1 | B | 3225/4532/5750 | 2 | 0.25 | K |
| 2012/3216 | 0.85 | 0.15 | B | 3225/4532/5750 | 2.5 | 0.25 | L |
| 2012 | 1.25 | 0.15 | E | | | | |

| Size(mm) | Code | Packaging | Size(mm) | Code | Packaging |
|-----------|------|-----------------|----------------|------|-----------------|
| 0603/1005 | - | Paper Taping | 3216 | E | Embossed Taping |
| 1005 | - | Paper Taping | 3216/3225 | I | Embossed Taping |
| 2012 | A | Paper Taping | 3225 | J | Embossed Taping |
| 1608 | B | Paper Taping | 3225/4532/5750 | K | Embossed Taping |
| 2012/3216 | B | Paper Taping | 3225/4532/5750 | L | Embossed Taping |
| 2012 | E | Embossed Taping | | | |

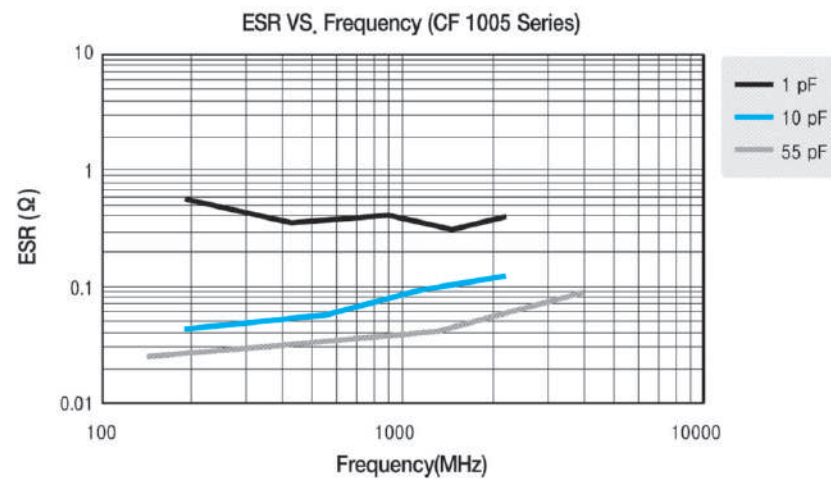
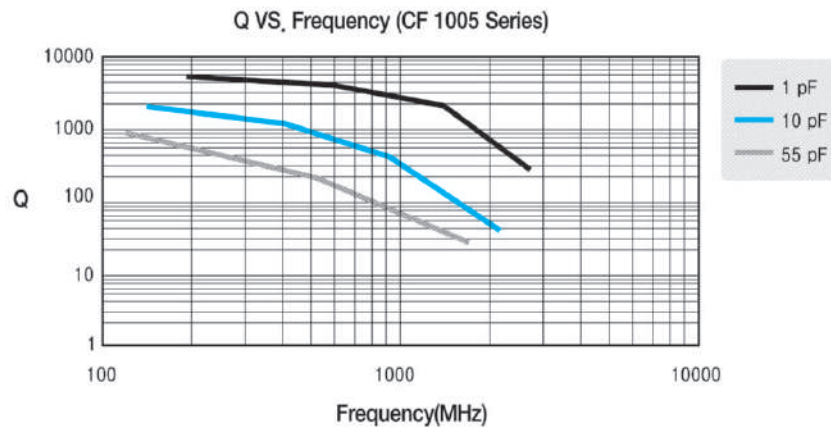

Appendix I

COG-Temperature Compensating Type(0603~2012)

| Type Size(inch) Volt(V) Cap. | COG | | | | | |
|---------------------------------------|------------|----|------------|-----|------------|-----|
| | 1005(0402) | | 1608(0603) | | 2012(0805) | |
| | 25 | 50 | 50 | 100 | 50 | 100 |
| 0.5pF(0R5) | | | | | | |
| 1pF(010) | | | | | | |
| 2pF(020) | | | | | | |
| 3pF(030) | | | | | | |
| 4pF(040) | | | | | | |
| 5pF(050) | | | | | | |
| 6pF(060) | | | | | | |
| 7pF(070) | | | | | | |
| 8pF(080) | | | | | | |
| 9pF(090) | | | | | | |
| 10pF(100) | | | | | | |
| 12pF(120) | | | | | | |
| 15pF(150) | | | | | | |
| 18pF(180) | | | | | | |
| 22pF(220) | | | | | | |
| 27pF(270) | | | | | | |
| 33pF(330) | | | | | | |
| 39pF(390) | | | | | | |
| 47pF(470) | | | | | | |
| 56pF(560) | | | | | | |
| 68pF(680) | | | | | | |
| 82pF(820) | | | | | | |
| 100pF(101) | | | | | | |

Automotive Applications

Features

- SAMWHA Series meet AEC-Q200 requirements
- SAMWHA Series Certify IATF 16949(ISO/TS 16949), ISO 9001, ISO 14001
- SAMWHA Series are RoHS Compliant

Applications

- Automotive electronic equipment

How to Order(Product Identification)

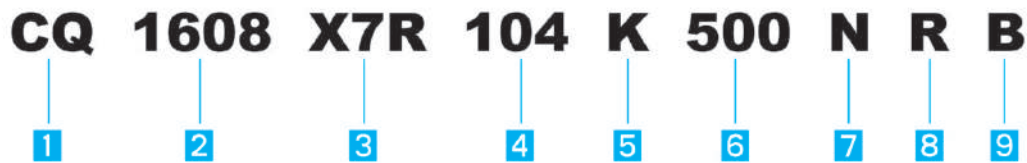

1 Monolithic Multilayer Ceramic Capacitor Leadless Type for Automotive Application

2 Size Code

This is expressed in tens of a millimeter.
The first two digits are the length, The last two digits are width.

3 Temperature Coefficient Code

| Classification | Code | Temperature Range | Capacitance Change or Temperature Coefficient |
|----------------|------|-------------------|---|
| Class I | C0G | -55 to +125°C | ±30 ppm/°C |
| Class II | X7R | -55 to +125°C | ±15% |
| Class II | X8R | -55 to +150°C | ±15% |

4 Capacitance Code(Pico farads)

The nominal capacitance value in pF is expressed by three digit numbers.
The first two digits represents significant figures and the last digit denotes the number of zero
Ex.) 104 = 100000pF

R denotes decimal

8R2 = 8.2pF

5 Capacitance Tolerance Code

| Code | Tolerance | Code | Tolerance |
|------|-----------|------|-----------|
| B | ±0.1pF | G | ±2.0% |
| C | ±0.25pF | J | ±5% |
| D | ±0.5pF | K | ±10% |
| F | ±1.0% | M | ±20% |

6 Voltage Code

| Code | 6R3 | 100 | 160 | 250 | 500 | 101 | 201 | 251 | 501 | 631 | 102 | 202 | 302 |
|---------------|---------|--------|--------|--------|--------|---------|---------|---------|---------|---------|--------|--------|--------|
| Rated Voltage | DC 6.3V | DC 10V | DC 16V | DC 25V | DC 50V | DC 100V | DC 200V | DC 250V | DC 500V | DC 630V | DC 1KV | DC 2KV | DC 3KV |

7 Termination & Design Code

N : Nickel-Tin Plate A : Nickel-Tin Plate(Soft Termination) O : Open Mode F : Floating electrode
 S : Ag/Ni-SN(Ag Epoxy/Nickel-Tin Plate)+Open mode type

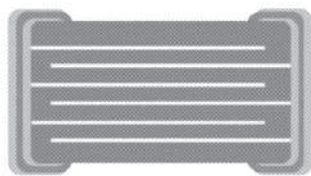

Normal Type

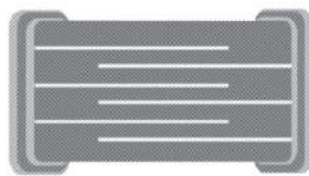

Open Mode Type

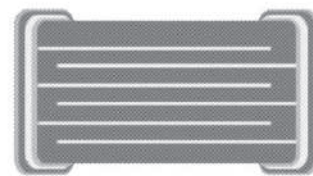

Soft Termination Type

8 Packing Code

R : Reel Type, B : Bulk Type

9 Thickness Option

| Size(mm) | Thickness(mm) | | Code | Size(mm) | Thickness(mm) | | Code |
|-----------|---------------|--------|------|----------------|---------------|--------|------|
| | t | Tol(±) | | | t | Tol(±) | |
| 0603/1005 | 0.3 | 0.03 | - | 3216 | 1.15 | 0.15 | E |
| 1005 | 0.5 | 0.05 | - | 3216/3225 | 1.6 | 0.2 | I |
| 2012 | 0.6 | 0.1 | A | 3225 | 1.8 | 0.2 | J |
| 1608 | 0.8 | 0.1 | B | 3225/4532/5750 | 2 | 0.25 | K |
| 2012/3216 | 0.85 | 0.15 | B | 3225/4532/5750 | 2.5 | 0.25 | L |
| 2012 | 1.25 | 0.15 | E | | | | |

| Size(mm) | Code | Packaging | Size(mm) | Code | Packaging |
|-----------|------|-----------------|----------------|------|-----------------|
| 0603/1005 | - | Paper Taping | 3216 | E | Embossed Taping |
| 1005 | - | Paper Taping | 3216/3225 | I | Embossed Taping |
| 2012 | A | Paper Taping | 3225 | J | Embossed Taping |
| 1608 | B | Paper Taping | 3225/4532/5750 | K | Embossed Taping |
| 2012/3216 | B | Paper Taping | 3225/4532/5750 | L | Embossed Taping |
| 2012 | E | Embossed Taping | | | |

Temperature Characteristics See Page 39 (No.21)

Automotive Applications

Dimensions

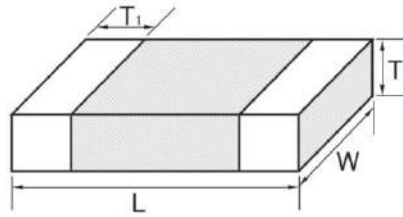

| Code | Dimensions | | | | T1(min) |
|------------|------------|--------|-------|--------|---------|
| | Length | | Width | | |
| | L | Tol(±) | W | Tol(±) | |
| 1005(0402) | 1.00 | 0.05 | 0.50 | 0.05 | 0.05 |
| 1608(0603) | 1.60 | 0.15 | 0.80 | 0.10 | 0.10 |
| 2012(0805) | 2.00 | 0.20 | 1.25 | 0.15 | 0.10 |
| 3216(1206) | 3.20 | 0.30 | 1.60 | 0.20 | 0.15 |
| 3225(1210) | 3.20 | 0.40 | 2.50 | 0.25 | 0.15 |

Construction of Termination

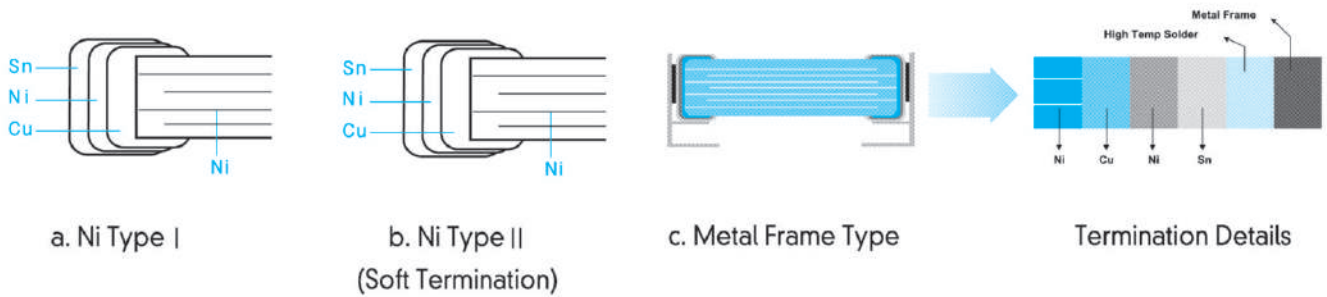

Capacitance Table.

Class I (C0G)

| Size Code (EIA Code) | 1005(0402) | | | | 1608(0603) | | | | 2012(0805) | | | | 3216(1206) | | | | 3225(1210) | | | |
|-------------------------|------------|----|----|-----|------------|----|----|-----|------------|----|----|-----|------------|----|----|-----|------------|----|----|-----|
| | 16 | 25 | 50 | 100 | 16 | 25 | 50 | 100 | 16 | 25 | 50 | 100 | 16 | 25 | 50 | 100 | 16 | 25 | 50 | 100 |
| Rated Volt.(V) | | | | | | | | | | | | | | | | | | | | |
| Cap. | | | | | | | | | | | | | | | | | | | | |
| 0.5pF(0R5) | | | | | | | | | | | | | | | | | | | | |
| 1pF(010) | | | | | | | | | | | | | | | | | | | | |
| 2.2pF(2R2) | | | | | | | | | | | | | | | | | | | | |
| 3pF(030) | | | | | | | | | | | | | | | | | | | | |
| 4pF(040) | | | | | | | | | | | | | | | | | | | | |
| 4.7pF(4R7) | | | | | | | | | | | | | | | | | | | | |
| 5pF(050) | | | | | | | | | | | | | | | | | | | | |
| 6.8pF(6R8) | | | | | | | | | | | | | | | | | | | | |
| 7pF(070) | | | | | | | | | | | | | | | | | | | | |
| 8pF(080) | | | | | | | | | | | | | | | | | | | | |
| 9pF(090) | | | | | | | | | | | | | | | | | | | | |
| 10pF(100) | | | | | | | | | | | | | | | | | | | | |
| 12pF(120) | | | | | | | | | | | | | | | | | | | | |
| 15pF(150) | | | | | | | | | | | | | | | | | | | | |
| 18pF(180) | | | | | | | | | | | | | | | | | | | | |
| 22pF(220) | | | | | | | | | | | | | | | | | | | | |
| 27pF(270) | | | | | | | | | | | | | | | | | | | | |
| 33pF(330) | | | | | | | | | | | | | | | | | | | | |
| 39pF(390) | | | | | | | | | | | | | | | | | | | | |
| 47pF(470) | | | | | | | | | | | | | | | | | | | | |
| 56pF(560) | | | | | | | | | | | | | | | | | | | | |
| 68pF(680) | | | | | | | | | | | | | | | | | | | | |
| 82pF(820) | | | | | | | | | | | | | | | | | | | | |
| 100pF(101) | | | | | | | | | | | | | | | | | | | | |
| 120pF(121) | | | | | | | | | | | | | | | | | | | | |
| 150pF(151) | | | | | | | | | | | | | | | | | | | | |
| 180pF(181) | | | | | | | | | | | | | | | | | | | | |
| 220pF(221) | | | | | | | | | | | | | | | | | | | | |
| 270pF(271) | | | | | | | | | | | | | | | | | | | | |
| 330pF(331) | | | | | | | | | | | | | | | | | | | | |
| 390pF(391) | | | | | | | | | | | | | | | | | | | | |
| 470pF(471) | | | | | | | | | | | | | | | | | | | | |
| 560pF(561) | | | | | | | | | | | | | | | | | | | | |
| 680pF(681) | | | | | | | | | | | | | | | | | | | | |
| 820pF(821) | | | | | | | | | | | | | | | | | | | | |
| 1000pF(102) | | | | | | | | | | | | | | | | | | | | |
| 1200pF(102) | | | | | | | | | | | | | | | | | | | | |
| 1500pF(152) | | | | | | | | | | | | | | | | | | | | |
| 1800pF(182) | | | | | | | | | | | | | | | | | | | | |
| 2200pF(222) | | | | | | | | | | | | | | | | | | | | |
| 3300pF(332) | | | | | | | | | | | | | | | | | | | | |
| 4700pF(472) | | | | | | | | | | | | | | | | | | | | |

Automotive Applications

Class II (X7R)

| Size Code (EIA Code) | 1005(0402) | | | | 1608(0603) | | | | 2012(0805) | | | | 3216(1206) | | | | 3225(1210) | | | |
|-------------------------|------------|----|----|-----|------------|----|----|-----|------------|----|----|-----|------------|----|----|-----|------------|----|----|-----|
| | 16 | 25 | 50 | 100 | 16 | 25 | 50 | 100 | 16 | 25 | 50 | 100 | 16 | 25 | 50 | 100 | 16 | 25 | 50 | 100 |
| Rated Volt.(V) | | | | | | | | | | | | | | | | | | | | |
| Cap. | | | | | | | | | | | | | | | | | | | | |
| 1000pF(102) | | | | | | | | | | | | | | | | | | | | |
| 1500pF(152) | | | | | | | | | | | | | | | | | | | | |
| 2200pF(222) | | | | | | | | | | | | | | | | | | | | |
| 3300pF(332) | | | | | | | | | | | | | | | | | | | | |
| 4700pF(472) | | | | | | | | | | | | | | | | | | | | |
| 6800pF(682) | | | | | | | | | | | | | | | | | | | | |
| 10000pF(103) | | | | | | | | | | | | | | | | | | | | |
| 15000pF(153) | | | | | | | | | | | | | | | | | | | | |
| 22000pF(223) | | | | | | | | | | | | | | | | | | | | |
| 33000pF(333) | | | | | | | | | | | | | | | | | | | | |
| 47000pF(473) | | | | | | | | | | | | | | | | | | | | |
| 68000pF(683) | | | | | | | | | | | | | | | | | | | | |
| 0.1uF(104) | | | | | | | | | | | | | | | | | | | | |
| 0.15uF(154) | | | | | | | | | | | | | | | | | | | | |
| 0.22uF(224) | | | | | | | | | | | | | | | | | | | | |
| 0.33uF(334) | | | | | | | | | | | | | | | | | | | | |
| 0.47uF(474) | | | | | | | | | | | | | | | | | | | | |
| 0.68uF(684) | | | | | | | | | | | | | | | | | | | | |
| 1.0uF(105) | | | | | | | | | | | | | | | | | | | | |
| 2.2uF(225) | | | | | | | | | | | | | | | | | | | | |
| 4.7uF(475) | | | | | | | | | | | | | | | | | | | | |
| 10uF(106) | | | | | | | | | | | | | | | | | | | | |
| 22uF(226) | | | | | | | | | | | | | | | | | | | | |

General Type for Automotive Application
 Thin Layer Large-Capacitance Type for Automotive Application

Typical Performance Characteristics

X8R

Application

The X8R series could be applicable to devices that operating in high-temperature environments
 Temperature Characteristics (x8r, -55 to 150°C, Capacitance Change $\pm 15\%$)
 Excellent DC-bias, Temperature and Aging properties

Dielectric Characteristics

| | |
|----------------------------|---|
| Temperature Characteristic | $\pm 15\%$ |
| Operating Temperature | -55~150°C |
| Capacitance Tolerance | $\pm 10\%$, $\pm 20\%$, |
| Dissipation Factor | 50V : 2.5% max. 25V : 3.0% max. 16V : 3.5% max. 10V : 5.0% max |
| Insulation Resistance | More than 10,000M Ω or 50 Ω F (Whichever is smaller) |
| Dielectric Strength | $> 2.5 \times RVDC$ |
| Test Voltage | 0.5 ~1.0Vrms |
| Test Frequency | 1 \pm 0.1kHz |

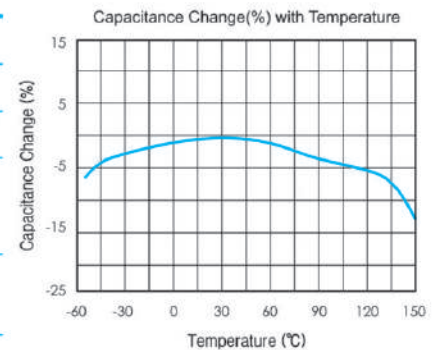

| Size Code (EIA Code) | 1608(0603) | | | | 2012(0805) | | | | 3216(1206) | | | |
|-------------------------|------------|----|----|-----|------------|----|----|-----|------------|----|----|-----|
| | 16 | 25 | 50 | 100 | 16 | 25 | 50 | 100 | 16 | 25 | 50 | 100 |
| Rated Volt.(V) | | | | | | | | | | | | |
| Cap. | | | | | | | | | | | | |
| 1000 μ F(102) | | | | | | | | | | | | |
| 4700 μ F(472) | | | | | | | | | | | | |
| 6800 μ F(682) | | | | | | | | | | | | |
| 10000 μ F(103) | | | | | | | | | | | | |
| 22000 μ F(223) | | | | | | | | | | | | |
| 470000 μ F(473) | | | | | | | | | | | | |
| 680000 μ F(683) | | | | | | | | | | | | |
| 0.1 μ F(104) | | | | | | | | | | | | |
| 0.15 μ F(154) | | | | | | | | | | | | |
| 0.22 μ F(224) | | | | | | | | | | | | |
| 0.47 μ F(474) | | | | | | | | | | | | |
| 0.68 μ F(684) | | | | | | | | | | | | |
| 1.0 μ F(105) | | | | | | | | | | | | |
| 2.2 μ F(225) | | | | | | | | | | | | |
| 4.7 μ F(475) | | | | | | | | | | | | |
| 10 μ F(106) | | | | | | | | | | | | |
| 22 μ F(226) | | | | | | | | | | | | |
| 47 μ F(226) | | | | | | | | | | | | |
| 100 μ F(226) | | | | | | | | | | | | |

Automotive Applications

Specifications and Test Methods (For Automotive Applications)

| No. | AEC-Q200 | | Specification | | Test Methods and Conditions | | | | | | | | | | | | | | | |
|-----------|-------------------------------------|--------------------|---|---|--|------|---|---|---|---|----------|----------|------|----------|------|-----------|------|---|------|---|
| | | | Class I | Class II | | | | | | | | | | | | | | | | |
| 1. | Pre-and Post-Stress Electrical Test | | | | | | | | | | | | | | | | | | | |
| 2. | High Temperature Exposure (Storage) | Appearance | No marking defects | | Temperature : 150±3℃ Maintenance Time : 1000+48/-0 hrs Let sit for 24±2 hours at room temperature, then measure. | | | | | | | | | | | | | | | |
| | | Capacitance Change | Within ±2.5% or ±0.25pF (Whichever is larger) | Within±10.0% | | | | | | | | | | | | | | | | |
| | | Q/D.F. | 30pF Min.: Q≥1000 30pF Max.: Q≥400+20×C C: Nominal Capacitance(pF) | Rated Voltage 16V Min.: 0.05 Max. 10V: 0.075 Max. | | | | | | | | | | | | | | | | |
| | | I.R. | More than 10,000MΩ or 500Ω·F (Whichever is smaller) | | | | | | | | | | | | | | | | | |
| 3. | Temperature Cycle | Appearance | No marking defects | | Perform the 1000 cycles according to the four heat treatments listed in the following table. Let sit for 24±2 hours at room temperature, then measure. | | | | | | | | | | | | | | | |
| | | Capacitance Change | Within ±2.5% or ±0.25pF (Whichever is larger) | Within±10.0% | | | | | | | | | | | | | | | | |
| | | Q/D.F. | 30pF Min.: Q≥1000 30pF Max.: Q≥400+20×C C: Nominal Capacitance(pF) | Rated Voltage 16V Min.: 0.05 Max. 10V: 0.075 Max. | | | | | | | | | | | | | | | | |
| | | I.R. | More than 10,000MΩ or 500Ω·F (Whichever is smaller) | | | | | | | | | | | | | | | | | |
| | | | | | <table border="1" style="width: 100%; text-align: center; border-collapse: collapse;"> <thead> <tr style="background-color: #00AEEF; color: white;"> <th>Step</th> <th>1</th> <th>2</th> <th>3</th> <th>4</th> </tr> </thead> <tbody> <tr> <td>Temp.(℃)</td> <td>-55+0/-3</td> <td>25±2</td> <td>125+3/-0</td> <td>25±2</td> </tr> <tr> <td>Time(min)</td> <td>15±3</td> <td>1</td> <td>15±3</td> <td>1</td> </tr> </tbody> </table> | Step | 1 | 2 | 3 | 4 | Temp.(℃) | -55+0/-3 | 25±2 | 125+3/-0 | 25±2 | Time(min) | 15±3 | 1 | 15±3 | 1 |
| Step | 1 | 2 | 3 | 4 | | | | | | | | | | | | | | | | |
| Temp.(℃) | -55+0/-3 | 25±2 | 125+3/-0 | 25±2 | | | | | | | | | | | | | | | | |
| Time(min) | 15±3 | 1 | 15±3 | 1 | | | | | | | | | | | | | | | | |
| | | | | | Initial measurement Perform the initial measurement according to Note 1 for Class II. | | | | | | | | | | | | | | | |
| 4. | Destructive Physical Analysis | | No defects or abnormalities | | Per EIA-469 | | | | | | | | | | | | | | | |
| 5. | Moisture Resistance | Appearance | No marking defects | | Temperature : 25~65℃, Humidity : 80~98% Cycle Time : 24 hrs/cycle, 10 cycles | | | | | | | | | | | | | | | |
| | | Capacitance Change | Within ±3.0% or ±0.30pF (Whichever is larger) | Within±12.5% | | | | | | | | | | | | | | | | |
| | | Q/D.F. | 30pF Min.: Q≥350 10pF Min. and 30pF Max.: Q≥275+5/2×C 10pF Max.: Q≥200+10×C C: Nominal Capacitance(pF) | Rated Voltage 16V Min.: 0.05 Max. 10V: 0.075 Max. | | | | | | | | | | | | | | | | |
| | | I.R. | More than 10,000MΩ or 500Ω·F (Whichever is smaller) | | | | | | | | | | | | | | | | | |
| | | | | | <p style="font-size: small;">The graph shows a temperature cycle between 25°C and 65°C. Humidity is maintained at 90-98% during the high-temperature phase. The cycle repeats every 24 hours. An initial measurement is indicated at the start of the cycle.</p> | | | | | | | | | | | | | | | |
| 6. | Biased Humidity | Appearance | No marking defects | | Temperature : 85±3℃ Humidity : 80~85% Applied Voltage : Rated Voltage and 1.3+0.2/-0V Maintenance Time : 1000+48/-0 hrs Let sit for 24±2 hours at room temperature, then measure. The charge/discharge current is less than 50mA. | | | | | | | | | | | | | | | |
| | | Capacitance Change | Within ±3.0% or ±0.30pF (Whichever is larger) | Within±12.5% | | | | | | | | | | | | | | | | |
| | | Q/D.F. | 30pF Min.: Q≥200 30pF Max.: Q≥100+10/3×C C: Nominal Capacitance(pF) | Rated Voltage 16V Min.: 0.05 Max. 10V: 0.075 Max. | | | | | | | | | | | | | | | | |
| | | I.R. | More than 10,000MΩ or 500Ω·F (Whichever is smaller) | | | | | | | | | | | | | | | | | |
| 7. | Operational Life | Appearance | No marking defects | | Temperature : 125±3℃ Applied Voltage : Rated Voltage × 200% Maintenance Time : 1000+48/-0 hrs Let sit for 24±2 hours at room temperature, then measure. The charge/discharge current is less than 50mA. Initial Measurement for Class II Applied 200% of the rated voltage for one hour at 125±3℃ Remove and let sit for 24±2 hours at room temperature, then measure. | | | | | | | | | | | | | | | |
| | | Capacitance Change | Within ±3.0% or ±0.30pF (Whichever is larger) | Within±12.5% | | | | | | | | | | | | | | | | |
| | | Q/D.F. | 30pF Min.: Q≥350 10pF Min. and 30pF Max.: Q≥275+5/2×C 10pF Max.: Q≥200+10×C C: Nominal Capacitance(pF) | Rated Voltage 16V Min.: 0.05 Max. 10V: 0.075 Max. | | | | | | | | | | | | | | | | |
| | | I.R. | More than 10,000MΩ or 500Ω·F (Whichever is smaller) | | | | | | | | | | | | | | | | | |

| No. | AEC-Q200 | | Specification | | Test Methods and Conditions | |
|-----|------------------------------|--------------------|---|---|--|--|
| | | | Class I | Class II | | |
| 8. | External Visual | | No defects or abnormalities | | Visual inspection | |
| 9. | Physical Dimension | | Within the specified dimensions | | Using calipers | |
| 10. | Resistance to Solvents | Appearance | No marking defects | | Per MIL-STD-202 Method 215 | |
| | | Capacitance Change | Within the specified tolerance | | | |
| | | Q/D.F. | 30pF Min.: $Q \geq 1000$ 30pF Max.: $Q \geq 400 + 20 \times C$ C: Nominal Capacitance(pF) | Rated Voltage 50V: 0.025 Max. 25V: 0.03 Max. 16V: 0.035 Max. 10V: 0.05 Max. | | |
| | | I.R. | More than 10,000M Ω or 500 Ω ·F (Whichever is smaller) | | | |
| 11. | Mechanical Shock | Appearance | No marking defects | | Three shocks in each direction should be applied along 3 mutually perpendicular axes of the test specimen (18 shocks) Test Pulse Wave form : Half-sine Duration : 0.5ms Peak value : 1,500G Velocity change : 4.7m/s | |
| | | Capacitance Change | Within the specified tolerance | | | |
| | | Q/D.F. | 30pF Min.: $Q \geq 1000$ 30pF Max.: $Q \geq 400 + 20 \times C$ C: Nominal Capacitance(pF) | Rated Voltage 50V: 0.025 Max. 25V: 0.03 Max. 16V: 0.035 Max. 10V: 0.05 Max. | | |
| | | I.R. | More than 10,000M Ω or 500 Ω ·F (Whichever is smaller) | | | |
| 12. | Vibration | Appearance | No defects or abnormalities | | The specimens should be subjected to a simple harmonic motion having a total amplitude of 1.5mm. The entire frequency range of 10 to 2,000 Hz and return to 10 Hz should be traversed in 20 minutes. This cycle should be performed 12 times in each of three mutually perpendicular directions (total of 36 times). | |
| | | Capacitance Change | Within the specified tolerance | | | |
| | | Q/D.F. | 30pF Min.: $Q \geq 1000$ 30pF Max.: $Q \geq 400 + 20 \times C$ C: Nominal Capacitance(pF) | Rated Voltage 50V: 0.025 Max. 25V: 0.03 Max. 16V: 0.035 Max. 10V: 0.05 Max. | | |
| | | I.R. | More than 10,000M Ω or 500 Ω ·F (Whichever is smaller) | | | |
| 13. | Resistance to Soldering Heat | Appearance | No marking defects | | Temperature(Eutectic solder solution) : 260 \pm 5 $^{\circ}$ C Dipping Time : 10 \pm 1s Let sit for 24 \pm 2 hours at room temperature, then measure. Initial measurement Perform the initial measurement according to Note 1 for Class II. | |
| | | Capacitance Change | Within the specified tolerance | | | |
| | | Q/D.F. | 30pF Min.: $Q \geq 1000$ 30pF Max.: $Q \geq 400 + 20 \times C$ C: Nominal Capacitance(pF) | Rated Voltage 50V: 0.025 Max. 25V: 0.03 Max. 16V: 0.035 Max. 10V: 0.05 Max. | | |
| | | I.R. | More than 10,000M Ω or 500 Ω ·F (Whichever is smaller) | | | |

Automotive Applications

| No. | AEC-Q200 | | Specification | | Test Methods and Conditions | | | | | | | | | | | | | | | | | | | |
|---------------|--|--|---|--|---|--|-------|-----------------|-----------|----------|-----------|----------|----------|-----------|----------|----------|-----------|----------|---------|----------|-----------|--------|----------|-------------|
| | | | Class I | Class II | | | | | | | | | | | | | | | | | | | | |
| 14. | Thermal Shock | Appearance | No marking defects | | Perform the 300 cycles according to the two heat treatments listed in the following table. Transfer Time : 20s Max. Let sit for 24±2 hours at room temperature, then measure. | | | | | | | | | | | | | | | | | | | |
| | | Capacitance Change | Within ±3.0% or ±0.30pF (Whichever is larger) | Within±12.5% | | | | | | | | | | | | | | | | | | | | |
| | | Q/D.F. | 30pF Min.: Q≥1000 30pF Max.: Q≥400+20×C C: Nominal Capacitance(pF) | Rated Voltage 50V: 0.025 Max. 25V: 0.03 Max. 16V: 0.035 Max. 10V: 0.05 Max. | | | | | | | | | | | | | | | | | | | | |
| | | I.R. | More than 10,000MΩ or 500Ω·F (Whichever is smaller) | | | | | | | | | | | | | | | | | | | | | |
| | | | | <table border="1"> <thead> <tr> <th>Step</th> <th>1</th> <th>2</th> </tr> </thead> <tbody> <tr> <td>Temp.(°C)</td> <td>-55+0/-3</td> <td>125+3/-0</td> </tr> <tr> <td>Time(min)</td> <td>15±3</td> <td>15±3</td> </tr> </tbody> </table> | Step | 1 | 2 | Temp.(°C) | -55+0/-3 | 125+3/-0 | Time(min) | 15±3 | 15±3 | | | | | | | | | | | |
| Step | 1 | 2 | | | | | | | | | | | | | | | | | | | | | | |
| Temp.(°C) | -55+0/-3 | 125+3/-0 | | | | | | | | | | | | | | | | | | | | | | |
| Time(min) | 15±3 | 15±3 | | | | | | | | | | | | | | | | | | | | | | |
| | | | | Initial measurement Perform the initial measurement according to Note 1 for Class II. | | | | | | | | | | | | | | | | | | | | |
| 15. | ESD | Appearance | No marking defects | | Per AEC-Q200-002 | | | | | | | | | | | | | | | | | | | |
| | | Capacitance Change | Within the specified tolerance | | | | | | | | | | | | | | | | | | | | | |
| | | Q/D.F. | 30pF Min.: Q≥1000 30pF Max.: Q≥400+20×C C: Nominal Capacitance(pF) | Rated Voltage 50V: 0.025 Max. 25V: 0.03 Max. 16V: 0.035 Max. 10V: 0.05 Max. | | | | | | | | | | | | | | | | | | | | |
| | | I.R. | More than 10,000MΩ or 500Ω·F (Whichever is smaller) | | | | | | | | | | | | | | | | | | | | | |
| 16. | Solderability | 95% of the terminations is to be soldered evenly and continuously. | | (a) Preheat at 155°C for 4 hours, and then immerse the capacitor in a solution of ethanol and rosin. Immerse in eutectic solder solution for 5+0/-0.5 seconds at 235±5°C. (b) Steam aging for 8 hours, and then immerse the capacitor in a solution of ethanol and rosin. Immerse in eutectic solder solution for 5+0/-0.5 seconds at 235±5°C. (c) Steam aging for 8 hours, and then immerse the capacitor in a solution of ethanol and rosin. Immerse in eutectic solder solution for 120±5 seconds at 260±5°C. | | | | | | | | | | | | | | | | | | | | |
| 17. | Electrical Characterization | Appearance | No defects or abnormalities | | The capacitance/Q/D.F. should be measured at 25°C at the frequency and voltage shown in the table | | | | | | | | | | | | | | | | | | | |
| | | Capacitance Change | Within the specified tolerance | | | | | | | | | | | | | | | | | | | | | |
| | | Q/D.F. | 30pF Min.: Q≥1000 30pF Max.: Q≥400+20×C C: Nominal Capacitance(pF) | Rated Voltage 50V: 0.025 Max. 25V: 0.03 Max. 16V: 0.035 Max. 10V: 0.05 Max. | | <table border="1"> <thead> <tr> <th>Class</th> <th>Capacitance (C)</th> <th>Frequency</th> <th>Voltage</th> </tr> </thead> <tbody> <tr> <td rowspan="2">Class I</td> <td>C≤1000pF</td> <td>1±0.1MHz</td> <td>0.5-5Vrms</td> </tr> <tr> <td>C>1000pF</td> <td>1±0.1kHz</td> <td>1±0.2Vrms</td> </tr> <tr> <td rowspan="2">Class II</td> <td>C≤110μF</td> <td>1±0.1kHz</td> <td>1±0.2Vrms</td> </tr> <tr> <td>C>10μF</td> <td>120±24Hz</td> <td>0.5±0.1Vrms</td> </tr> </tbody> </table> | Class | Capacitance (C) | Frequency | Voltage | Class I | C≤1000pF | 1±0.1MHz | 0.5-5Vrms | C>1000pF | 1±0.1kHz | 1±0.2Vrms | Class II | C≤110μF | 1±0.1kHz | 1±0.2Vrms | C>10μF | 120±24Hz | 0.5±0.1Vrms |
| | | Class | Capacitance (C) | Frequency | | Voltage | | | | | | | | | | | | | | | | | | |
| | | Class I | C≤1000pF | 1±0.1MHz | | 0.5-5Vrms | | | | | | | | | | | | | | | | | | |
| C>1000pF | 1±0.1kHz | | 1±0.2Vrms | | | | | | | | | | | | | | | | | | | | | |
| Class II | C≤110μF | 1±0.1kHz | 1±0.2Vrms | | | | | | | | | | | | | | | | | | | | | |
| | C>10μF | 120±24Hz | 0.5±0.1Vrms | | | | | | | | | | | | | | | | | | | | | |
| I.R. at 25°C | More than 100,000MΩ or 1,000Ω·F (Whichever is smaller) | More than 100,000MΩ or 500Ω·F (Whichever is smaller) | Should be measured with a DC voltage not exceeding rated voltage at 25°C and 125°C for 2 minutes of charging. | | | | | | | | | | | | | | | | | | | | | |
| I.R. at 125°C | More than 10,000MΩ or 100Ω·F (Whichever is smaller) | More than 10,000MΩ or 10Ω·F (Whichever is smaller) | | | | | | | | | | | | | | | | | | | | | | |

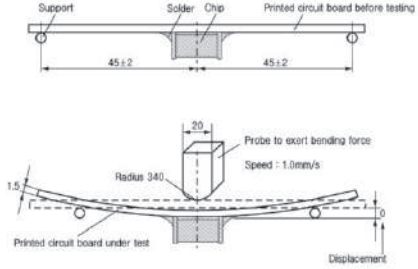
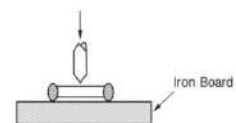
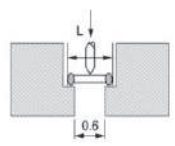
| No. | AEC-Q200 | | Specification | | Test Methods and Conditions |
|-----|-------------------|---------------------|---|---------------|--|
| | | | Class I | Class II | |
| 17. | | Dielectric Strength | No dielectric breakdown or mechanical breakdown | | Applied 250% of the rated voltage for 1-5 seconds The charge/discharge current is less than 50mA. |
| 18. | Board Flex | Appearance | No marking defects | | Apply a force in the direction shown in the following figure for 5±1 seconds.  |
| | | Capacitance Change | Within ±5.0% or ±0.5pF (Whichever is larger) | Within ±10.0% | |
| 19. | Terminal Strength | Appearance | No marking defects | | Apply *18N force in parallel with the test jig for 60±1 seconds. *10N for 1608(EIA:0603) size 2N for 1005(EIA:0402) size |
| | | Capacitance Change | Within ±5.0% or ±0.5pF (Whichever is larger) | Within ±10.0% | |
| 20. | Beam Load Test | | The chip endure following force. | | Apply a force as shown in the following figure. (i) Chip Length : 2.5mm Max. Beam Speed : 0.5mm/s  (ii) Chip Length : 3.2mm Min. Beam Speed : 2.5mm/s  |

| Chip Length | Thickness (T) | Force |
|-------------|---------------|-------|
| 2.5mm Max. | T ≤ 0.5mm | 8N |
| | T > 0.5mm | 20N |
| 3.2mm Min. | T < 1.25mm | 15N |
| | T ≥ 1.25 | 54.5N |

Automotive Applications

| No. | AEC-Q200 | | Specification | | Test Methods and Conditions |
|-----|---|-------------------------|---|-------------|---|
| | | | Class I | Class II | |
| 21. | Capacitance Temperature Characteristics | Capacitance Change | | Within ±15% | (i) Class I The temperature coefficient is determined using the capacitance measured in step 3 as a reference. When cycling the temperature sequentially from step 1 through 5, the capacitance should be within the specified tolerance for the temperature coefficient. The capacitance drift is calculated by dividing the differences between the maximum and minimum measured values in steps 1, 3 and 5 by the capacitance value in step 3. |
| | | Temperature Coefficient | 0 ± 30 ppm/°C | | |
| | | Capacitance Drift | Within ±0.2% or ±0.05pF (Whichever is larger) | | |

| Step | 1 | 2 | 3 | 4 | 5 |
|-----------|--------|---------|--------|---------|--------|
| Temp.(°C) | 25 ± 2 | -55 ± 3 | 25 ± 2 | 125 ± 3 | 25 ± 2 |

| | | | | | |
|---|--|--|--|--|--|
| (ii) Class II The ranges of capacitance change compared with the 25°C value over the temperature range from -55°C to 125°C Initial measurement Perform the initial measurement according to Note 1 for Class II. | | | | | |
|---|--|--|--|--|--|

*Note 1. Initial Measurement for Class II

Perform a heat treatment at 150+0/-10°C for one hour, and then let sit for 24 ± 2 hours at room temperature, then measure.

Packing

Bulk packing

- ① 1000 pcs per Polybag
- ② 5 Polybags per Inner box
- ③ 10 Inner boxes per Out box

Reel Packing

- ① 8~10 Reels per Inner box
- ② 10 Inner boxes per Out box

Reel Dimensions

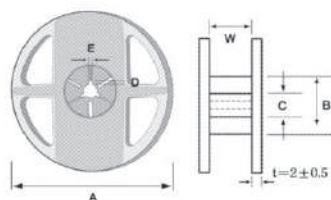

| Mark | Size Code | EIA Code | A | B | C | D | E | W |
|----------|-----------|-----------|--------|---------|---------|---------|-------|--------|
| 7" REEL | 1005~3225 | 0402~1210 | ∅178±2 | ∅50Min. | ∅13±0.5 | ∅21±0.8 | 2±0.5 | 10±1.5 |
| 13" REEL | 1005~3225 | 0402~1210 | ∅330±2 | ∅70Min. | ∅13±0.5 | ∅21±0.8 | 2±0.5 | 10±1.5 |

Number of Packages

| Type | EIA CODE | 7" Quantity(EA)/Reel | 13" Quantity(EA)/Reel |
|------|----------|----------------------|-----------------------|
| 1005 | 0402 | 10,000 | 50,000 |
| 1608 | 0603 | 4,000 | 16,000 |
| 2012 | 0805 | 3,000 ~ 4,000 | 10,000 |
| 3216 | 1206 | 2,000 ~ 4,000 | 6,000 ~ 10,000 |
| 3225 | 1210 | 1,000 ~ 3,000 | 4,000 ~ 10,000 |

Tape Dimensions

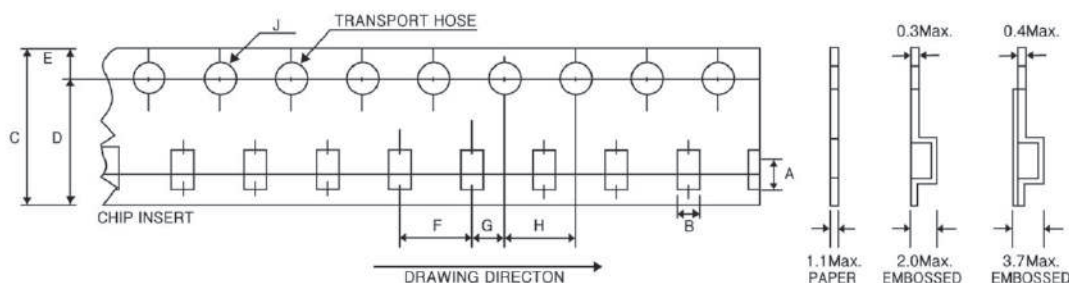

| TYPE | EIA CODE | A | B | C | D | E | F | G | H | J |
|------|----------|----------|----------|---------|----------|----------|----------|---------|---------|---------|
| 1005 | 0402 | 1.15±0.1 | 0.65±0.1 | 8.0±0.3 | 3.5±0.05 | 1.75±0.1 | 2.0±0.05 | 2.0±0.1 | 4.0±0.1 | 1.5±0.1 |
| 1608 | 0603 | 1.9±0.2 | 1.10±0.2 | 8.0±0.3 | 3.5±0.05 | 1.75±0.1 | 4.0±0.1 | 2.0±0.1 | 4.0±0.1 | 1.5±0.1 |
| 2012 | 0805 | 2.4±0.2 | 1.65±0.2 | 8.0±0.3 | 3.5±0.05 | 1.75±0.1 | 4.0±0.1 | 2.0±0.1 | 4.0±0.1 | 1.5±0.1 |
| 3216 | 1206 | 3.6±0.2 | 2.00±0.2 | 8.0±0.3 | 3.5±0.05 | 1.75±0.1 | 4.0±0.1 | 2.0±0.1 | 4.0±0.1 | 1.5±0.1 |
| 3225 | 1210 | 3.6±0.2 | 2.80±0.2 | 8.0±0.3 | 3.5±0.05 | 1.75±0.1 | 4.0±0.1 | 2.0±0.1 | 4.0±0.1 | 1.5±0.1 |

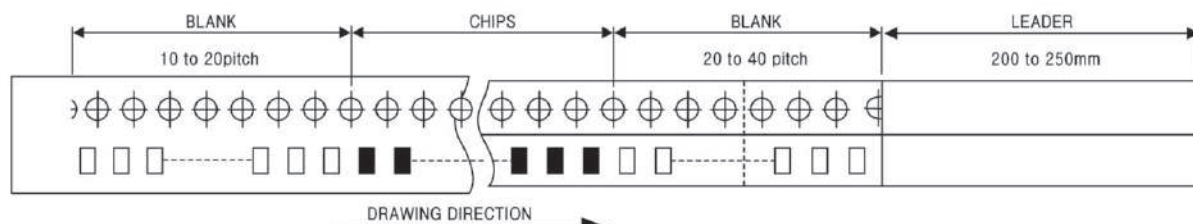

Automotive Applications

Caution

▶ Storage Condition

When solderability is considered, capacitor are recommended to be used in 12 months.

- (1) Temperature: 25°C ± 10°C
- (2) Relative Humidity: Below 70% RH

▶ The Regulation of Environmental Pollution Materials

Never use materials mentioned below in MLCC products regulated this document.

Pb, Cd, Hg, Cr⁺⁶, PBB(Polybrominated biphenyl), PBDE(Polybrominated diphenyl ethers), asbestos

▶ Mounting Position

Choose a mounting position that minimizes the stress imposed on the chip during flexing or bending of the board.

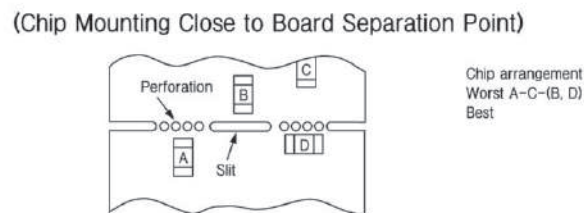
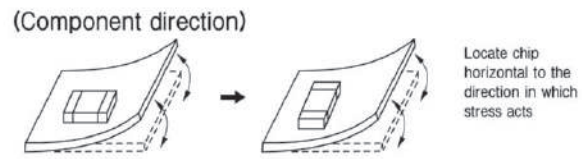

▶ Reflow Soldering

1. The sudden temperature change easily causes mechanical damages to ceramic components. Therefore, the preheating procedures should be required for the soldering of ceramic components.
2. Please refer to the recommended soldering profiles as shown in figures, and keep the temperature difference(ΔT) within the range recommended in Table 1.

Table 1.

| Size code (EIA Code) | Temperature Difference |
|-----------------------|-----------------------------------|
| 1005~3216 (0402~1206) | $\Delta T \leq 190^\circ\text{C}$ |
| 3225 (1210) | $\Delta T \leq 130^\circ\text{C}$ |

Infrared Reflow

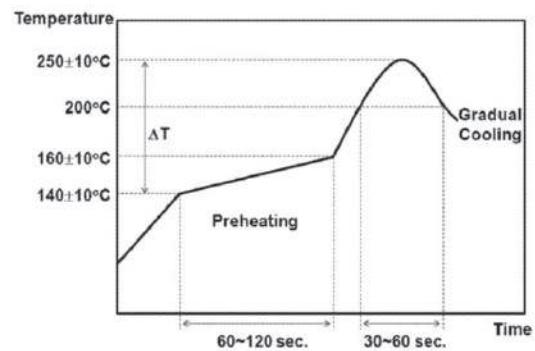

Vapor Reflow

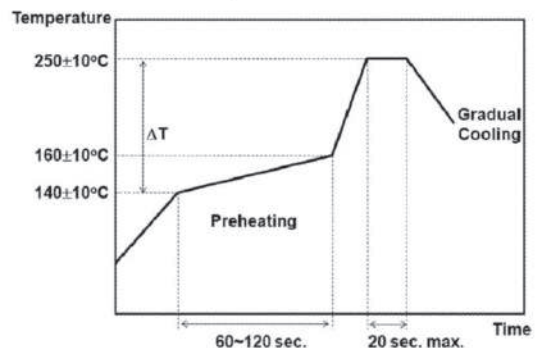

▶ 'Aging'/'De-aging' behavior of high dielectric constant type MLCCs

(Typically represented by X7R temperature characteristic of which main composition is BaTiO₃)

'Aging' / 'De-aging' Behavior of high dielectric MLCCs Please note that high dielectric type dielectric ceramic capacitors have a "normal" 'aging' behavior / characteristic, that is; their capacitance value decreases with time from its value when it was first manufactured. From that date, the capacitance value begins to decrease at a logarithmic rate defined by:

$$C_t = C_{48}(1 - k \log_{10} t)$$

- C_t : Capacitance value, t hours after the start of 'aging'
- C₄₈ : Capacitance value, 48 hours after its manufacture
- k : Aging constant (capacitance decrease per decade-hour)
- t : time, in hours, from the start of 'aging'

Ceramic's Capacitance Change(%) versus Time (hours)

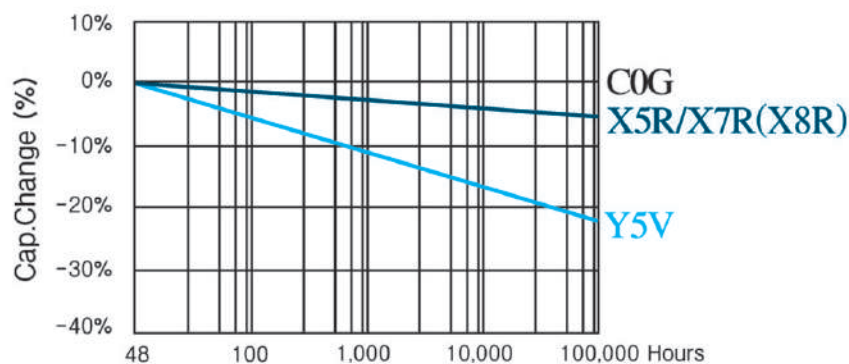

The capacitance value can be restored(also known as 'de-aged') by exposing the component to elevated temperatures approaching its curie temperature(approximately 120°C). This 'de-aging' can occur during the component's solder-assembly onto the PCB, during life or temperature cycle testing, or by baking at 150°C for about 1 hour.

| Dielectric | Maximum percent capacitance loss per decade hour, k |
|------------|---|
| C0G | 0 |
| X7R | ~3% |

X-ON Electronics

Largest Supplier of Electrical and Electronic Components

Click to view similar products for [Multilayer Ceramic Capacitors MLCC - SMD/SMT](#) category:

Click to view products by [Samwha](#) manufacturer:

Other Similar products are found below :

[M39014/02-1218V](#) [M39014/02-1225V](#) [M39014/22-0631](#) [D55342E07B523DR-T/R](#) [NIN-FB391JTRF](#) [NIN-FC2R7JTRF](#)
[NMC0402NPO220J50TRPF](#) [NMC0402X5R105K6.3TRPF](#) [NMC0402X5R224K6.3TRPF](#) [NMC0402X7R103J25TRPF](#)
[NMC0402X7R392K50TRPF](#) [NMC0603NPO201J50TRPF](#) [NMC0603NPO330G50TRPF](#) [NMC0603NPO331F50TRPF](#)
[NMC0603X5R475M6.3TRPF](#) [NMC0603X7R333K16TRPF](#) [NMC0805NPO220J100TRPF](#) [NMC0805NPO820J50TRPF](#)
[NMC1206X7R102K50TRPF](#) [NMC1206X7R106K10TRPLPF](#) [NMC-H0805X7R472K250TRPF](#) [C1608C0G2A221J](#) [C1608X7R1E334K](#)
[C2012C0G2A472J](#) [2220J2K00562KXT](#) [CCR06CG153FSV](#) [CDR33BX104AKUR](#) [CDR33BX683AKUS](#) [CGA3E1X7R1C684K](#)
[CL10C0R8BB8ANNC](#) [M55342H06B20G0R-T/R](#) [C1005X5R0G225M](#) [C2012X7R2E223K](#) [C3216C0G2J272J](#) [D55342E07B35E7R-T/R](#)
[CDR34BX563BKUS](#) [CDR34BX563BKWS](#) [NMC0402NPO220F50TRPF](#) [NMC0402X7R562J25TRPF](#) [NMC0603NPO102J25TRPF](#)
[NMC1206X7R332K50TRPF](#) [NMC-P1206X7R104K250TRPLPF](#) [726632-1](#) [CGA6M3X7R1H225K](#) [CGA5L2X7R2A105K](#)
[CGA3E2X8R1H223K](#) [CDR33BX823AKUR\M500](#) [CDR33BP132BJUR](#) [CDR35BX474AKUR\M500](#) [CDR35BX104BKUR\M500](#)