

N-channel Enhanced mode TO-220/TO-263 MOSFET

Features

- High ruggedness
- Low $R_{DS(ON)}$ (Typ 7.6m Ω)@ $V_{GS}=10V$
- Low Gate Charge (Typ 70nC)
- Improved dv/dt Capability
- 100% Avalanche Tested
- Application: Synchronous Rectification, Li Battery Protect Board, Inverter

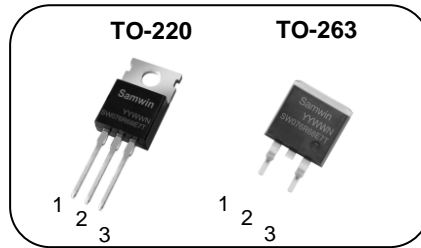

1. Gate 2.Drain 3.Source

BV_{DSS} : 68V
 I_D : 85A
 $R_{DS(ON)}$: 7.6m Ω

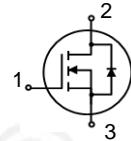

General Description

This power MOSFET is produced with advanced technology of SAMWIN. This technology enable the power MOSFET to have better characteristics, including fast switching time, low on resistance, low gate charge and especially excellent avalanche characteristics.



Order Codes

Item	Sales Type	Marking	Package	Packaging
1	SW P 076R68E7T	SW076R68E7T	TO-220	TUBE
2	SW B 076R68E7T	SW076R68E7T	TO-263	TUBE

Absolute maximum ratings

Symbol	Parameter	Value		Unit
		TO-220	TO-263	
V_{DSS}	Drain to source voltage	68		V
I_D	Continuous drain current (@ $T_C=25^{\circ}C$)	85*		A
	Continuous drain current (@ $T_C=100^{\circ}C$)	62*		A
I_{DM}	Drain current pulsed (note 1)	340		A
V_{GS}	Gate to source voltage	± 20		V
E_{AS}	Single pulsed avalanche energy (note 2)	180		mJ
E_{AR}	Repetitive avalanche energy (note 1)	18		mJ
dv/dt	Peak diode recovery dv/dt (note 3)	5		V/ns
P_D	Total power dissipation (@ $T_C=25^{\circ}C$)	138.9		W
	Derating factor above 25 $^{\circ}C$	1.1		W/ $^{\circ}C$
T_{STG}, T_J	Operating junction temperature & storage temperature	-55 ~ + 150		$^{\circ}C$
T_L	Maximum lead temperature for soldering purpose, 1/8 from case for 5 seconds.	300		$^{\circ}C$

*. Drain current is limited by junction temperature.

Thermal characteristics

Symbol	Parameter	Value		Unit
		TO-220	TO-263	
R_{thjc}	Thermal resistance, Junction to case	0.9		$^{\circ}C/W$
R_{thja}	Thermal resistance, Junction to ambient	49		$^{\circ}C/W$

Electrical characteristic (T_J = 25°C unless otherwise specified)

Symbol	Parameter	Test conditions	Min.	Typ.	Max.	Unit
Off characteristics						
BV _{DSS}	Drain to source breakdown voltage	V _{GS} =0V, I _D =250uA	68			V
ΔBV _{DSS} / ΔT _J	Breakdown voltage temperature coefficient	I _D =250uA, referenced to 25°C		0.09		V/°C
I _{DSS}	Drain to source leakage current	V _{DS} =68V, V _{GS} =0V			1	uA
		V _{DS} =54V, T _J =125°C			50	uA
I _{GSS}	Gate to source leakage current, forward	V _{GS} =20V, V _{DS} =0V			100	nA
	Gate to source leakage current, reverse	V _{GS} =-20V, V _{DS} =0V			-100	nA
On characteristics						
V _{GS(TH)}	Gate threshold voltage	V _{DS} =V _{GS} , I _D =250uA	2		4	V
R _{DS(ON)}	Drain to source on state resistance	V _{GS} =10V, I _D =40A, T _J =25°C		7.6	8.8	mΩ
		V _{GS} =10V, I _D =40A, T _J =125°C		12.3		mΩ
G _{fs}	Forward transconductance	V _{DS} =5V, I _D =40A		50		S
Dynamic characteristics						
C _{iss}	Input capacitance	V _{GS} =0V, V _{DS} =34V, f=1MHz		3467		pF
C _{oss}	Output capacitance			222		
C _{rss}	Reverse transfer capacitance			200		
t _{d(on)}	Turn on delay time	V _{DS} =34V, I _D =30A, R _G =4.7Ω, V _{GS} =10V (note 4,5)		22		ns
t _r	Rising time			58		
t _{d(off)}	Turn off delay time			56		
t _f	Fall time			25		
Q _g	Total gate charge	V _{DS} =54V, V _{GS} =10V, I _D =30A, I _G =3mA (note 4,5)		70		nC
Q _{gs}	Gate-source charge			19		
Q _{gd}	Gate-drain charge			26		
R _g	Gate resistance		V _{DS} =0V, Scan F mode		3.7	

Source to drain diode ratings characteristics

Symbol	Parameter	Test conditions	Min.	Typ.	Max.	Unit
I _S	Continuous source current	Integral reverse p-n Junction diode in the MOSFET			85	A
I _{SM}	Pulsed source current				340	A
V _{SD}	Diode forward voltage drop.	I _S =45A, V _{GS} =0V			1.4	V
t _{rr}	Reverse recovery time	I _S =30A, V _{GS} =0V,		34		ns
Q _{rr}	Reverse recovery charge	dI _F /dt=100A/us		45		nC

※. Notes

1. Repeattive rating : pulse width limited by junction temperature.
2. L =0.5mH, I_{AS} =26.8A, V_{DD}=30V, R_G=25Ω, Starting T_J = 25°C
3. I_{SD} ≤30A, di/dt = 100A/us, V_{DD} ≤ BV_{DSS}, Starting T_J =25°C
4. Pulse Test : Pulse Width ≤ 300us, duty cycle ≤ 2%.
5. Essentially independent of operating temperature.

Fig. 1. On-state characteristics

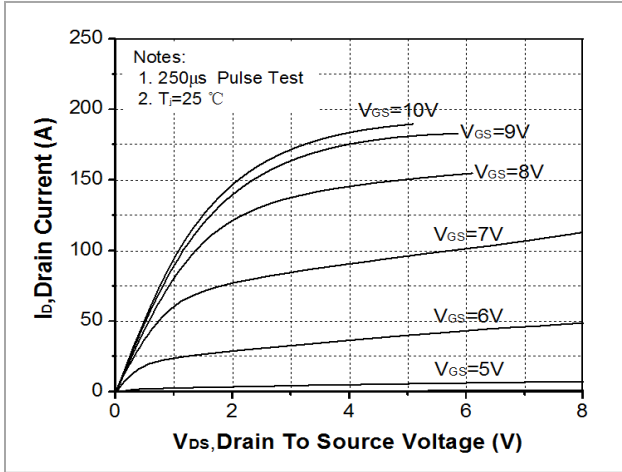

Fig. 2. Transfer Characteristics

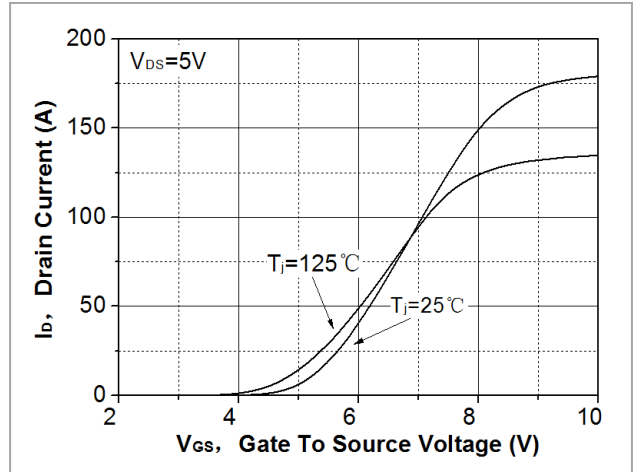

Fig. 3. On-resistance variation vs. drain current and gate voltage

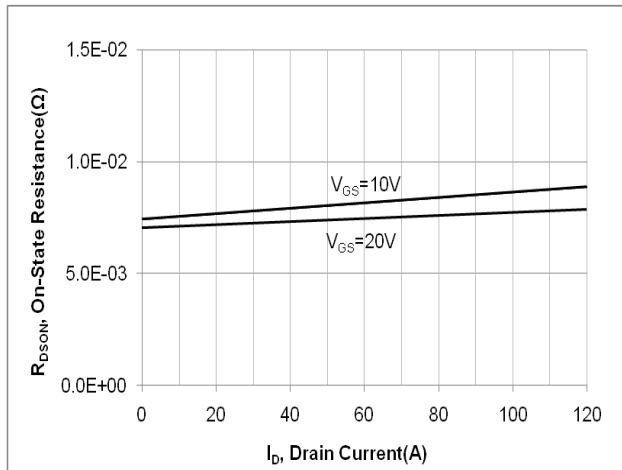

Fig. 4. On-state current vs. diode forward voltage

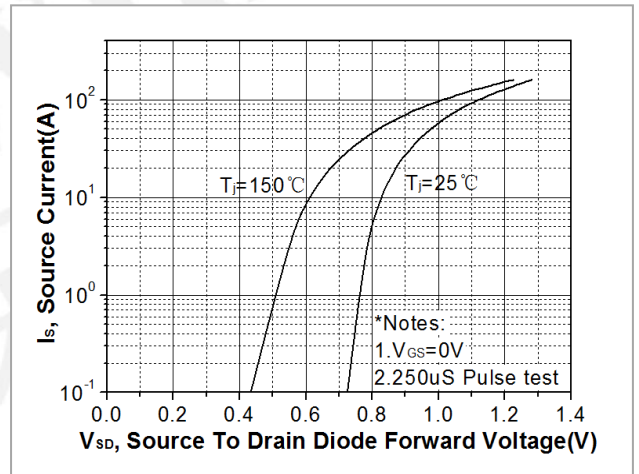

Fig 5. Breakdown voltage variation vs. junction temperature

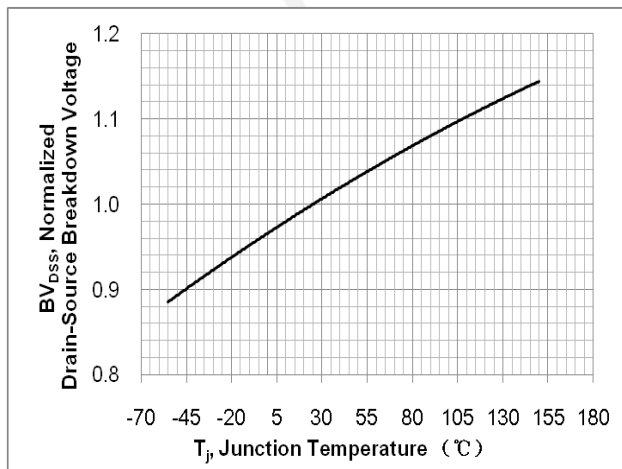

Fig. 6. On-resistance variation vs. junction temperature

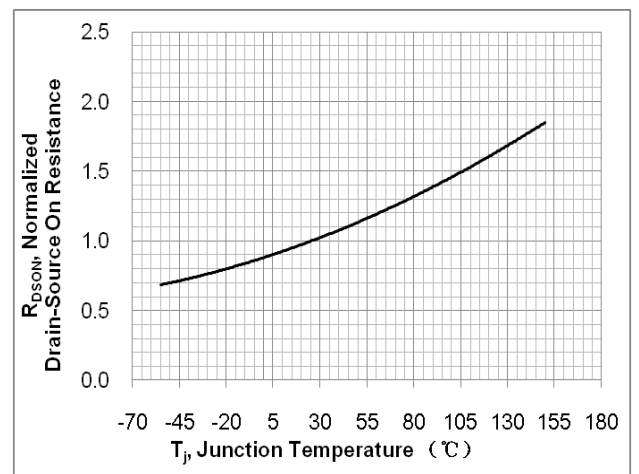

Fig. 7. Gate charge characteristics

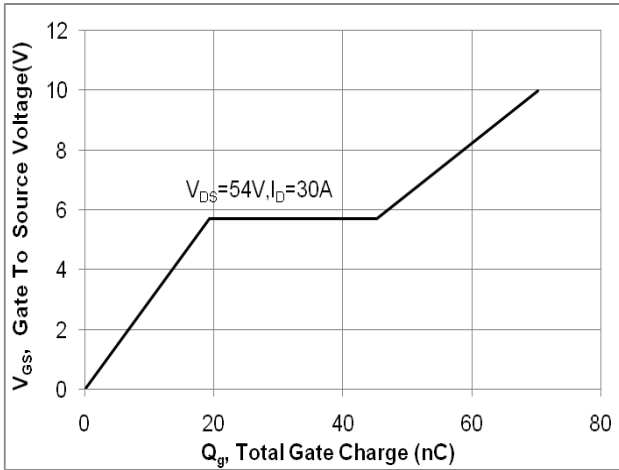

Fig. 8. Capacitance Characteristics

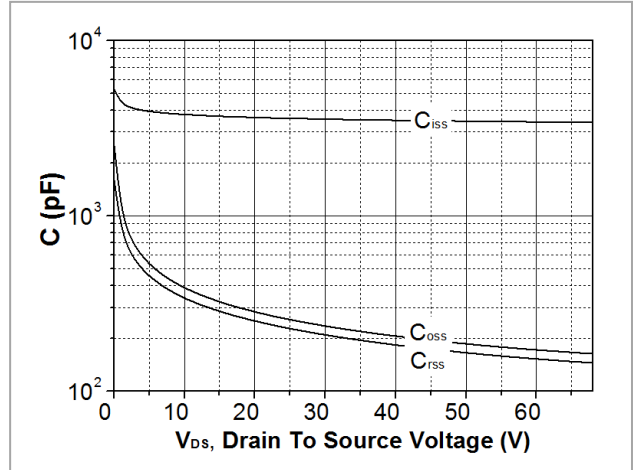

Fig. 9. Maximum safe operating area (TO-220&TO-263)

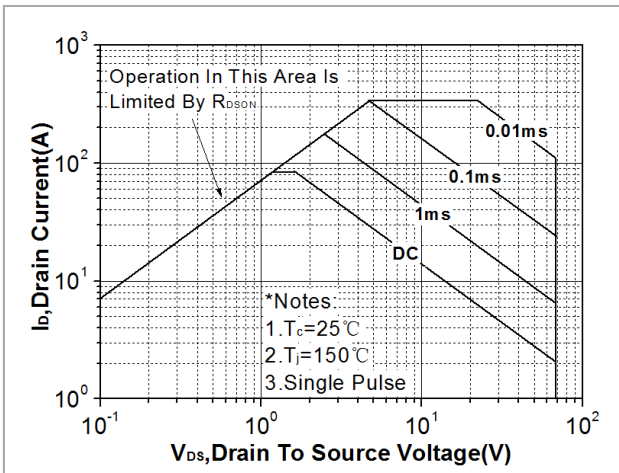

Fig. 10. Maximum drain current vs. case temperature

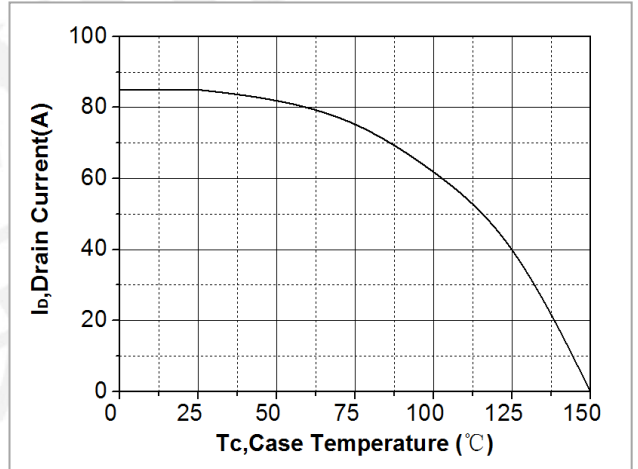

Fig. 11. Transient thermal response curve(TO-220&TO-263)

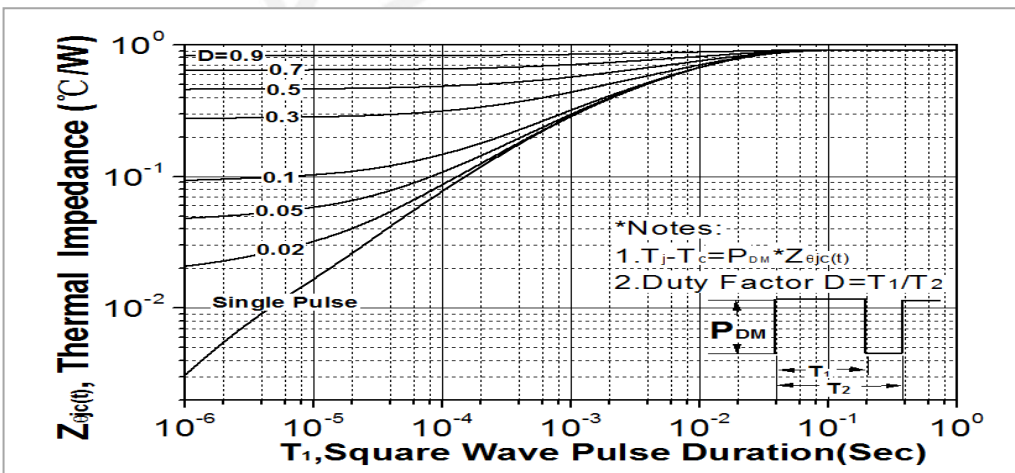

Fig. 12. Gate charge test circuit & waveform

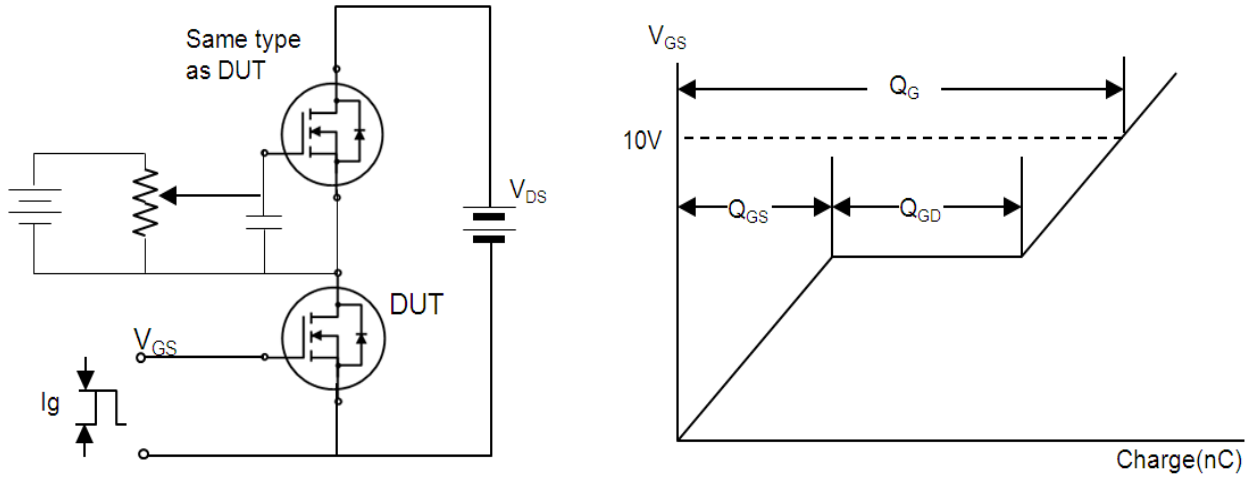

Fig. 13. Switching time test circuit & waveform

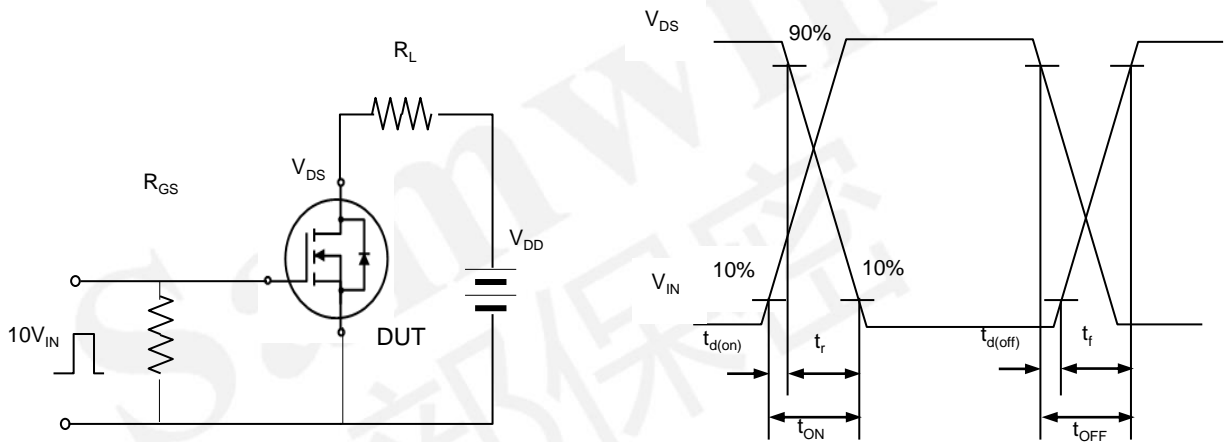
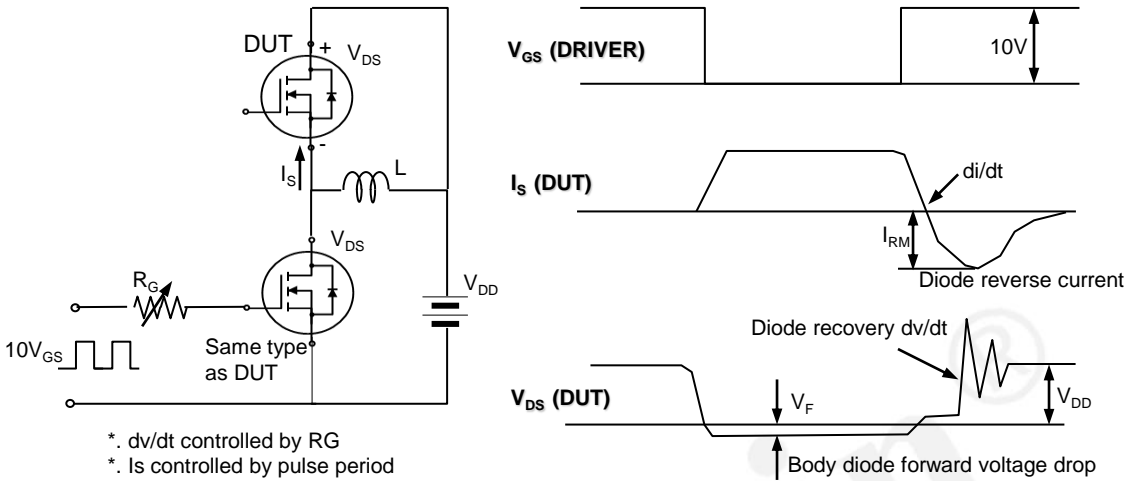

Fig. 14. Unclamped Inductive switching test circuit & waveform



Fig. 15. Peak diode recovery dv/dt test circuit & waveform



DISCLAIMER

* All the data & curve in this document was tested in SEMIPOWER TESTING & APPLICATION CENTER.

* This product has passed the PCT,TC,HTRB,HTGB,HAST,PC and Solderdunk reliability testing.

* Qualification standards can also be found on the Web site (<http://www.semipower.com.cn>) 

* Suggestions for improvement are appreciated, Please send your suggestions to samwin@samwinsemi.com

X-ON Electronics

Largest Supplier of Electrical and Electronic Components

Click to view similar products for [MOSFET](#) category:

Click to view products by [Sam&wing](#) manufacturer:

Other Similar products are found below :

[IRFD120](#) [JANTX2N5237](#) [2SK2267\(Q\)](#) [BUK455-60A/B](#) [TK100A10N1,S4X\(S](#) [MIC4420CM-TR](#) [VN1206L](#) [NDP4060](#) [SI4482DY](#)
[IRS2092STRPBF-EL](#) [IPS70R2K0CEAKMA1](#) [TK31J60W5,S1VQ\(O](#) [TK31J60W,S1VQ\(O](#) [TK16J60W,S1VQ\(O](#) [2SK2614\(TE16L1,Q\)](#)
[DMN1017UCP3-7](#) [EFC2J004NUZTDG](#) [P85W28HP2F-7071](#) [DMN1053UCP4-7](#) [NTE2384](#) [DMC2700UDMQ-7](#) [DMN2080UCB4-7](#)
[DMN61D9UWQ-13](#) [US6M2GTR](#) [DMN31D5UDJ-7](#) [DMP22D4UFO-7B](#) [IPS60R3K4CEAKMA1](#) [DMN1006UCA6-7](#) [DMN16M9UCA6-7](#)
[STF5N65M6](#) [IRF40H233XTMA1](#) [STU5N65M6](#) [DMN6022SSD-13](#) [DMN13M9UCA6-7](#) [DMTH10H4M6SPS-13](#) [IPS60R360PFD7SAKMA1](#)
[DMN2990UFB-7B](#) [SSM3K35CT,L3F](#) [IPLK60R1K0PFD7ATMA1](#) [2N7002W-G](#) [MCAC30N06Y-TP](#) [IPWS65R035CFD7AXKSA1](#)
[MCQ7328-TP](#) [SSM3J143TU,LXHF](#) [DMN12M3UCA6-7](#) [PJMF280N65E1_T0_00201](#) [PJMF380N65E1_T0_00201](#)
[PJMF280N60E1_T0_00201](#) [PJMF600N65E1_T0_00201](#) [PJMF900N65E1_T0_00201](#)