

N-channel Enhancement mode TO-220F/TO-220FT/TO-251/S/M/TO-252 MOSFET

Features

- High ruggedness
- Low $R_{DS(ON)}$ (Typ 1.9Ω)
@ $V_{GS}=10V$
- Low Gate Charge (Typ 18nC)
- Improved dv/dt Capability
- 100% Avalanche Tested
- Application: Adapter, LED, Charger

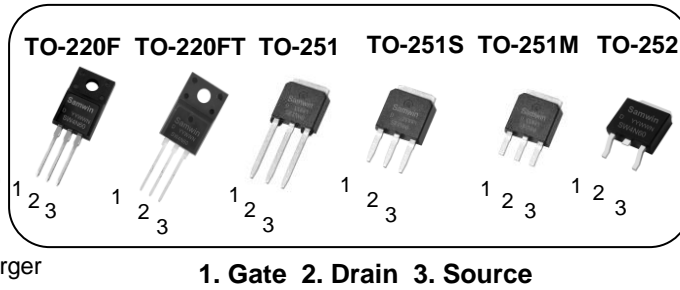

$BV_{DSS} : 600V$

$I_D : 4A$

$R_{DS(ON)} : 1.9\Omega$

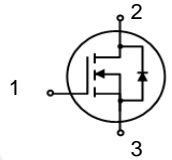

General Description

This power MOSFET is produced with advanced technology of SAMWIN.

This technology enable power MOSFET to have better characteristics, such as fast switching time, low on resistance, low gate charge and especially excellent avalanche characteristics.

Order Codes

Item	Sales Type	Marking	Package	Packaging
1	SW F 4N60D	SW4N60D	TO-220F	TUBE
2	SW Y 4N60D	SW4N60D	TO-220FT	TUBE
3	SW I 4N60D	SW4N60D	TO-251	TUBE
4	SW SI 4N60D	SW4N60D	TO-251S	TUBE
5	SW MI 4N60D	SW4N60D	TO-251M	TUBE
6	SW D 4N60D	SW4N60D	TO-252	REEL



Absolute maximum ratings

Symbol	Parameter	Value			Unit
		TO-220F/TO-220FT	TO-251*	TO-252	
V_{DSS}	Drain to Source Voltage	600			V
I_D	Continuous Drain Current (@ $T_C=25^\circ C$)	4*			A
	Continuous Drain Current (@ $T_C=100^\circ C$)	2.5*			A
I_{DM}	Drain current pulsed (note 1)	16			A
V_{GS}	Gate to Source Voltage	± 30			V
E_{AS}	Single pulsed Avalanche Energy (note 2)	184			mJ
E_{AR}	Repetitive Avalanche Energy (note 1)	55			mJ
dv/dt	Peak diode Recovery dv/dt (note 3)	5			V/ns
P_D	Total power dissipation (@ $T_C=25^\circ C$)	23.5	152.6	141.0	W
	Derating Factor above 25°C	0.19	1.22	1.13	W/°C
T_{STG}, T_J	Operating Junction Temperature & Storage Temperature	-55 ~ + 150			°C
T_L	Maximum Lead Temperature for soldering purpose, 1/8 from Case for 5 seconds.	300			°C

*. Drain current is limited by junction temperature.

Thermal characteristics

Symbol	Parameter	Value			Unit
		TO-220F/TO-220FT	TO-251*	TO-252	
R_{thjc}	Thermal resistance, Junction to case	5.31	0.82	0.89	°C/W
R_{thja}	Thermal resistance, Junction to ambient	47.1	83.5	79.0	°C/W

Electrical characteristic ($T_C = 25^\circ\text{C}$ unless otherwise specified)

Symbol	Parameter	Test conditions	Min.	Typ.	Max.	Unit
Off characteristics						
BV_{DSS}	Drain to source breakdown voltage	$V_{GS}=0V, I_D=250\mu A$	600			V
$\Delta BV_{DSS} / \Delta T_J$	Breakdown voltage temperature coefficient	$I_D=250\mu A$, referenced to 25°C		0.47		$V/^\circ\text{C}$
I_{DSS}	Drain to source leakage current	$V_{DS}=600V, V_{GS}=0V$			1	μA
		$V_{DS}=480V, T_C=125^\circ\text{C}$			50	μA
I_{GSS}	Gate to source leakage current, forward	$V_{GS}=30V, V_{DS}=0V$			100	nA
	Gate to source leakage current, reverse	$V_{GS}=-30V, V_{DS}=0V$			-100	nA
On characteristics						
$V_{GS(TH)}$	Gate threshold voltage	$V_{DS}=V_{GS}, I_D=250\mu A$	2.5		4.5	V
$R_{DS(ON)}$	Drain to source on state resistance	$V_{GS}=10V, I_D=2A$		1.9	2.2	Ω
G_{fs}	Forward Transconductance	$V_{DS}=30V, I_D=2A$		3.5		S
Dynamic characteristics						
C_{iss}	Input capacitance	$V_{GS}=0V, V_{DS}=25V, f=1\text{MHz}$		651		pF
C_{oss}	Output capacitance			70		
C_{rss}	Reverse transfer capacitance			8.4		
$t_{d(on)}$	Turn on delay time	$V_{DS}=300V, I_D=4A, R_G=25\Omega$ (note 4,5)		10		ns
t_r	Rising time			25		
$t_{d(off)}$	Turn off delay time			37		
t_f	Fall time			25		
Q_g	Total gate charge	$V_{DS}=480V, V_{GS}=10V, I_D=4A$ (note 4,5)		18		nC
Q_{gs}	Gate-source charge			3		
Q_{gd}	Gate-drain charge			9		
R_g	Gate resistance	$V_{DS}=0V$, Scan F mode		3.1		Ω

Source to drain diode ratings characteristics

Symbol	Parameter	Test conditions	Min.	Typ.	Max.	Unit
I_S	Continuous source current	Integral reverse p-n Junction diode in the MOSFET			4	A
I_{SM}	Pulsed source current				16	A
V_{SD}	Diode forward voltage drop.	$I_S=4A, V_{GS}=0V$			1.4	V
T_{rr}	Reverse recovery time	$I_S=4A, V_{GS}=0V,$ $di_f/dt=100A/\mu s$		409		ns
Q_{rr}	Reverse recovery Charge				2.3	μC

※. Notes

1. Repetitive rating : pulse width limited by junction temperature.
2. $L = 22.8\text{mH}, I_{AS} = 4A, V_{DD} = 50V, R_G=25\Omega$, Starting $T_J = 25^\circ\text{C}$
3. $I_{SD} \leq 4A, di/dt = 100A/\mu s, V_{DD} \leq BV_{DSS}$, Starting $T_J = 25^\circ\text{C}$
4. Pulse Test : Pulse Width $\leq 300\mu s$, duty cycle $\leq 2\%$.
5. Essentially independent of operating temperature.

Fig. 1. On-state characteristics

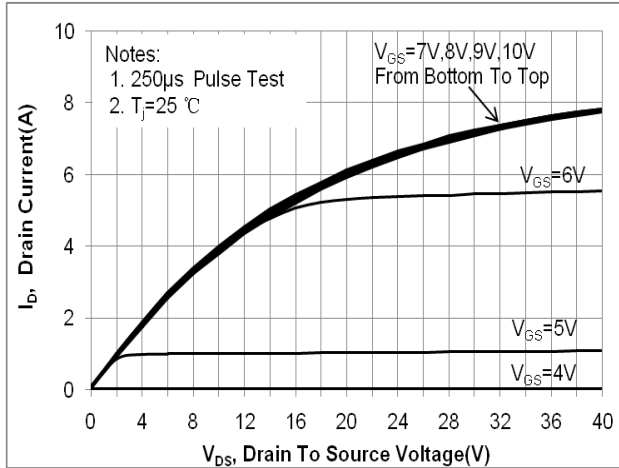

Fig. 2. On-resistance variation vs. drain current and gate voltage

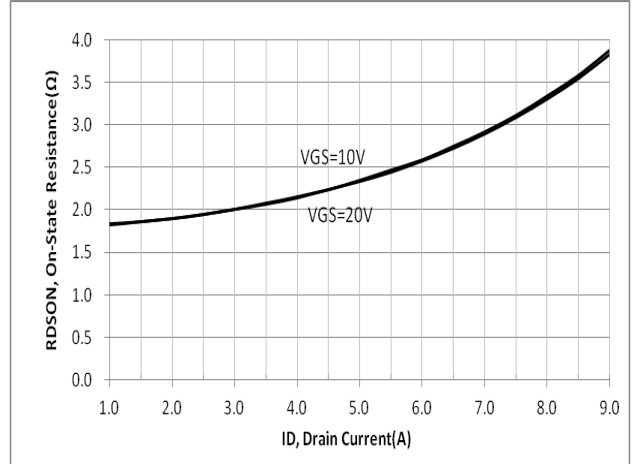

Fig. 3. Gate charge characteristics

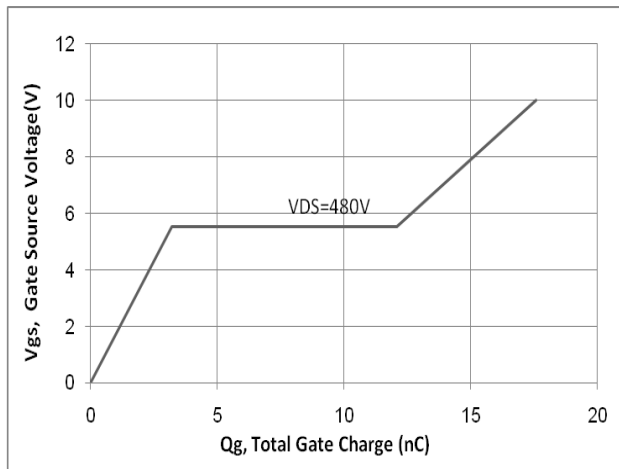

Fig. 4. On state current vs. diode forward voltage

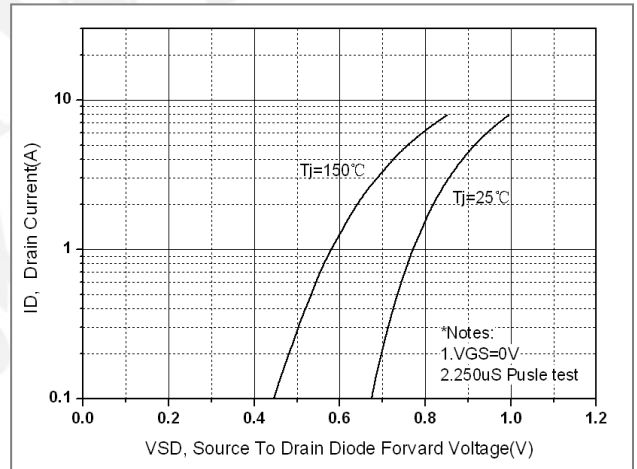

Fig 5. Breakdown Voltage Variation vs. Junction Temperature

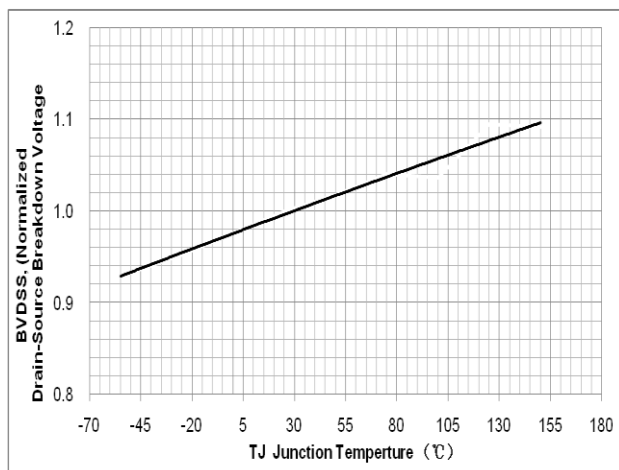

Fig. 6. On resistance variation vs. junction temperature

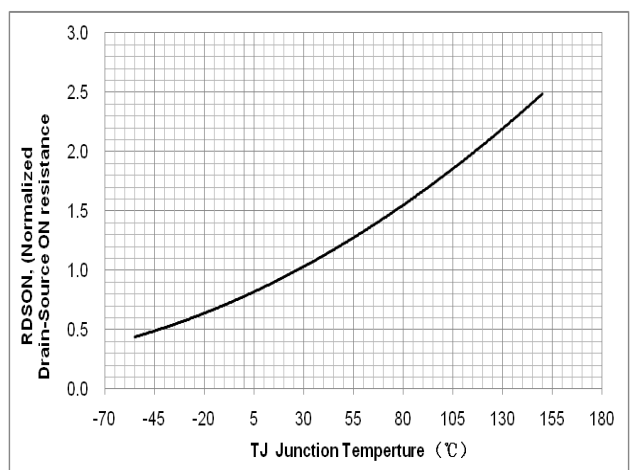

Fig. 7. Maximum safe operating area (TO-220F&TO220FT)

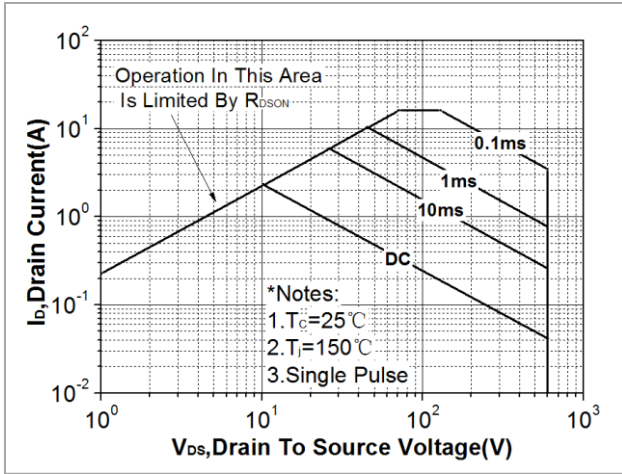

Fig. 8. Maximum safe operating area (TO-251*)

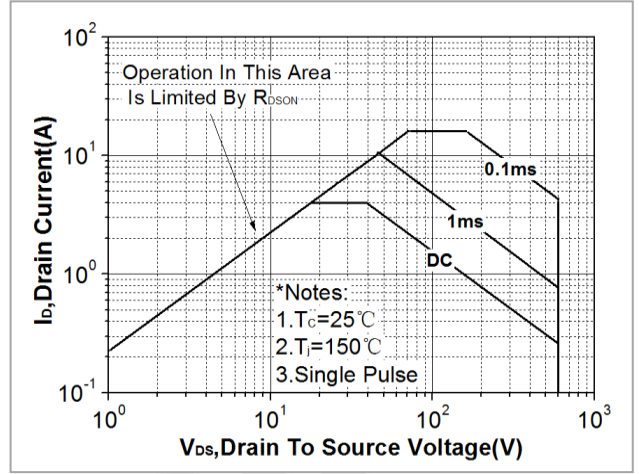

Fig. 9. Maximum safe operating area (TO-252)

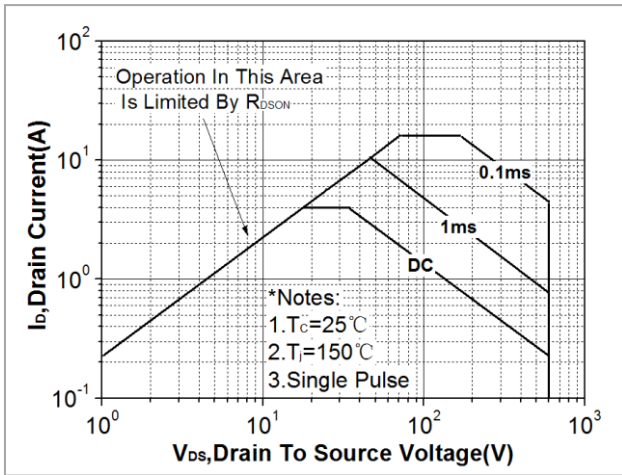

Fig. 10. Capacitance Characteristics

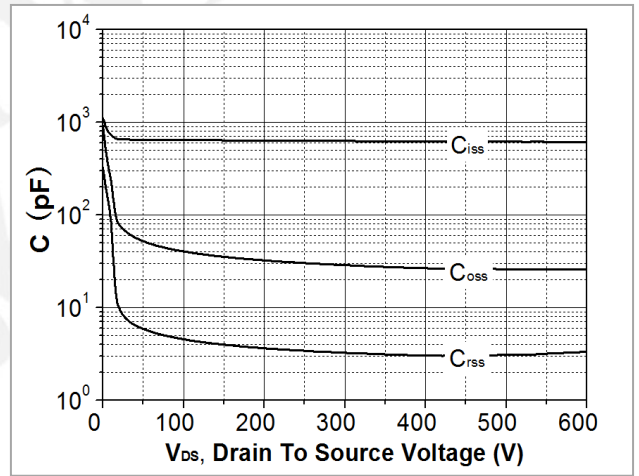

Fig. 11. Transient thermal response curve (TO-220F&TO-220FT)

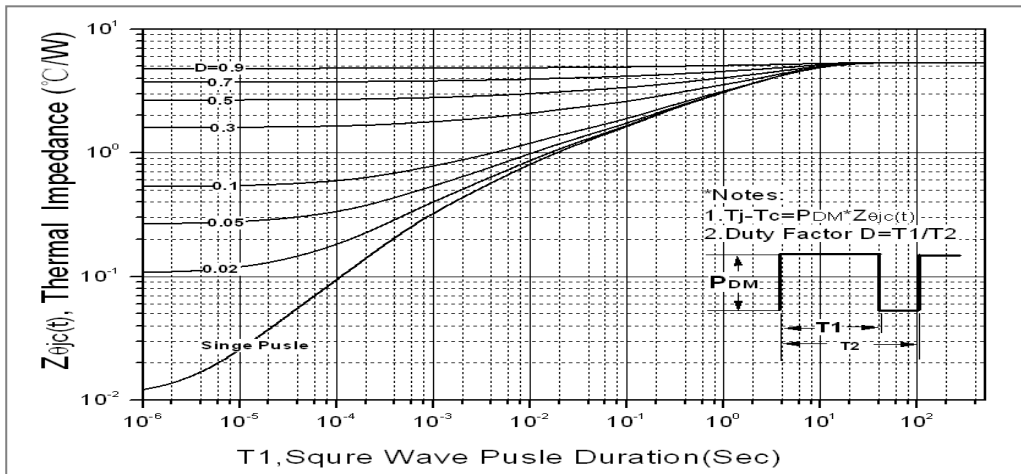

Fig. 12. Transient thermal response curve (TO-251*)

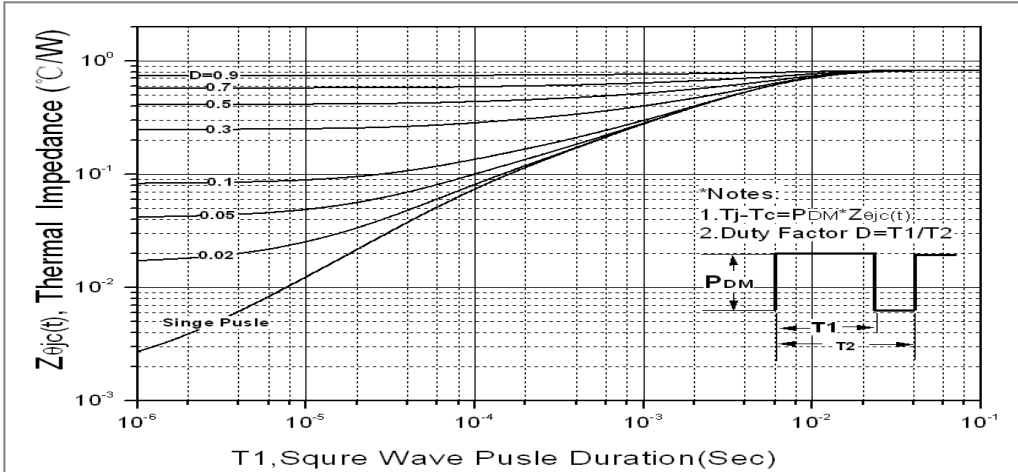

Fig. 13. Transient thermal response curve (TO-252)

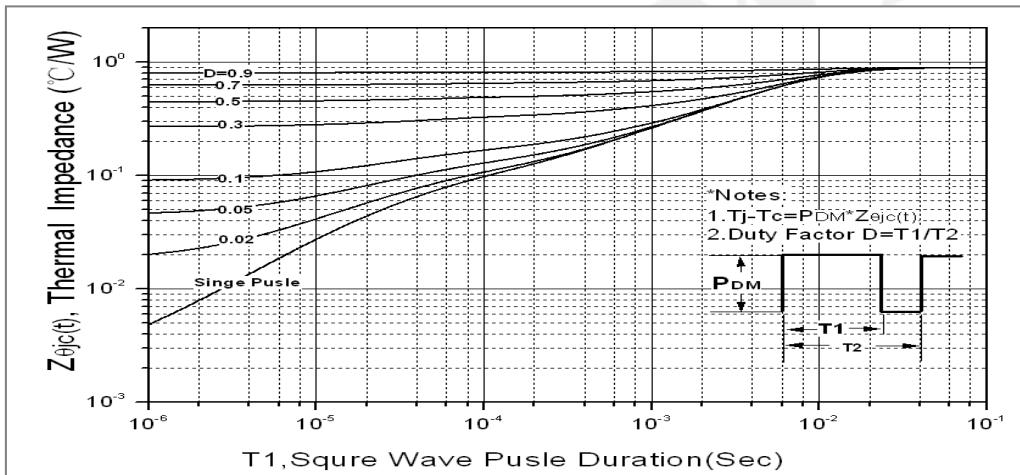

Fig. 14. Gate charge test circuit & waveform

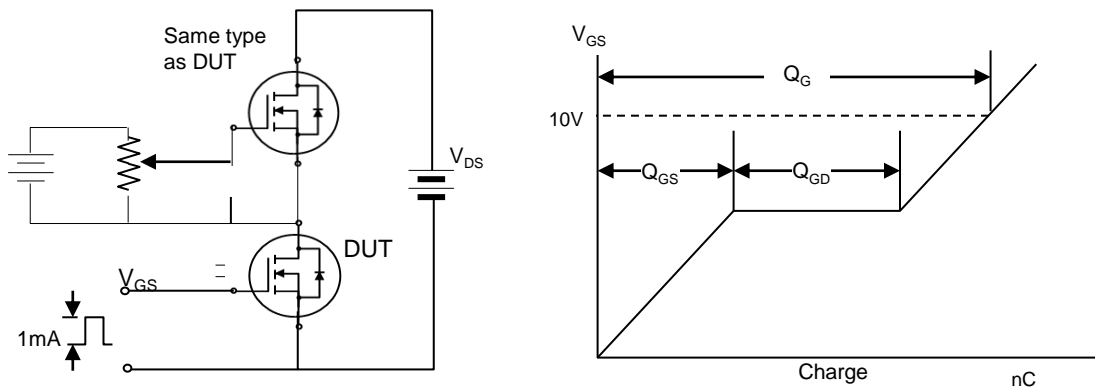

Fig. 15. Switching time test circuit & waveform

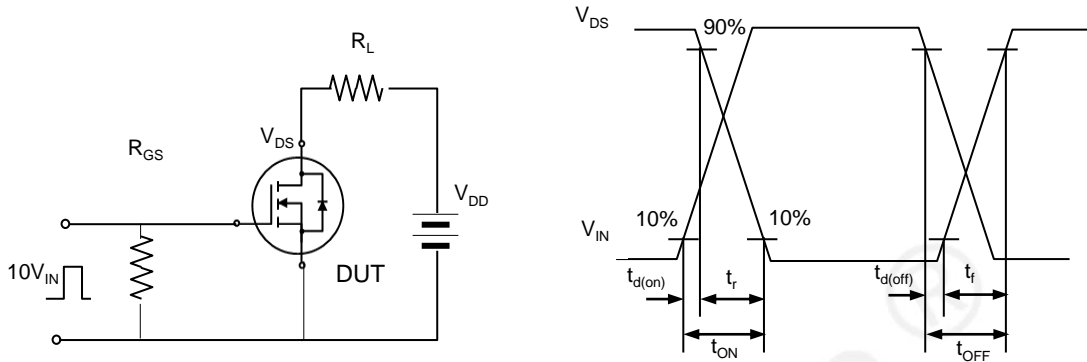

Fig. 16. Unclamped Inductive switching test circuit & waveform

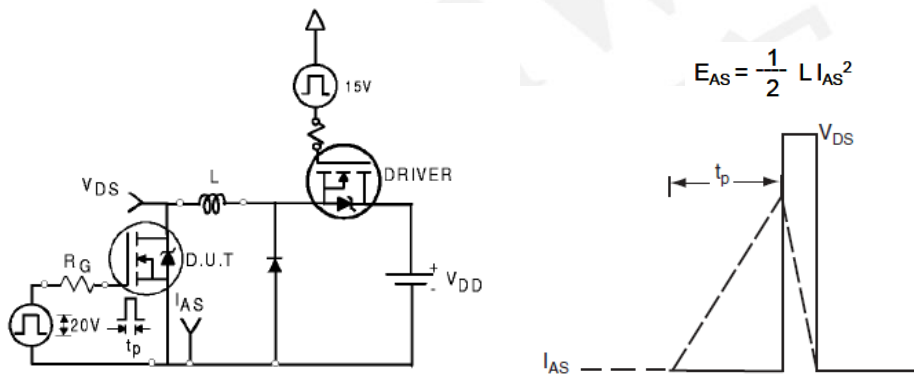
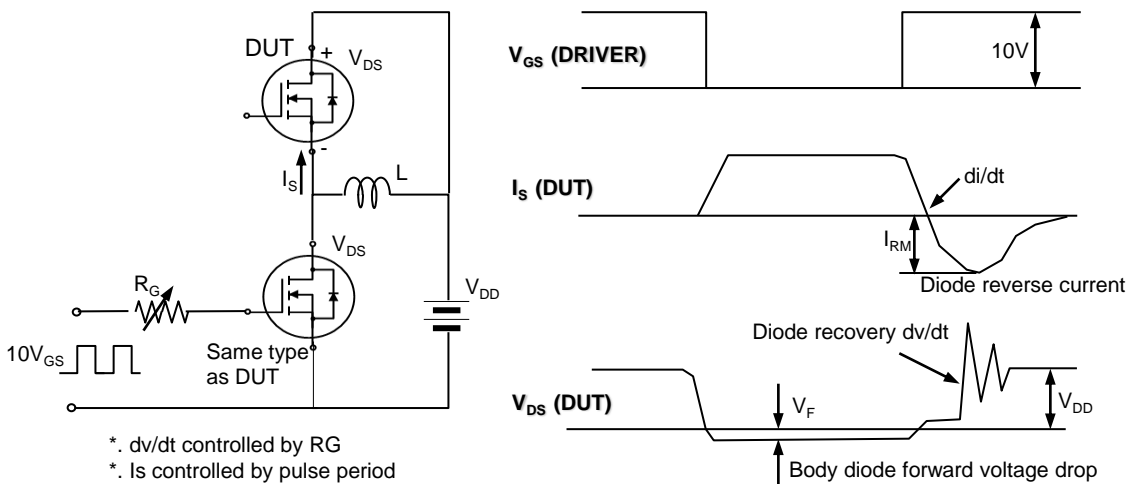



Fig. 17. Peak diode recovery dv/dt test circuit & waveform



Samwin[®]
内部保密

DISCLAIRATION:

- * All the data&curve within this document was tested in SEMIPOWER TESTING&APPLICATION CENTER.
- * This product has passed the PCT,TC,HTRB,HTGB,HAST,PC and Solderdunk reliability testing.
- * Qualification Standards can also be found on the Web site (<http://www.semipower.com.cn>) 
- * Any advice, please send your proposal to samwin@samwinsemi.com

X-ON Electronics

Largest Supplier of Electrical and Electronic Components

Click to view similar products for [MOSFET](#) category:

Click to view products by [Sam&wing](#) manufacturer:

Other Similar products are found below :

[IRFD120](#) [JANTX2N5237](#) [2SK2267\(Q\)](#) [BUK455-60A/B](#) [TK100A10N1,S4X\(S](#) [MIC4420CM-TR](#) [VN1206L](#) [NDP4060](#) [SI4482DY](#)
[IRS2092STRPBF-EL](#) [IPS70R2K0CEAKMA1](#) [TK31J60W5,S1VQ\(O](#) [TK31J60W,S1VQ\(O](#) [TK16J60W,S1VQ\(O](#) [2SK2614\(TE16L1,Q\)](#)
[DMN1017UCP3-7](#) [EFC2J004NUZTDG](#) [P85W28HP2F-7071](#) [NTE2384](#) [DMC2700UDMQ-7](#) [DMN2080UCB4-7](#) [DMN61D9UWQ-13](#)
[US6M2GTR](#) [DMN31D5UDJ-7](#) [DMP22D4UFO-7B](#) [IPS60R3K4CEAKMA1](#) [DMN1006UCA6-7](#) [DMN16M9UCA6-7](#) [STF5N65M6](#)
[IRF40H233XTMA1](#) [STU5N65M6](#) [DMN6022SSD-13](#) [DMN13M9UCA6-7](#) [DMTH10H4M6SPS-13](#) [IPS60R360PFD7SAKMA1](#)
[DMN2990UFB-7B](#) [SSM3K35CT,L3F](#) [IPLK60R1K0PFD7ATMA1](#) [2N7002W-G](#) [MCAC30N06Y-TP](#) [IPWS65R035CFD7AXKSA1](#)
[MCQ7328-TP](#) [SSM3J143TU,LXHF](#) [DMN12M3UCA6-7](#) [PJMF280N65E1_T0_00201](#) [PJMF380N65E1_T0_00201](#)
[PJMF280N60E1_T0_00201](#) [PJMF600N65E1_T0_00201](#) [PJMF900N65E1_T0_00201](#) [PJMF900N60E1_T0_00201](#)