

## N-channel Enhanced mode TO-220F/TO-251N/TO-251S/TO-251M/TO-251U/ TO-252/SOT-82/TO-263 /TO-220/TO-251MQ MOSFET

### Features

- High ruggedness
- Low  $R_{DS(ON)}$  (Typ  $2\Omega$ )@ $V_{GS}=10V$
- Low Gate Charge (Typ  $18nC$ )
- Improved dv/dt Capability
- 100% Avalanche Tested
- Application: Charger,TV-POWER

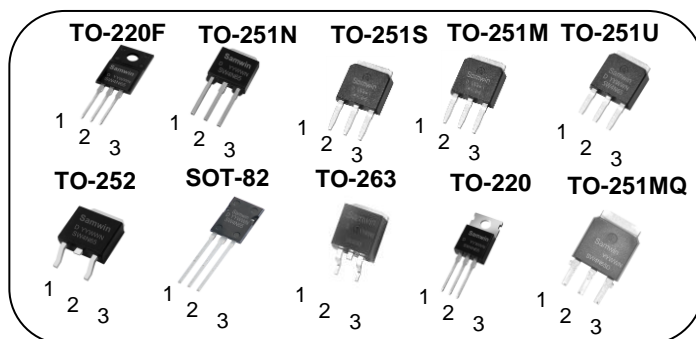

$BV_{DSS} : 650V$

$I_D : 4A$

$R_{DS(ON)} : 2\Omega$

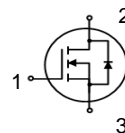

### General Description

This power MOSFET is produced with advanced technology of SAMWIN.

This technology enable the power MOSFET to have better characteristics, including fast switching time, low on resistance, low gate charge and especially excellent avalanche characteristics.

### Order Codes

Item	Sales Type	Marking	Package	Packaging
1	SW F 4N65D	SW4N65D	TO-220F	TUBE
2	SW N 4N65D	SW4N65D	TO-251N	TUBE
3	SW SI 4N65D	SW4N65D	TO-251S	TUBE
4	SW MI 4N65D	SW4N65D	TO-251M	TUBE
5	SW UI 4N65D	SW4N65D	TO-251U	TUBE
6	SW D 4N65D	SW4N65D	TO-252	REEL
7	SW S 4N65D	SW4N65D	SOT-82	TUBE
8	SW B 4N65D	SW4N65D	TO-263	TUBE
9	SW P 4N65D	SW4N65D	TO-220	TUBE
10	SW MQI 4N65D	SW4N65D	TO-251MQ	TUBE

1. Gate 2. Drain 3. Source



### Absolute maximum ratings

Symbol	Parameter	Value					Unit
		TO220F	TO251N/S/M/U&TO252&TO-251MQ	SOT82	TO263	TO220	
$V_{DSS}$	Drain to source voltage	650					V
$I_D$	Continuous drain current (@ $T_C=25^\circ C$ )	4*					A
	Continuous drain current (@ $T_C=100^\circ C$ )	2.5*					A
$I_{DM}$	Drain current pulsed (note 1)	16					A
$V_{GS}$	Gate to source voltage	$\pm 30$					V
$E_{AS}$	Single pulsed avalanche energy (note2)	246					mJ
$E_{AR}$	Repetitive avalanche energy (note 1)	15					mJ
dv/dt	Peak diode recovery dv/dt (note 3)	5					V/ns
$P_D$	Total power dissipation (@ $T_C=25^\circ C$ )	23	101	145	156	167	W
	Derating factor above $25^\circ C$	0.19	0.81	1.16	1.25	1.33	W/ $^\circ C$
$T_{STG}, T_J$	Operating junction temperature & storage temperature	-55 ~ + 150					$^\circ C$
$T_L$	Maximum lead temperature for soldering purpose, 1/8 from case for 5 seconds.	300					$^\circ C$

\*. Drain current is limited by junction temperature.

### Thermal characteristics

Symbol	Parameter	Value					Unit
		TO220F	TO251N/S/M/U&TO252&TO-251MQ	SOT82	TO263	TO220	
$R_{thjc}$	Thermal resistance, Junction to case	5.36	1.24	0.86	0.80	0.75	$^\circ C/W$
$R_{thja}$	Thermal resistance, Junction to ambient	49	66	81		61	$^\circ C/W$

Electrical characteristic (  $T_C = 25^\circ\text{C}$  unless otherwise specified )

Symbol	Parameter	Test conditions	Min.	Typ.	Max.	Unit
<b>Off characteristics</b>						
$BV_{DSS}$	Drain to source breakdown voltage	$V_{GS}=0V, I_D=250\mu A$	650			V
$\Delta BV_{DSS} / \Delta T_J$	Breakdown voltage temperature coefficient	$I_D=250\mu A$ , referenced to $25^\circ\text{C}$		0.48		$V/^\circ\text{C}$
$I_{DSS}$	Drain to source leakage current	$V_{DS}=650V, V_{GS}=0V$			1	$\mu A$
		$V_{DS}=520V, T_C=125^\circ\text{C}$			50	$\mu A$
$I_{GSS}$	Gate to source leakage current, forward	$V_{GS}=30V, V_{DS}=0V$			100	nA
	Gate to source leakage current, reverse	$V_{GS}=-30V, V_{DS}=0V$			-100	nA
<b>On characteristics</b>						
$V_{GS(TH)}$	Gate threshold voltage	$V_{DS}=V_{GS}, I_D=250\mu A$	2.5		4.5	V
$R_{DS(ON)}$	Drain to source on state resistance	$V_{GS}=10V, I_D=2A$		2	2.6	$\Omega$
$G_{fs}$	Forward transconductance	$V_{DS}=30V, I_D=2A$		3.8		S
<b>Dynamic characteristics</b>						
$C_{iss}$	Input capacitance	$V_{GS}=0V, V_{DS}=25V, f=1\text{MHz}$		758		pF
$C_{oss}$	Output capacitance			69		
$C_{rss}$	Reverse transfer capacitance			8		
$t_{d(on)}$	Turn on delay time	$V_{DS}=325V, V_{GS}=10V, I_D=4A,$ $R_G=25\Omega$ (note 4,5)		15		ns
$t_r$	Rising time			26		
$t_{d(off)}$	Turn off delay time			43		
$t_f$	Fall time			26		
$Q_g$	Total gate charge	$V_{DS}=520V, V_{GS}=10V, I_D=4A$ (note 4,5)		18		nC
$Q_{gs}$	Gate-source charge			4		
$Q_{gd}$	Gate-drain charge			8		
$R_g$	Gate resistance	$V_{DS}=0V$ , Scan F mode		3.2		$\Omega$

### Source to drain diode ratings characteristics

Symbol	Parameter	Test conditions	Min.	Typ.	Max.	Unit
$I_S$	Continuous source current	Integral reverse p-n Junction diode in the MOSFET			4	A
$I_{SM}$	Pulsed source current				16	A
$V_{SD}$	Diode forward voltage drop.	$I_S=4A, V_{GS}=0V$			1.4	V
$t_{rr}$	Reverse recovery time	$I_S=4A, V_{GS}=0V,$ $di_F/dt=100A/\mu s$		398		ns
$Q_{rr}$	Reverse recovery charge				2.1	$\mu C$

※. Notes

1. Repetitive rating : pulse width limited by junction temperature.
2.  $L = 30.8\text{mH}, I_{AS} = 4A, V_{DD} = 50V, R_G=25\Omega$ , Starting  $T_J = 25^\circ\text{C}$
3.  $I_{SD} \leq 4A, di/dt = 100A/\mu s, V_{DD} \leq BV_{DSS}$ , Starting  $T_J = 25^\circ\text{C}$
4. Pulse Test : Pulse Width  $\leq 300\mu s$ , duty cycle  $\leq 2\%$ .
5. Essentially independent of operating temperature.

**Fig. 1. On-state characteristics**

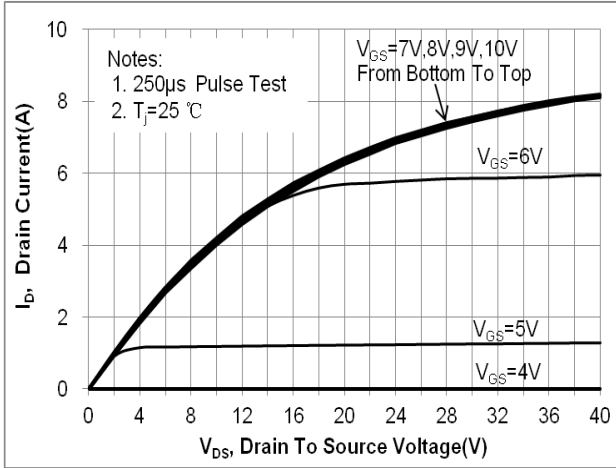

**Fig. 2. Transfer Characteristics**

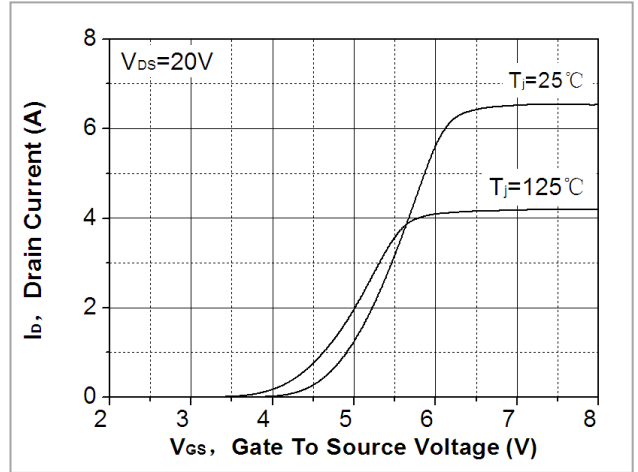

**Fig. 3. On-resistance variation vs. drain current and gate voltage**

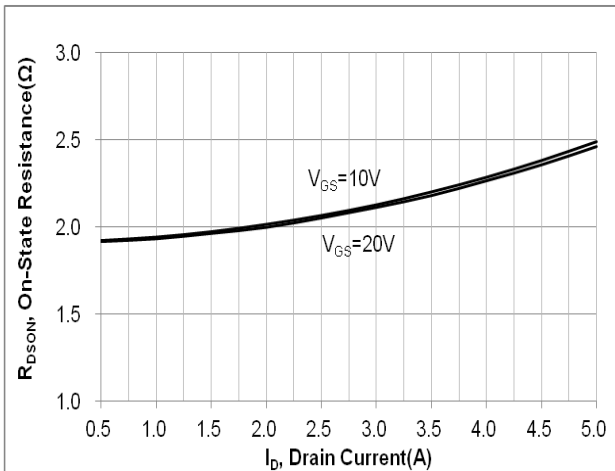

**Fig. 4. On-state current vs. diode forward voltage**

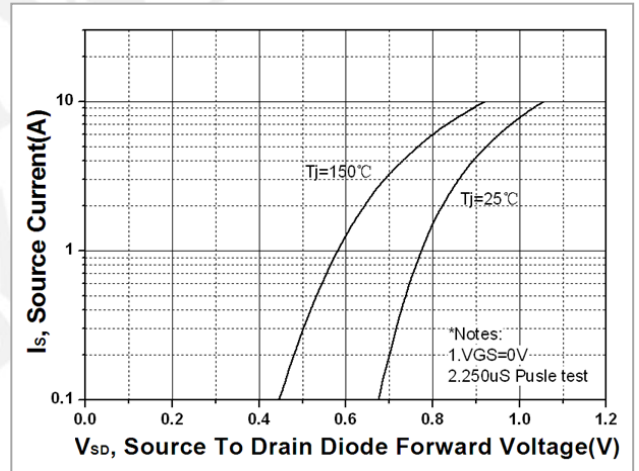

**Fig 5. Breakdown voltage variation vs. junction temperature**

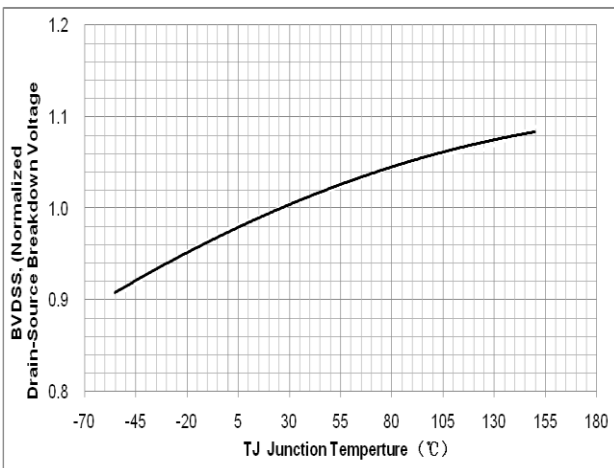

**Fig. 6. On-resistance variation vs. junction temperature**

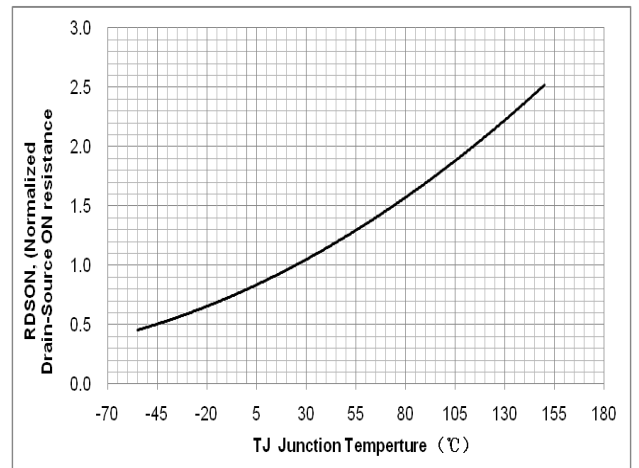

Fig. 7. Gate charge characteristics

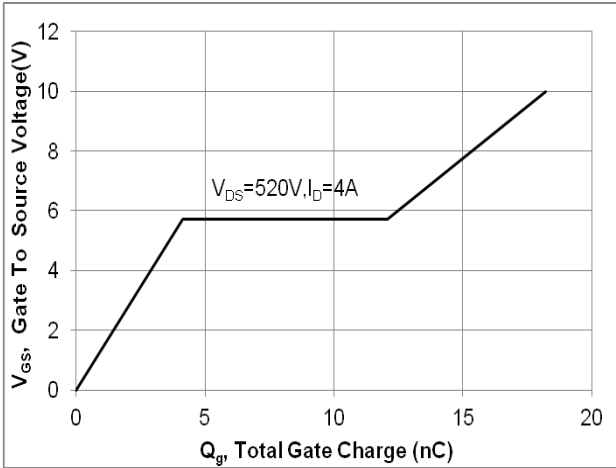

Fig. 8. Capacitance Characteristics

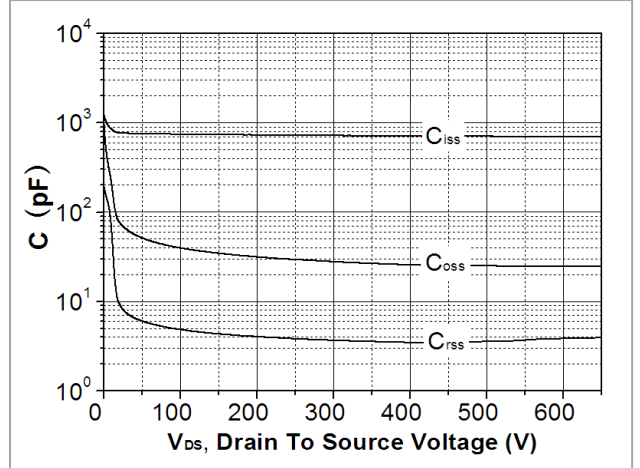

Fig. 9. Maximum safe operating area (TO-220F)

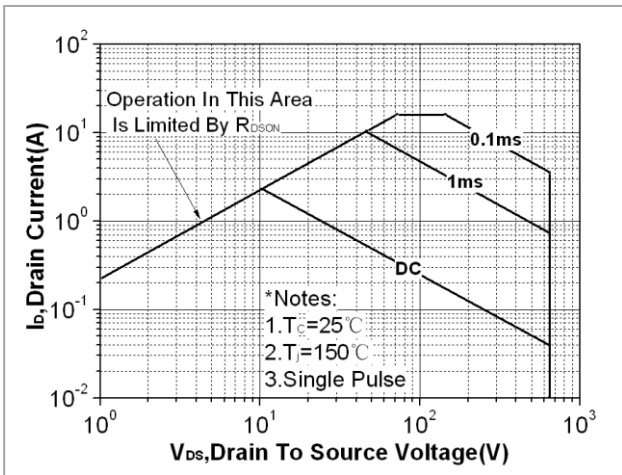

Fig. 10. Maximum safe operating area (TO-251N & TO-251S & TO-251M & TO-251U & TO-252 & TO-251MQ)

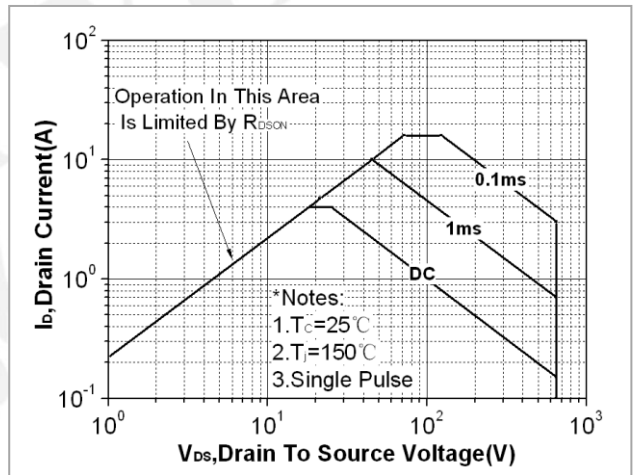

Fig. 11. Maximum safe operating area (SOT-82)

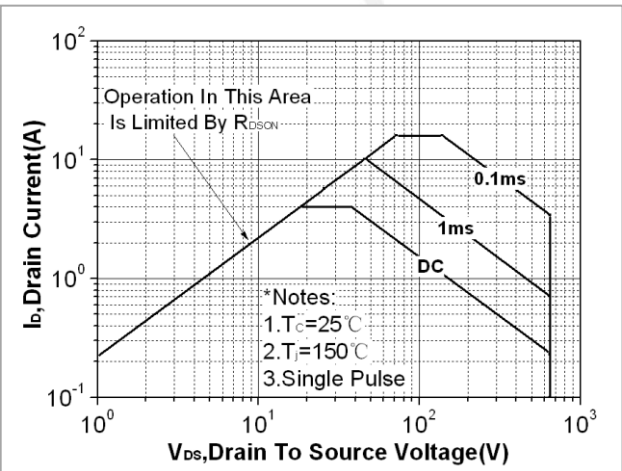

Fig. 12. Maximum safe operating area (TO-263)

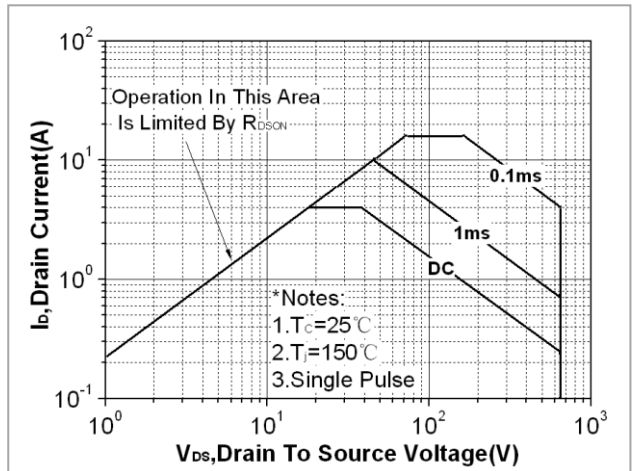

Fig. 13. Maximum safe operating area (TO-220)

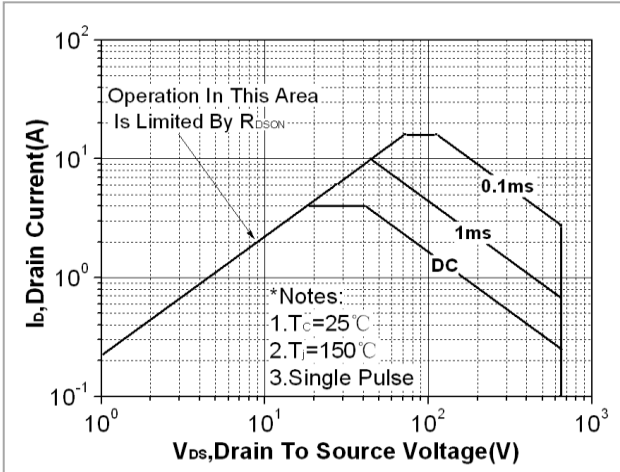

Fig. 14. Transient thermal response curve (TO-220F)

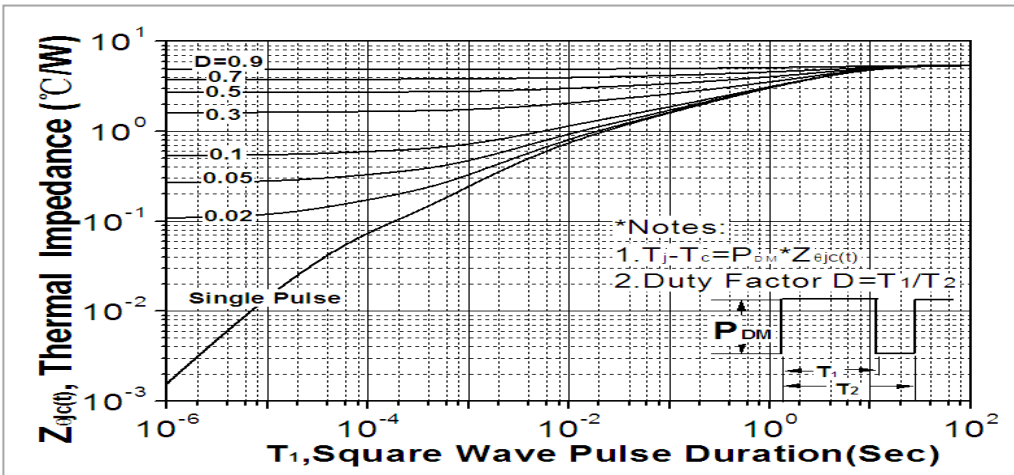

Fig. 15. Transient thermal response curve (TO-251N&TO-251S&TO-251M&TO-251U&TO-252&TO-251MQ)

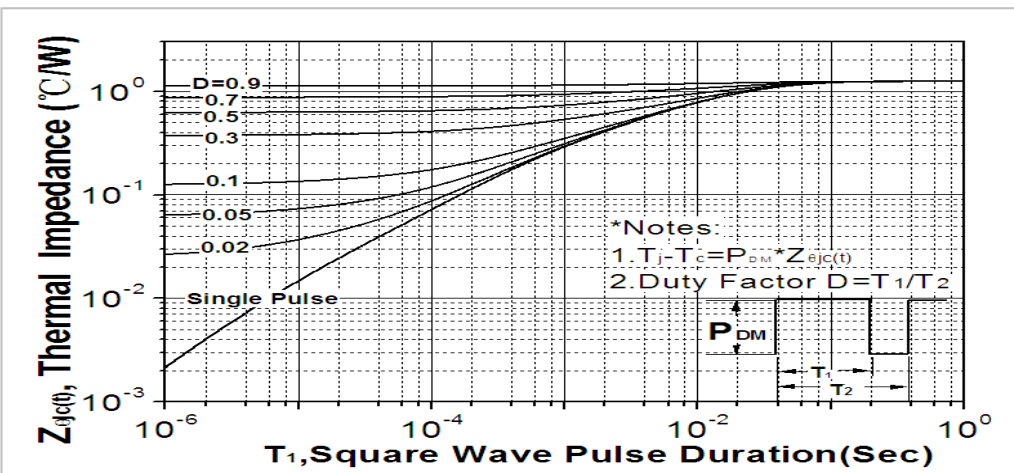

Fig. 16. Transient thermal response curve (SOT-82)

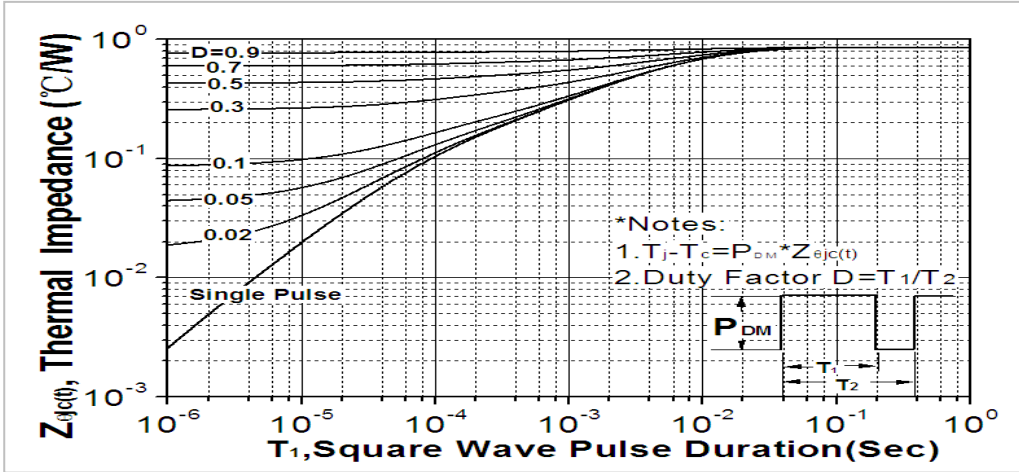

Fig. 17. Transient thermal response curve (TO-263)

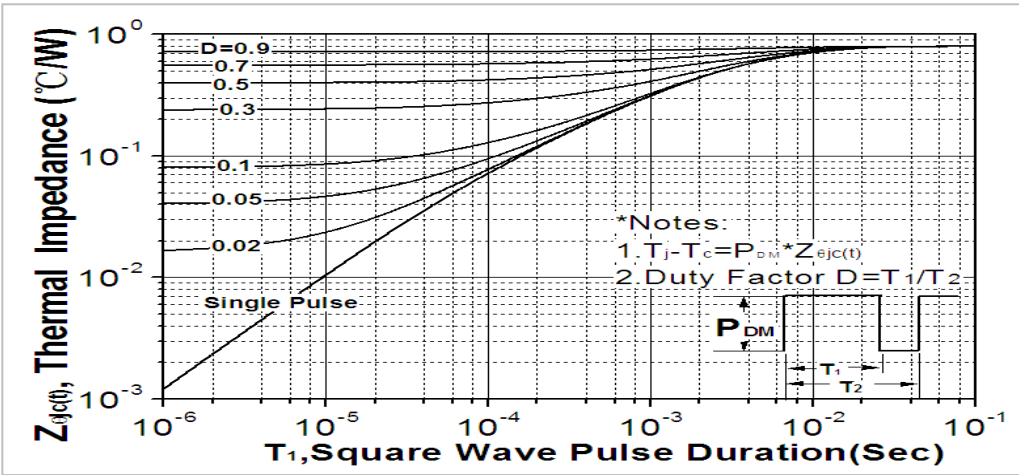
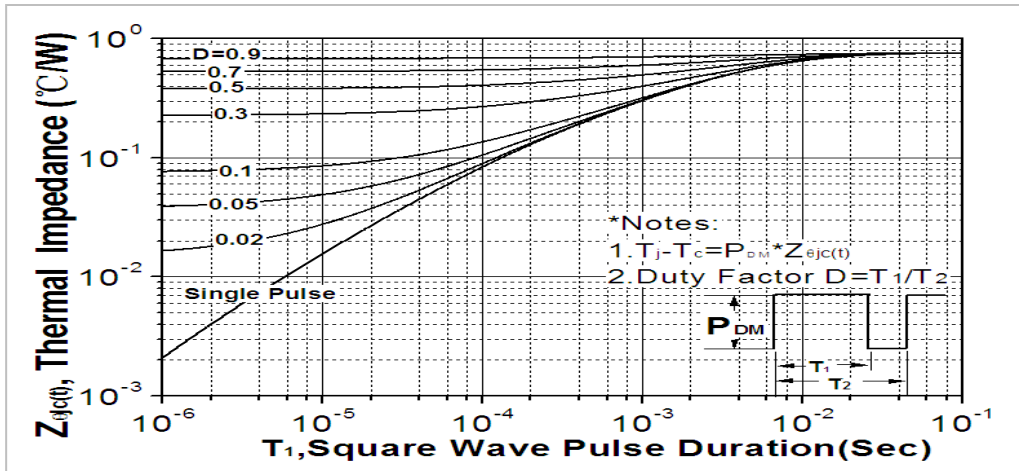
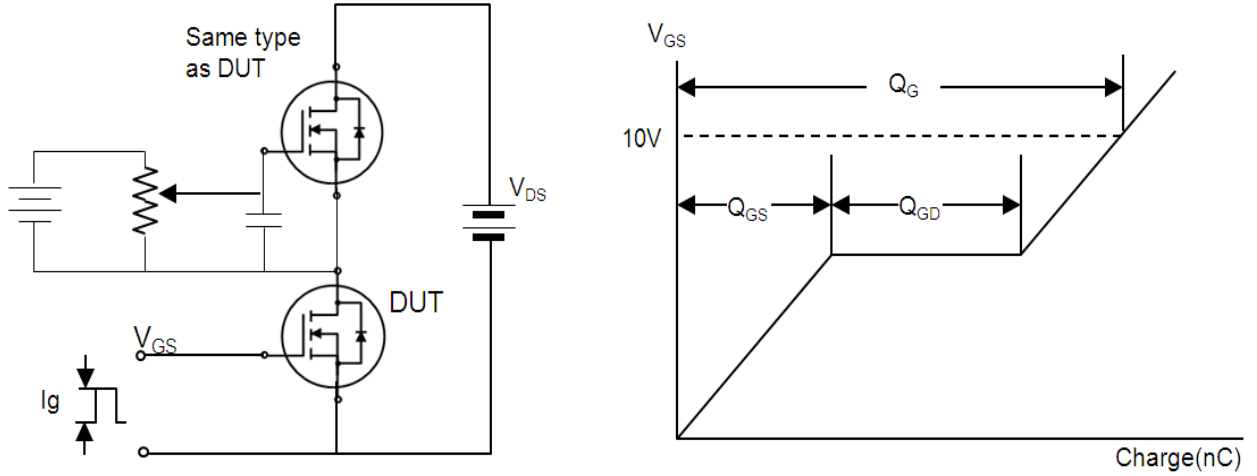

Fig. 18. Transient thermal response curve (TO-220)



**Fig. 19. Gate charge test circuit & waveform**



**Fig. 20. Switching time test circuit & waveform**

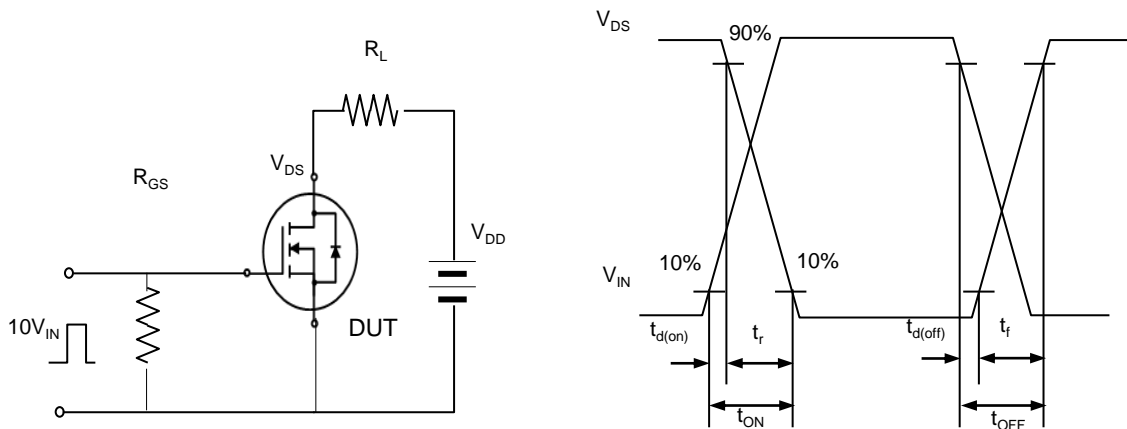

**Fig. 21. Unclamped Inductive switching test circuit & waveform**

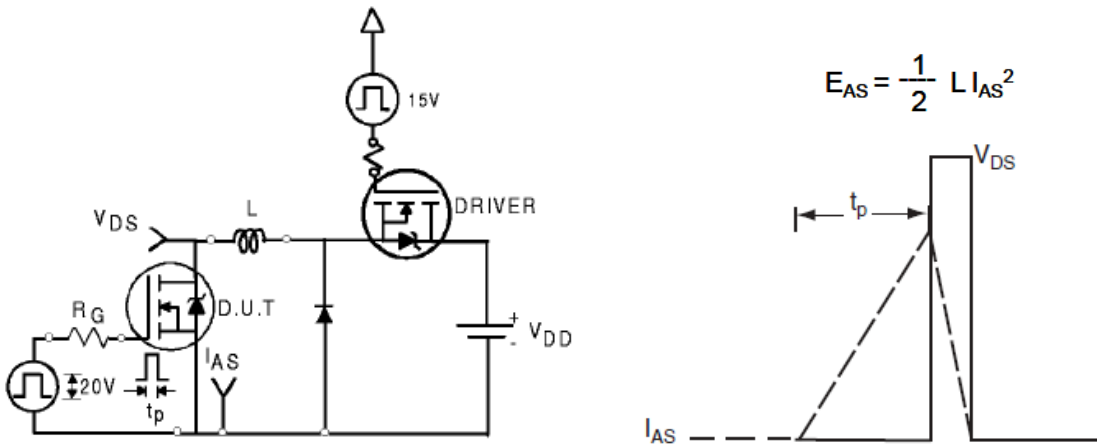
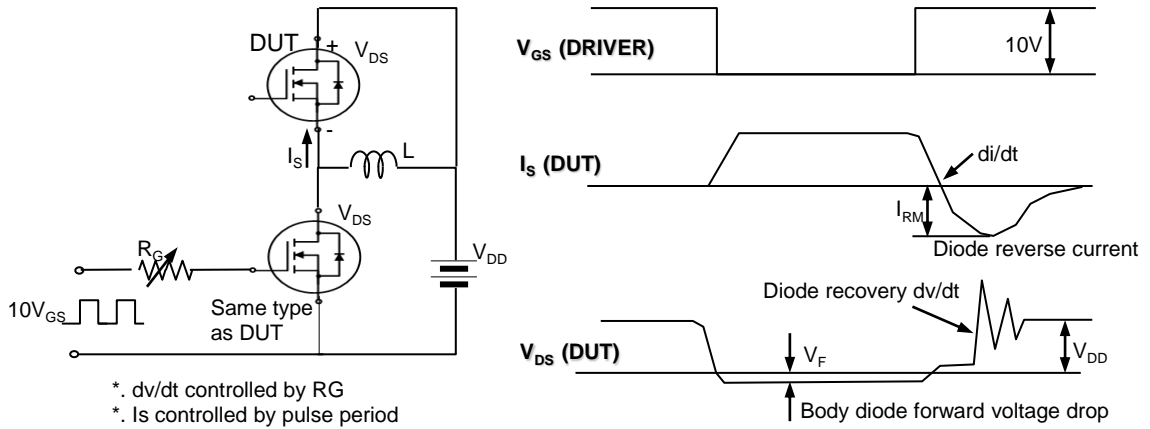





Fig. 22. Peak diode recovery dv/dt test circuit & waveform



## DISCLAIMER

- \* All the data & curve in this document was tested in SEMIPOWER TESTING & APPLICATION CENTER.
- \* This product has passed the PCT,TC,HTRB,HTGB,HAST,PC and Solderdunk reliability testing.
- \* Qualification standards can also be found on the Web site (<http://www.semipower.com.cn>) 
- \* Suggestions for improvement are appreciated, Please send your suggestions to [samwin@samwinsemi.com](mailto:samwin@samwinsemi.com)



## X-ON Electronics

Largest Supplier of Electrical and Electronic Components

*Click to view similar products for [MOSFET](#) category:*

*Click to view products by [Sam&wing](#) manufacturer:*

Other Similar products are found below :

[IRFD120](#) [JANTX2N5237](#) [2SK2267\(Q\)](#) [BUK455-60A/B](#) [TK100A10N1,S4X\(S](#) [MIC4420CM-TR](#) [VN1206L](#) [NDP4060](#) [SI4482DY](#)  
[IRS2092STRPBF-EL](#) [IPS70R2K0CEAKMA1](#) [TK31J60W5,S1VQ\(O](#) [TK31J60W,S1VQ\(O](#) [TK16J60W,S1VQ\(O](#) [2SK2614\(TE16L1,Q\)](#)  
[DMN1017UCP3-7](#) [EFC2J004NUZTDG](#) [P85W28HP2F-7071](#) [DMN1053UCP4-7](#) [NTE2384](#) [DMC2700UDMQ-7](#) [DMN2080UCB4-7](#)  
[DMN61D9UWQ-13](#) [US6M2GTR](#) [DMN31D5UDJ-7](#) [DMP22D4UFO-7B](#) [IPS60R3K4CEAKMA1](#) [DMN1006UCA6-7](#) [DMN16M9UCA6-7](#)  
[STF5N65M6](#) [IRF40H233XTMA1](#) [STU5N65M6](#) [DMN6022SSD-13](#) [DMN13M9UCA6-7](#) [DMTH10H4M6SPS-13](#) [IPS60R360PFD7SAKMA1](#)  
[DMN2990UFB-7B](#) [SSM3K35CT,L3F](#) [IPLK60R1K0PFD7ATMA1](#) [2N7002W-G](#) [MCAC30N06Y-TP](#) [IPWS65R035CFD7AXKSA1](#)  
[MCQ7328-TP](#) [SSM3J143TU,LXHF](#) [DMN12M3UCA6-7](#) [PJMF280N65E1\\_T0\\_00201](#) [PJMF380N65E1\\_T0\\_00201](#)  
[PJMF280N60E1\\_T0\\_00201](#) [PJMF600N65E1\\_T0\\_00201](#) [PJMF900N65E1\\_T0\\_00201](#)