

### Features

- High ruggedness
- Low  $R_{DS(ON)}$  (Typ 2.5m $\Omega$ )@ $V_{GS}=4.5V$   
(Typ 1.6m $\Omega$ )@ $V_{GS}=10V$
- Low Gate Charge (Typ 153nC)
- Improved dv/dt Capability
- 100% Avalanche Tested
- Application: Synchronous Rectification, Li Battery Protect Board, Inverter

### N-channel Enhanced mode DFN5\*6 MOSFET

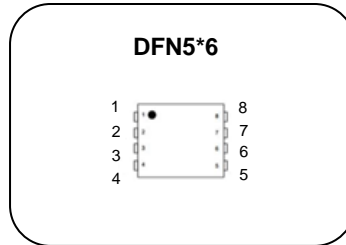

4. Gate 5,6,7,8.Drain 1,2,3.Source

$BV_{DSS}$  : 30V  
 $I_D$  : 120A  
 $R_{DS(ON)}$  : 2.5m $\Omega$ @ $V_{GS}=4.5V$   
 1.6m $\Omega$ @ $V_{GS}=10V$

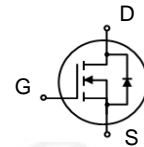

### General Description

This power MOSFET is produced with advanced technology of SAMWIN. This technology enable the power MOSFET to have better characteristics, including fast switching time, low on resistance, low gate charge and especially excellent avalanche characteristics.

### Order Codes

Item	Sales Type	Marking	Package	Packaging
1	SW HA 018R03VLT	SW018R03VLT	DFN5*6	REEL



### Absolute maximum ratings

Symbol	Parameter	Value	Unit
$V_{DSS}$	Drain to source voltage	30	V
$I_D$	Continuous drain current (@ $T_c=25^\circ C$ )	120*	A
	Continuous drain current (@ $T_c=100^\circ C$ )	86*	A
$I_{DM}$	Drain current pulsed (note 1)	480	A
$I_{DSM}$	Continuous drain current (@ $T_a=25^\circ C$ )	33	A
	Continuous drain current (@ $T_a=70^\circ C$ )	26	A
$V_{GS}$	Gate to source voltage	$\pm 20$	V
$E_{AS}$	Single pulsed avalanche energy (note 2)	576	mJ
$E_{AR}$	Repetitive avalanche energy (note 1)	57	mJ
dv/dt	Peak diode recovery dv/dt (note 3)	5	V/ns
$P_D$	Total power dissipation (@ $T_c=25^\circ C$ )	43	W
	Total power dissipation (@ $T_a=25^\circ C$ )	2.6	W
$T_{STG}, T_J$	Operating junction temperature & storage temperature	-55 ~ + 150	$^\circ C$

\*. Drain current is limited by junction temperature.

### Thermal characteristics

Symbol	Parameter	Value	Unit
$R_{thjc}$	Thermal resistance, Junction to case	2.9	$^\circ C/W$
$R_{thja}$	Thermal resistance, Junction to ambient	49	$^\circ C/W$

Note:  $R_{thja}$  is the sum of the junction-to-case and case-to-ambient thermal resistance where the case thermal reference is defined as the solder mounting surface of the drain pins.  $R_{thjc}$  is guaranteed by design while  $R_{thca}$  is determined by the user's board design.



DFN5\*6  $R_{thja}$  : 49 $^\circ C/W$  on a 1 in<sup>2</sup> pad of 2oz copper.

## Electrical characteristic ( $T_J = 25^\circ\text{C}$ unless otherwise specified )

Symbol	Parameter	Test conditions	Min.	Typ.	Max.	Unit
<b>Off characteristics</b>						
$BV_{DSS}$	Drain to source breakdown voltage	$V_{GS}=0V, I_D=250\mu A$	30			V
$\Delta BV_{DSS} / \Delta T_J$	Breakdown voltage temperature coefficient	$I_D=250\mu A$ , referenced to $25^\circ\text{C}$		0.02		V/ $^\circ\text{C}$
$I_{DSS}$	Drain to source leakage current	$V_{DS}=30V, V_{GS}=0V$			1	$\mu A$
		$V_{DS}=24V, T_J=125^\circ\text{C}$			50	$\mu A$
$I_{GSS}$	Gate to source leakage current, forward	$V_{GS}=20V, V_{DS}=0V$			100	nA
	Gate to source leakage current, reverse	$V_{GS}=-20V, V_{DS}=0V$			-100	nA
<b>On characteristics</b>						
$V_{GS(TH)}$	Gate threshold voltage	$V_{DS}=V_{GS}, I_D=250\mu A$	1.2		2.4	V
$R_{DS(ON)}$	Drain to source on state resistance	$V_{GS}=4.5V, I_D=30A, T_J=25^\circ\text{C}$		2.5	3.5	m $\Omega$
		$V_{GS}=10V, I_D=30A, T_J=25^\circ\text{C}$		1.6	2.4	m $\Omega$
		$V_{GS}=10V, I_D=30A, T_J=125^\circ\text{C}$		2.1		m $\Omega$
$G_{fs}$	Forward transconductance	$V_{DS}=5V, I_D=30A$		79		S
<b>Dynamic characteristics</b>						
$C_{iss}$	Input capacitance	$V_{GS}=0V, V_{DS}=15V, f=1\text{MHz}$		5772		pF
$C_{oss}$	Output capacitance			1104		
$C_{riss}$	Reverse transfer capacitance			760		
$t_{d(on)}$	Turn on delay time	$V_{DS}=15V, I_D=30A, R_G=4.7\Omega, V_{GS}=10V$ (note 4,5)		20		ns
$t_r$	Rising time			47		
$t_{d(off)}$	Turn off delay time			137		
$t_f$	Fall time			69		
$Q_g$	Total gate charge	$V_{DS}=24V, V_{GS}=10V, I_D=30A, I_G=5\text{mA}$ (note 4,5)		153		nC
$Q_{gs}$	Gate-source charge			18		
$Q_{gd}$	Gate-drain charge			44		
$R_g$	Gate resistance	$V_{DS}=0V$ , Scan F mode		3.1		$\Omega$

## Source to drain diode ratings characteristics

Symbol	Parameter	Test conditions	Min.	Typ.	Max.	Unit
$I_S$	Continuous source current	Integral reverse p-n Junction diode in the MOSFET			120	A
$I_{SM}$	Pulsed source current				480	A
$V_{SD}$	Diode forward voltage drop.	$I_S=45A, V_{GS}=0V$			1.4	V
$t_{rr}$	Reverse recovery time	$I_S=30A, V_{GS}=0V, di/dt=100A/\mu s$		31		ns
$Q_{rr}$	Reverse recovery charge			16		nC

### ※. Notes

1. Repeattive rating : pulse width limited by junction temperature.
2.  $L=0.5\text{mH}, I_{AS}=48A, V_{DD}=30V, R_G=25\Omega$ , Starting  $T_J=25^\circ\text{C}$
3.  $I_{SD} \leq 30A, di/dt = 100A/\mu s, V_{DD} \leq BV_{DSS}$ , Starting  $T_J=25^\circ\text{C}$
4. Pulse Test : Pulse Width  $\leq 300\mu s$ , duty cycle  $\leq 2\%$ .
5. Essentially independent of operating temperature.

**Fig. 1. On-state characteristics**

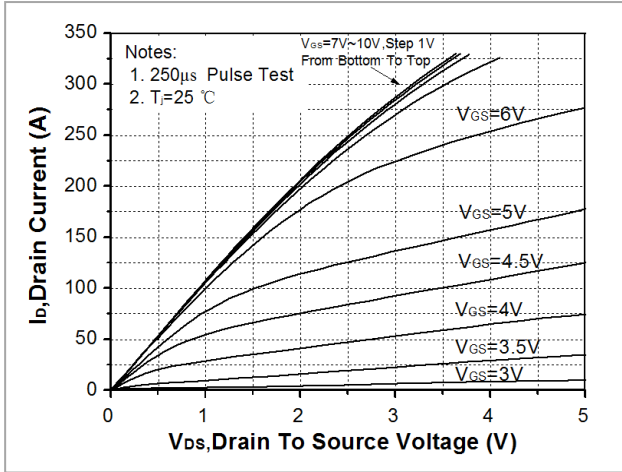

**Fig. 2. Transfer Characteristics**

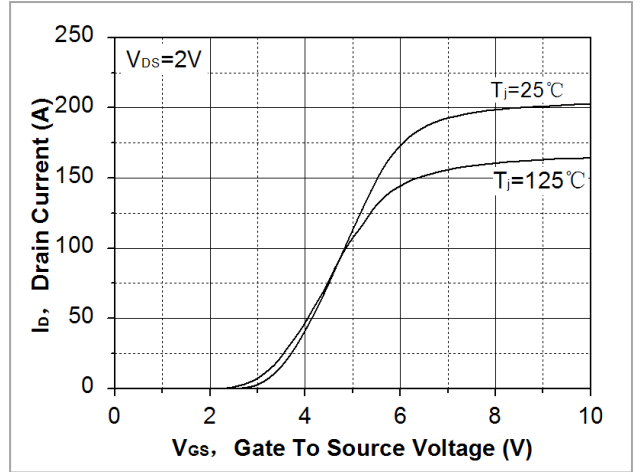

**Fig. 3. On-resistance variation vs. drain current and gate voltage**

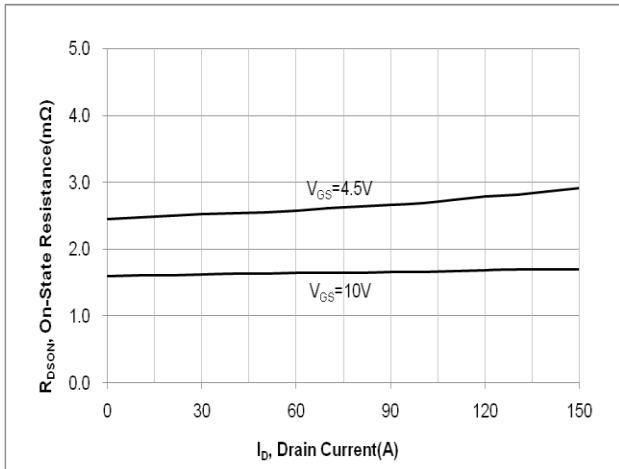

**Fig. 4. On-state current vs. diode forward voltage**

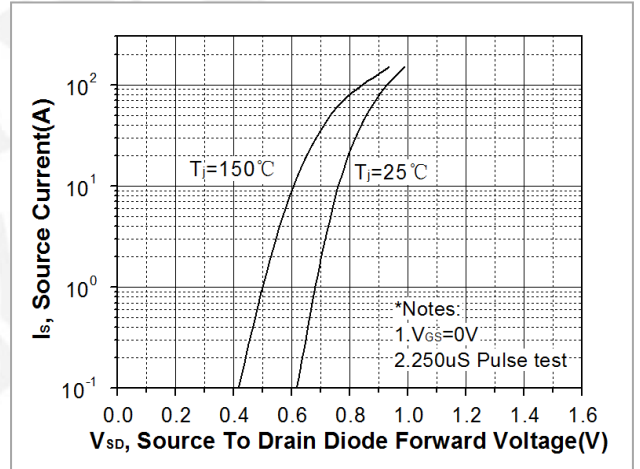

**Fig 5. Breakdown voltage variation vs. junction temperature**

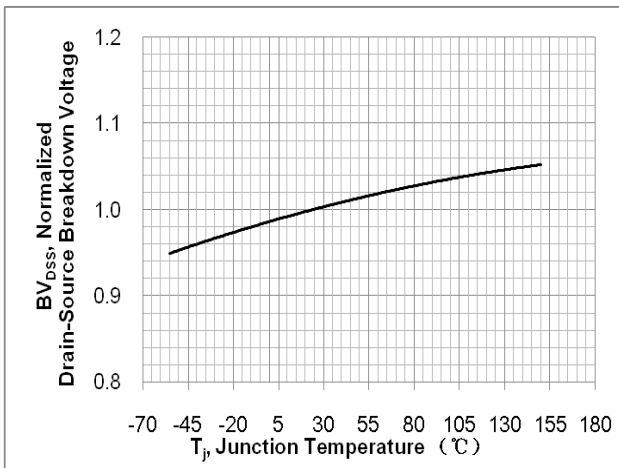

**Fig. 6. On-resistance variation vs. junction temperature**

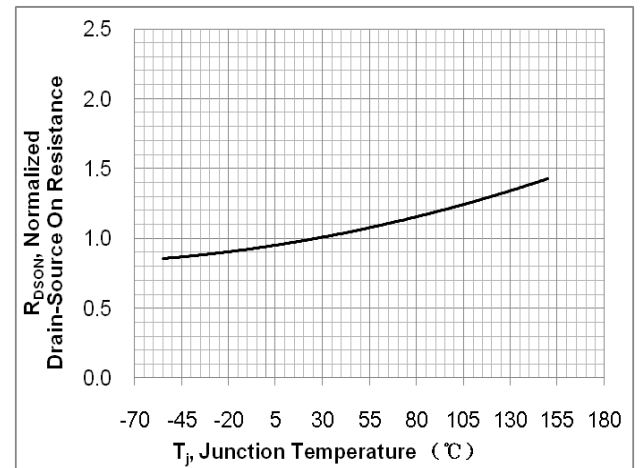

Fig. 7. Gate charge characteristics

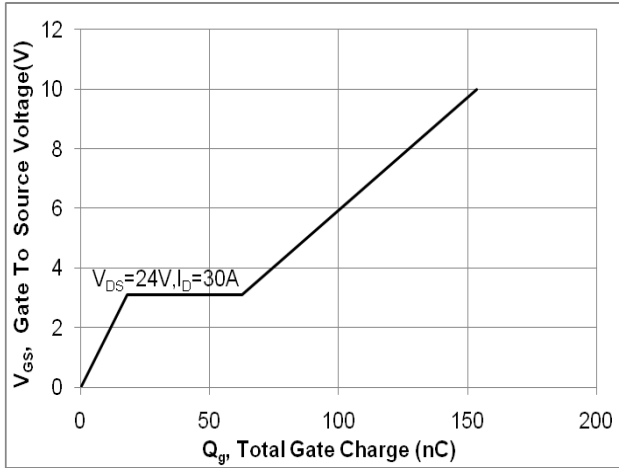

Fig. 8. Capacitance Characteristics

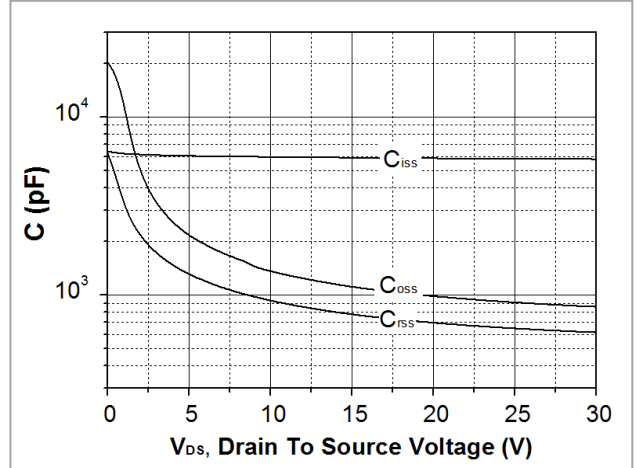

Fig. 9. Maximum safe operating area

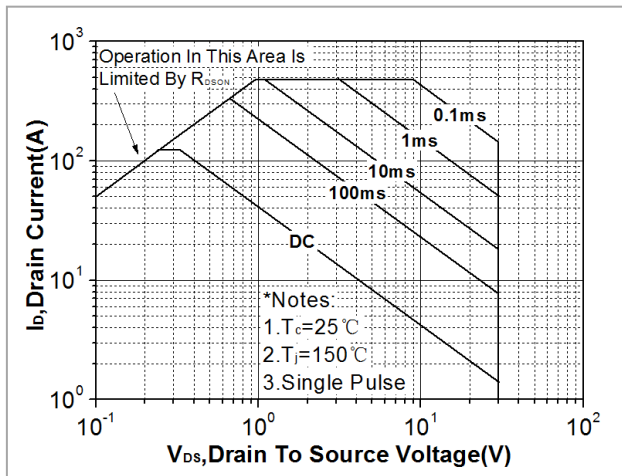

Fig. 10. Maximum drain current vs. case temperature

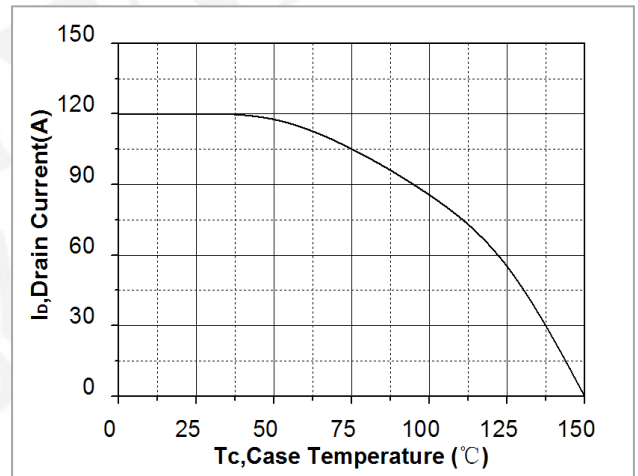
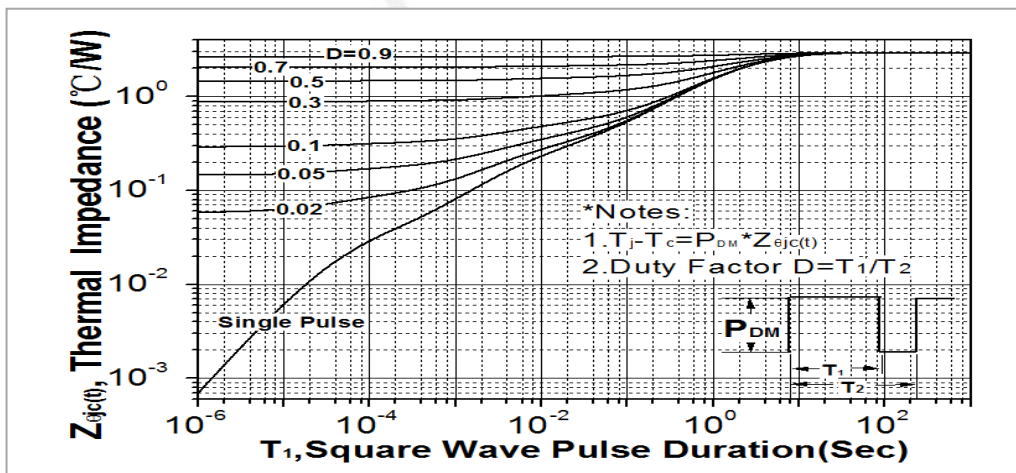
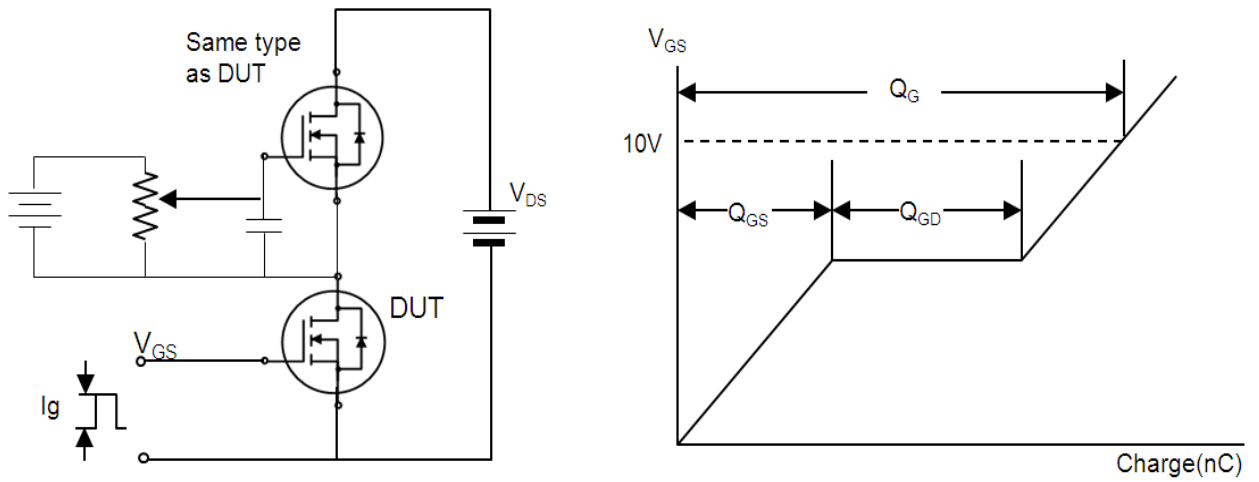

Fig. 11. Transient thermal response curve



**Fig. 12. Gate charge test circuit & waveform**



**Fig. 13. Switching time test circuit & waveform**

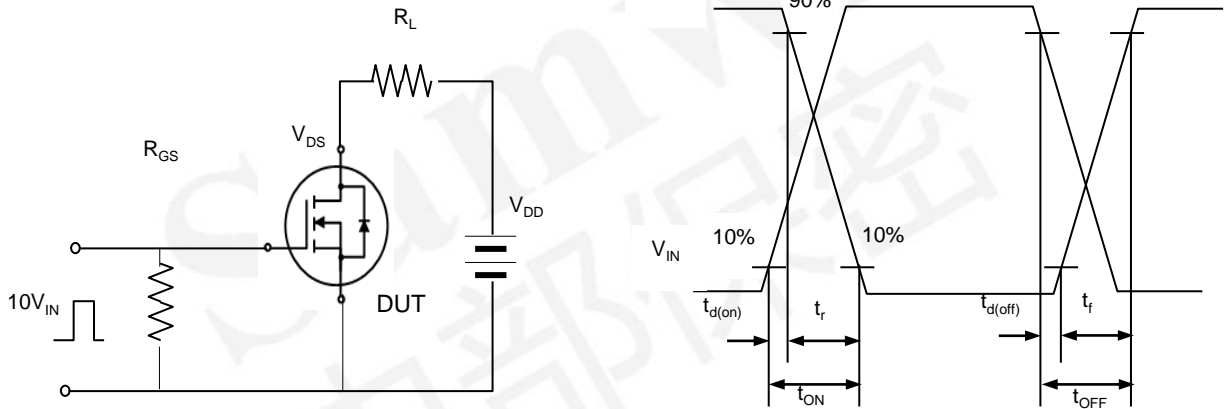

**Fig. 14. Unclamped Inductive switching test circuit & waveform**

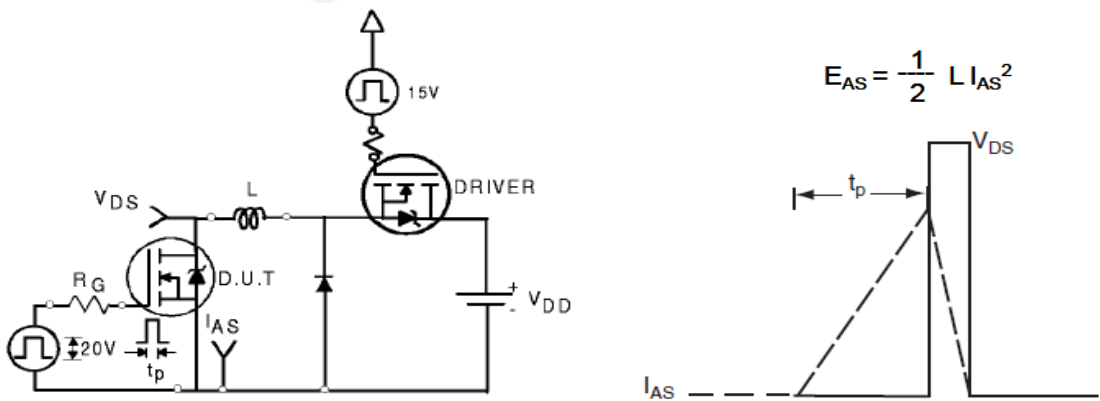
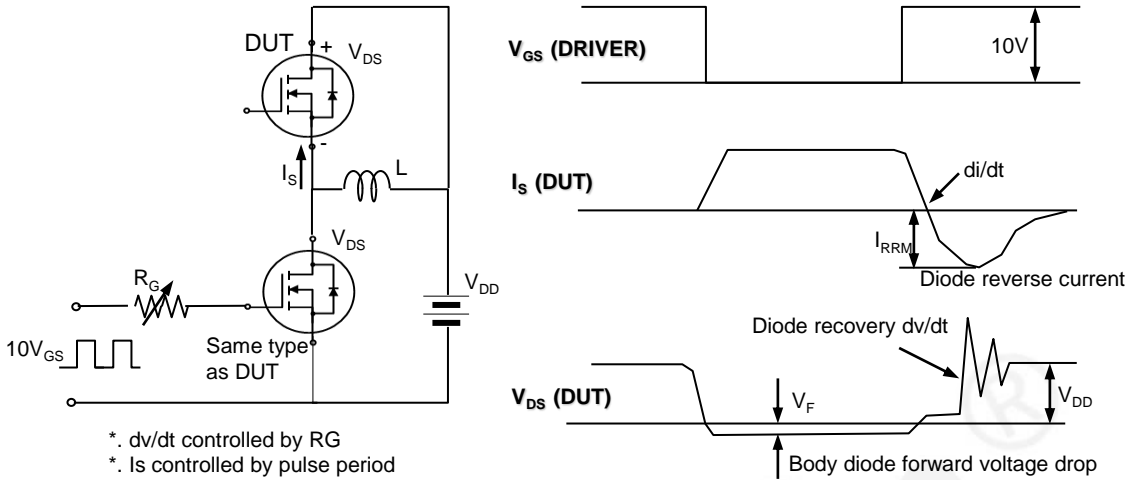



Fig. 15. Peak diode recovery dv/dt test circuit & waveform



### DISCLAIMER

- \* All the data & curve in this document was tested in SEMIPOWER TESTING & APPLICATION CENTER.
- \* This product has passed the PCT,TC,HTRB,HTGB,HAST,PC and Solderdunk reliability testing.
- \* Qualification standards can also be found on the Web site (<http://www.semipower.com.cn>) 
- \* Suggestions for improvement are appreciated, Please send your suggestions to [samwin@samwinsemi.com](mailto:samwin@samwinsemi.com)

## X-ON Electronics

Largest Supplier of Electrical and Electronic Components

*Click to view similar products for [MOSFET](#) category:*

*Click to view products by [Sam&wing](#) manufacturer:*

Other Similar products are found below :

[614233C](#) [648584F](#) [MCH3443-TL-E](#) [MCH6422-TL-E](#) [NTNS3A92PZT5G](#) [IRFD120](#) [IRFF430](#) [JANTX2N5237](#) [2N7000](#) [AOD464](#)  
[2SK2267\(Q\)](#) [2SK2545\(Q,T\)](#) [405094E](#) [423220D](#) [MIC4420CM-TR](#) [VN1206L](#) [614234A](#) [715780A](#) [SSM6J414TU,LF\(T](#) [751625C](#)  
[IPS70R2K0CEAKMA1](#) [BSF024N03LT3 G](#) [PSMN4R2-30MLD](#) [TK31J60W5,S1VQ\(O](#) [2SK2614\(TE16L1,Q\)](#) [DMN1017UCP3-7](#)  
[EFC2J004NUZTDG](#) [FCAB21350L1](#) [P85W28HP2F-7071](#) [DMN1053UCP4-7](#) [NTE2384](#) [NTE2969](#) [NTE6400A](#) [DMC2700UDMQ-7](#)  
[DMN2080UCB4-7](#) [DMN61D9UWQ-13](#) [US6M2GTR](#) [DMN31D5UDJ-7](#) [SSM6P54TU,LF](#) [DMP22D4UFO-7B](#) [IPS60R3K4CEAKMA1](#)  
[DMN1006UCA6-7](#) [DMN16M9UCA6-7](#) [STF5N65M6](#) [IRF40H233XTMA1](#) [IPSA70R950CEAKMA1](#) [IPSA70R2K0CEAKMA1](#) [STU5N65M6](#)  
[C3M0021120D](#) [DMN6022SSD-13](#)