

### N-channel Enhanced mode TO-220/TO-263 MOSFET

#### Features

- High ruggedness
- Low  $R_{DS(ON)}$  (Typ 4.5m $\Omega$ )@ $V_{GS}=10V$
- Low Gate Charge (Typ 182nC)
- Improved dv/dt Capability
- 100% Avalanche Tested
- Application: Synchronous Rectification, Li Battery Protect Board, Inverter

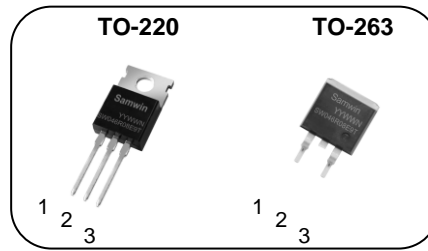

1. Gate 2.Drain 3.Source

$BV_{DSS}$  : 80V  
 $I_D$  : 160A  
 $R_{DS(ON)}$  : 4.5m $\Omega$

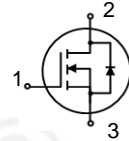

#### General Description

This power MOSFET is produced with advanced technology of SAMWIN. This technology enable the power MOSFET to have better characteristics, including fast switching time, low on resistance, low gate charge and especially excellent avalanche characteristics.



#### Order Codes

Item	Sales Type	Marking	Package	Packaging
1	SW P 046R08E9T	SW046R08E9T	TO-220	TUBE
2	SW B 046R08E9T	SW046R08E9T	TO-263	TUBE

#### Absolute maximum ratings

Symbol	Parameter	Value		Unit
		TO-220	TO-263	
$V_{DSS}$	Drain to source voltage	80		V
$I_D$	Continuous drain current (@ $T_C=25^\circ C$ )	160*		A
	Continuous drain current (@ $T_C=100^\circ C$ )	106*		A
$I_{DM}$	Drain current pulsed (note 1)	640		A
$V_{GS}$	Gate to source voltage	$\pm 20$		V
$E_{AS}$	Single pulsed avalanche energy (note 2)	361		mJ
$E_{AR}$	Repetitive avalanche energy (note 1)	30		mJ
dv/dt	Peak diode recovery dv/dt (note 3)	5		V/ns
$P_D$	Total power dissipation (@ $T_C=25^\circ C$ )	245		W
	Derating factor above 25 $^\circ C$	2.0		W/ $^\circ C$
$T_{STG}, T_J$	Operating junction temperature & storage temperature	-55 ~ + 150		$^\circ C$
$T_L$	Maximum lead temperature for soldering purpose, 1/8 from case for 5 seconds.	300		$^\circ C$

\*. Drain current is limited by junction temperature.

#### Thermal characteristics

Symbol	Parameter	Value		Unit
		TO-220	TO-263	
$R_{thjc}$	Thermal resistance, Junction to case	0.51		$^\circ C/W$
$R_{thja}$	Thermal resistance, Junction to ambient	47.6		$^\circ C/W$

## Electrical characteristic ( $T_J = 25^\circ\text{C}$ unless otherwise specified )

Symbol	Parameter	Test conditions	Min.	Typ.	Max.	Unit
<b>Off characteristics</b>						
$BV_{DSS}$	Drain to source breakdown voltage	$V_{GS}=0V, I_D=250\mu A$	80			V
$\Delta BV_{DSS} / \Delta T_J$	Breakdown voltage temperature coefficient	$I_D=250\mu A$ , referenced to $25^\circ\text{C}$		0.08		$V/^\circ\text{C}$
$I_{DSS}$	Drain to source leakage current	$V_{DS}=80V, V_{GS}=0V$			1	$\mu A$
		$V_{DS}=64V, T_J=125^\circ\text{C}$			50	$\mu A$
$I_{GSS}$	Gate to source leakage current, forward	$V_{GS}=20V, V_{DS}=0V$			100	nA
	Gate to source leakage current, reverse	$V_{GS}=-20V, V_{DS}=0V$			-100	nA
<b>On characteristics</b>						
$V_{GS(TH)}$	Gate threshold voltage	$V_{DS}=V_{GS}, I_D=250\mu A$	2		4	V
$R_{DS(ON)}$	Drain to source on state resistance	$V_{GS}=10V, I_D=30A, T_J=25^\circ\text{C}$		4.5	5.9	$m\Omega$
		$V_{GS}=10V, I_D=30A, T_J=125^\circ\text{C}$		7.8		$m\Omega$
$G_{fs}$	Forward transconductance	$V_{DS}=5V, I_D=30A$		68		S
<b>Dynamic characteristics</b>						
$C_{iss}$	Input capacitance	$V_{GS}=0V, V_{DS}=40V, f=1\text{MHz}$		8570		pF
$C_{oss}$	Output capacitance			625		
$C_{rss}$	Reverse transfer capacitance			400		
$t_{d(on)}$	Turn on delay time	$V_{DS}=40V, I_D=30A, R_G=4.7\Omega, V_{GS}=10V$ (note 4,5)		35		ns
$t_r$	Rising time			75		
$t_{d(off)}$	Turn off delay time			171		
$t_f$	Fall time			68		
$Q_g$	Total gate charge	$V_{DS}=64V, V_{GS}=10V, I_D=30A, I_G=5\text{mA}$ (note 4,5)		182		nC
$Q_{gs}$	Gate-source charge			39		
$Q_{gd}$	Gate-drain charge			63		
$R_g$	Gate resistance		$V_{DS}=0V$ , Scan F mode		3.4	

## Source to drain diode ratings characteristics

Symbol	Parameter	Test conditions	Min.	Typ.	Max.	Unit
$I_S$	Continuous source current	Integral reverse p-n Junction diode in the MOSFET			160	A
$I_{SM}$	Pulsed source current				640	A
$V_{SD}$	Diode forward voltage drop.	$I_S=30A, V_{GS}=0V$			1.4	V
$t_{rr}$	Reverse recovery time	$I_S=30A, V_{GS}=0V, di/dt=100A/\mu s$		49		ns
$Q_{rr}$	Reverse recovery charge				90	nC

### ※. Notes

1. Repeattive rating : pulse width limited by junction temperature.
2.  $L=0.5\text{mH}, I_{AS}=38A, V_{DD}=50V, R_G=25\Omega$ , Starting  $T_J=25^\circ\text{C}$
3.  $I_{SD} \leq 30A, di/dt = 100A/\mu s, V_{DD} \leq BV_{DSS}$ , Starting  $T_J=25^\circ\text{C}$
4. Pulse Test : Pulse Width  $\leq 300\mu s$ , duty cycle  $\leq 2\%$ .
5. Essentially independent of operating temperature.

**Fig. 1. On-state characteristics**

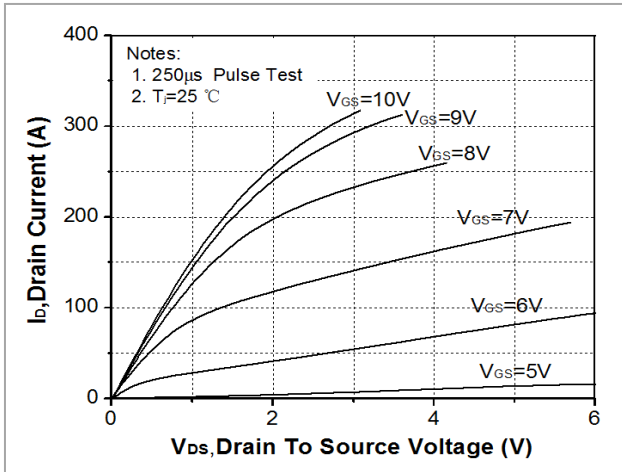

**Fig. 2. Transfer Characteristics**

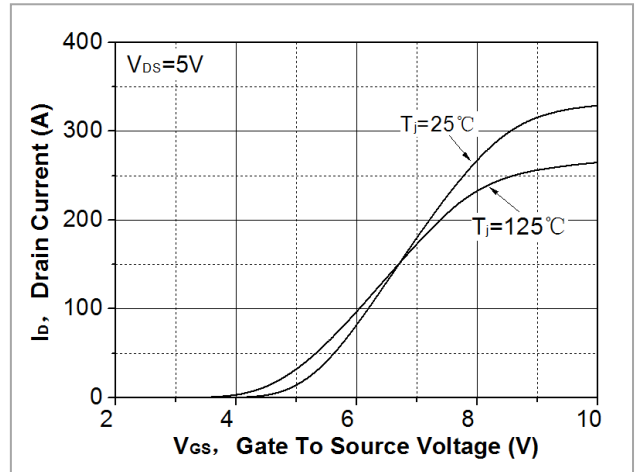

**Fig. 3. On-resistance variation vs. drain current and gate voltage**

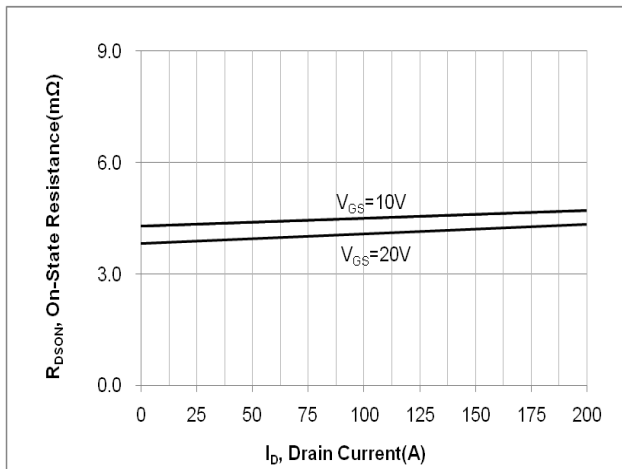

**Fig. 4. On-state current vs. diode forward voltage**

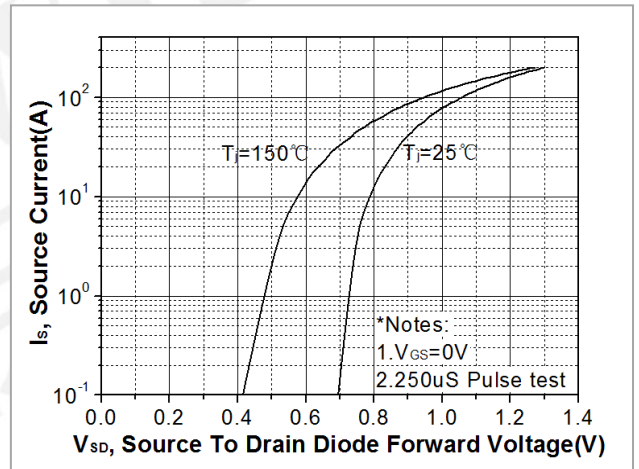

**Fig 5. Breakdown voltage variation vs. junction temperature**

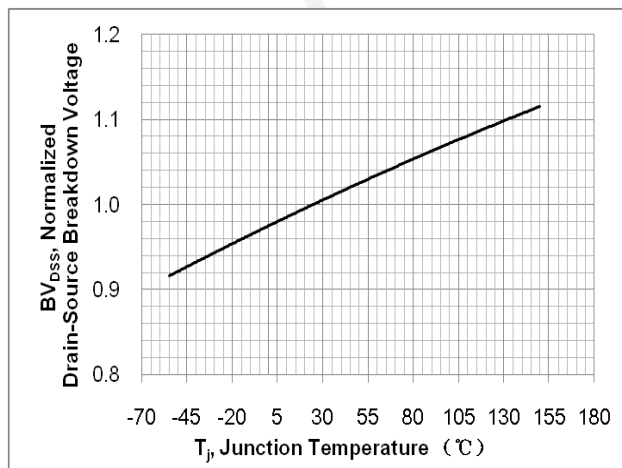

**Fig. 6. On-resistance variation vs. junction temperature**

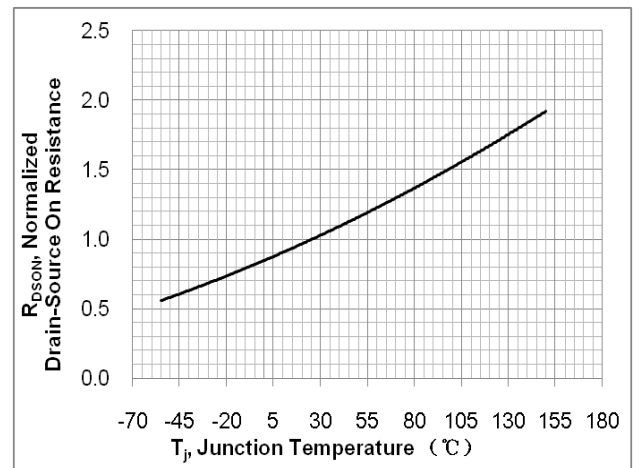

Fig. 7. Gate charge characteristics

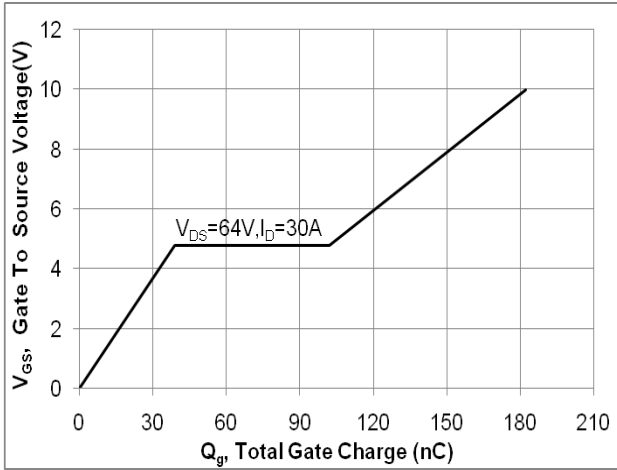

Fig. 8. Capacitance Characteristics

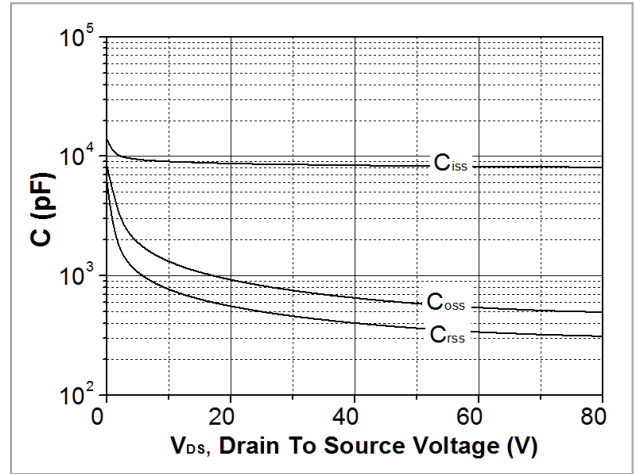

Fig. 9. Maximum safe operating area (TO-220 & TO-263)

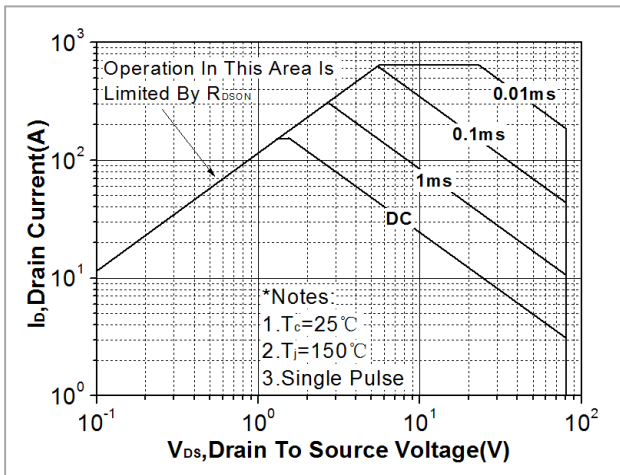

Fig. 10. Maximum drain current vs. case temperature (TO-220 & TO-263)

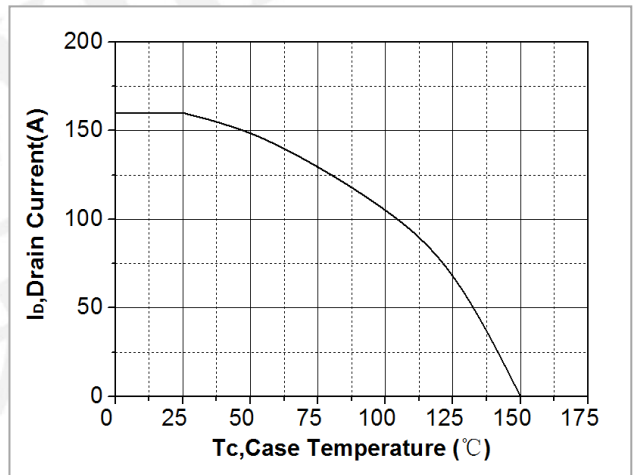
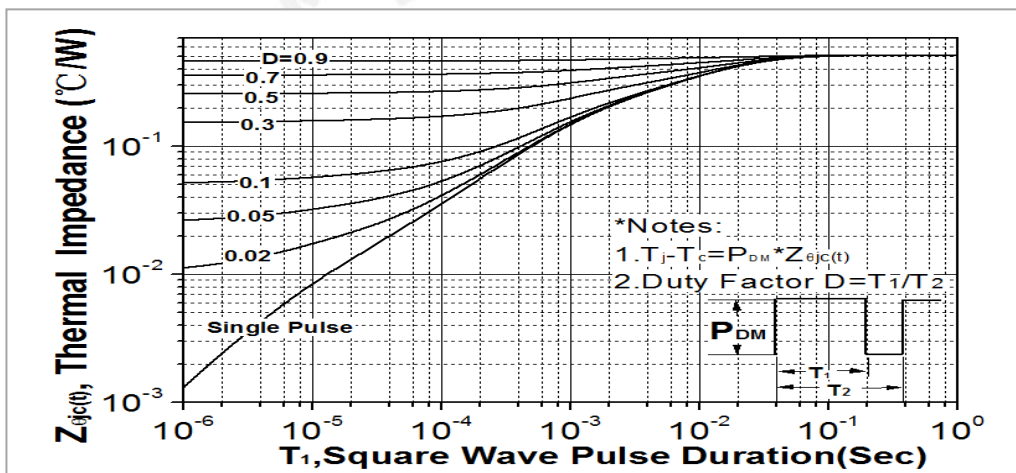
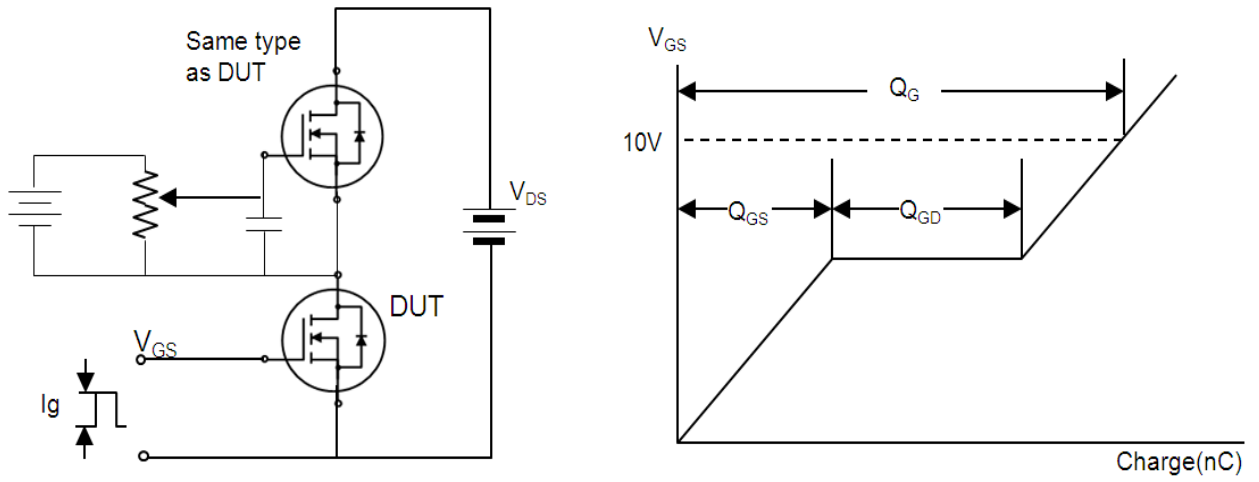

Fig. 11. Transient thermal response curve (TO-220 & TO-263)



**Fig. 12. Gate charge test circuit & waveform**



**Fig. 13. Switching time test circuit & waveform**



**Fig. 14. Unclamped Inductive switching test circuit & waveform**



Fig. 15. Peak diode recovery dv/dt test circuit & waveform

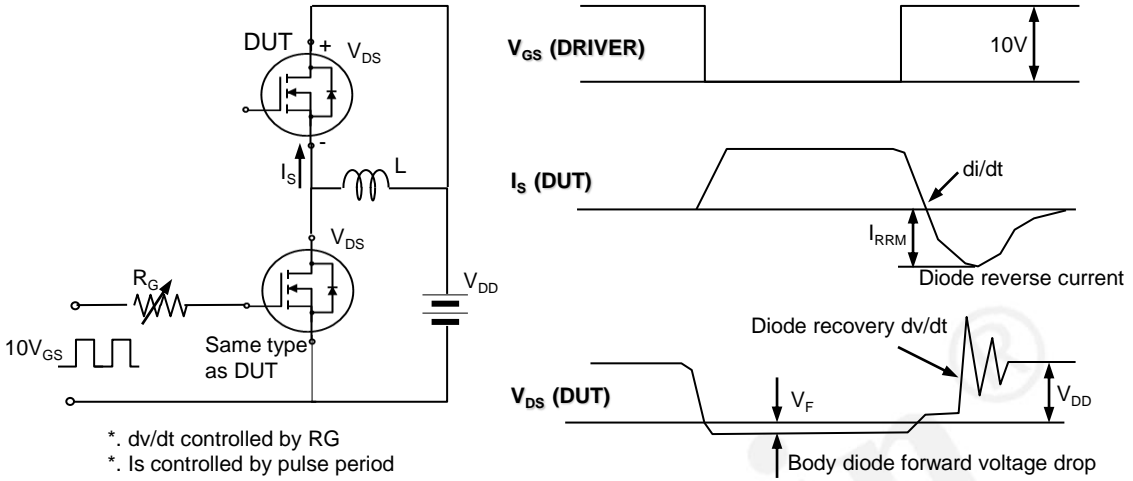

### DISCLAIMER

\* All the data & curve in this document was tested in SEMIPOWER TESTING & APPLICATION CENTER.

\* This product has passed the PCT,TC,HTRB,HTGB,HAST,PC and Solderdunk reliability testing.

\* Qualification standards can also be found on the Web site (<http://www.semipower.com.cn>) 

\* Suggestions for improvement are appreciated, Please send your suggestions to [samwin@samwinsemi.com](mailto:samwin@samwinsemi.com)

## X-ON Electronics

Largest Supplier of Electrical and Electronic Components

*Click to view similar products for [MOSFET](#) category:*

*Click to view products by [Sam&wing](#) manufacturer:*

Other Similar products are found below :

[IRFD120](#) [JANTX2N5237](#) [2SK2267\(Q\)](#) [BUK455-60A/B](#) [TK100A10N1,S4X\(S](#) [MIC4420CM-TR](#) [VN1206L](#) [NDP4060](#) [SI4482DY](#)  
[IRS2092STRPBF-EL](#) [IPS70R2K0CEAKMA1](#) [TK31J60W5,S1VQ\(O](#) [TK31J60W,S1VQ\(O](#) [TK16J60W,S1VQ\(O](#) [2SK2614\(TE16L1,Q\)](#)  
[DMN1017UCP3-7](#) [EFC2J004NUZTDG](#) [P85W28HP2F-7071](#) [DMN1053UCP4-7](#) [NTE2384](#) [DMC2700UDMQ-7](#) [DMN2080UCB4-7](#)  
[DMN61D9UWQ-13](#) [US6M2GTR](#) [DMN31D5UDJ-7](#) [DMP22D4UFO-7B](#) [IPS60R3K4CEAKMA1](#) [DMN1006UCA6-7](#) [DMN16M9UCA6-7](#)  
[STF5N65M6](#) [IRF40H233XTMA1](#) [STU5N65M6](#) [DMN6022SSD-13](#) [DMN13M9UCA6-7](#) [DMTH10H4M6SPS-13](#) [IPS60R360PFD7SAKMA1](#)  
[DMN2990UFB-7B](#) [SSM3K35CT,L3F](#) [IPLK60R1K0PFD7ATMA1](#) [2N7002W-G](#) [MCAC30N06Y-TP](#) [IPWS65R035CFD7AXKSA1](#)  
[MCQ7328-TP](#) [SSM3J143TU,LXHF](#) [DMN12M3UCA6-7](#) [PJMF280N65E1\\_T0\\_00201](#) [PJMF380N65E1\\_T0\\_00201](#)  
[PJMF280N60E1\\_T0\\_00201](#) [PJMF600N65E1\\_T0\\_00201](#) [PJMF900N65E1\\_T0\\_00201](#)