

2SA1673

Silicon PNP Epitaxial Planar Transistor (Complement to type 2SC4388)

Application : Audio and General Purpose

Absolute maximum ratings (Ta=25°C)

Symbol	Rated	Unit
V _{CB0}	-180	V
V _{CE0}	-180	V
V _{EB0}	-6	V
I _C	-15	A
I _B	-4	A
P _C	85(T _C =25°C)	W
T _J	150	°C
T _{stg}	-55 to +150	°C

Electrical Characteristics (Ta=25°C)

Symbol	Conditions	Rated	Unit
I _{CB0}	V _{CB} =-180V	-10max	μA
I _{EB0}	V _{EB} =-6V	-10max	μA
V _{(BR)CEO}	I _C =-50mA	-180min	V
h _{FE}	V _{CE} =-4V, I _C =-3A	50min*	
V _{CE(sat)}	I _C =-5A, I _B =-0.5A	-2.0max	V
f _T	V _{CE} =-12V, I _E =0.5A	20typ	MHz
C _{OB}	V _{CB} =-10V, f=1MHz	500typ	pF

*h_{FE} Rank \bar{O} (50to100), P(70to140), Y(90to180)

External Dimensions FM100(TO3PF)

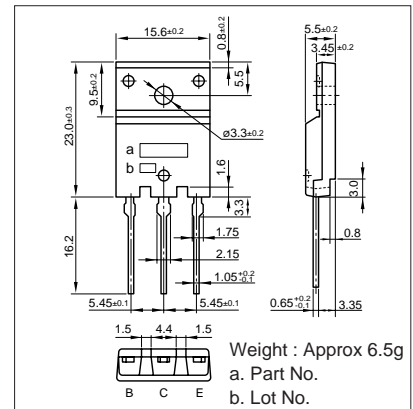

Typical Switching Characteristics (Common Emitter)

V _{CC} (V)	R _L (Ω)	I _C (A)	V _{BB1} (V)	V _{BB2} (V)	I _{B1} (A)	I _{B2} (A)	t _{on} (μs)	t _{sig} (μs)	t _f (μs)
-40	4	-10	-10	5	-1	1	0.6typ	0.9typ	0.2typ

I_C-V_{CE} Characteristics (Typical)

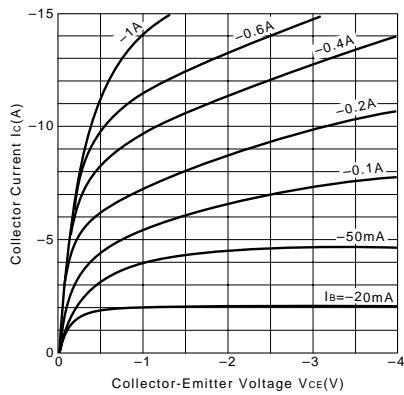

V_{CE(sat)}-I_B Characteristics (Typical)

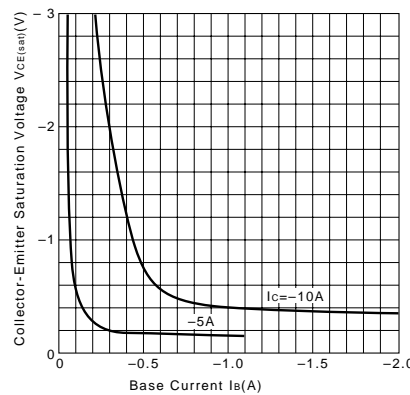

I_C-V_{BE} Temperature Characteristics (Typical)

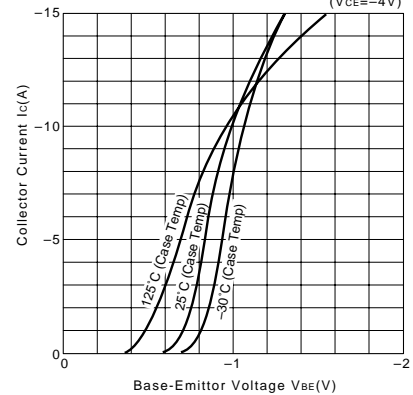

h_{FE}-I_C Characteristics (Typical)

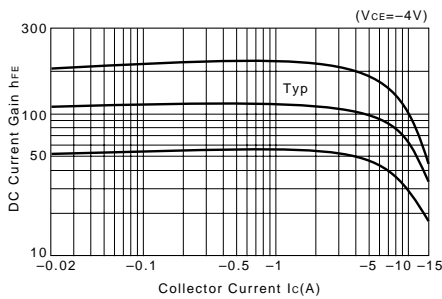

h_{FE}-I_C Temperature Characteristics (Typical)

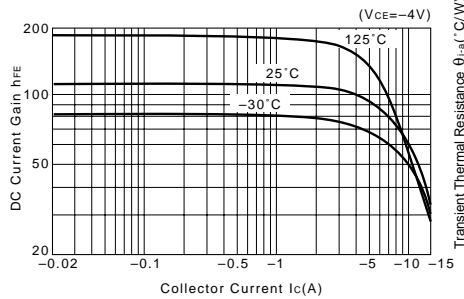

θ_{ja}-t Characteristics

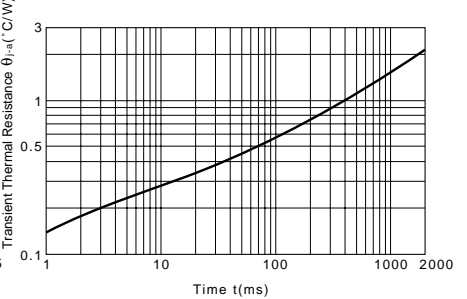

f_T-I_E Characteristics (Typical)

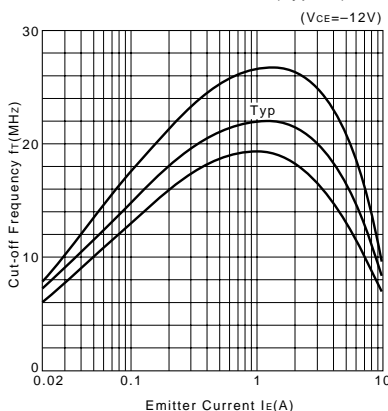

Safe Operating Area (Single Pulse)

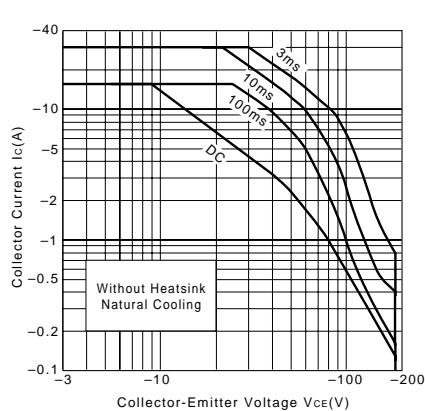

P_C-T_a Derating

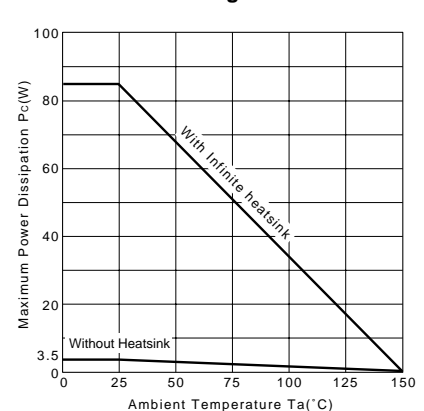

X-ON Electronics

Largest Supplier of Electrical and Electronic Components

Click to view similar products for [Sanken](#) manufacturer:

Other Similar products are found below :

[2SA1668](#) [2SA1673](#) [2SB1257](#) [2SB1560](#) [2SC4466](#) [2SC4467](#) [2SC5100](#) [2SD2560](#) [C300H](#) [CWB030-12](#) [CWB030-15](#) [CWB050-15](#) [FMM-G2CS](#) [LC5523F](#) [LC5546LF](#) [LC5547LF](#) [SED80N2-16.0](#) [SED80N3-16.0](#) [SEE55N2-19.0](#) [SEE75N2-19.0](#) [SI-8033S-LF1101](#) [SIM6812M](#)
[SIM6813M](#) [SLA4031](#) [SWC100-24](#) [SWF050P-24](#) [SWF100P-48](#) [SWF150P-24](#) [SWF240P-24](#) [TMA36S-L](#) [TMB206S-L](#)