

2SA1695

Silicon PNP Epitaxial Planar Transistor (Complement to type 2SC4468)

Application : Audio and General Purpose

■ Absolute maximum ratings (Ta=25°C)

Symbol	Ratings	Unit
V _{CB0}	-140	V
V _{CEO}	-140	V
V _{EB0}	-6	V
I _C	-10	A
I _B	-4	A
P _C	100(T _C =25°C)	W
T _J	150	°C
T _{stg}	-55 to +150	°C

■ Electrical Characteristics (Ta=25°C)

Symbol	Conditions	Ratings	Unit
I _{CB0}	V _{CB} =-140V	-10max	μA
I _{EB0}	V _{EB} =-6V	-10max	μA
V _{(BR)CEO}	I _C =-50mA	-140min	V
h _{FE}	V _{CE} =-4V, I _C =-3A	50min*	
V _{CE(sat)}	I _C =-5A, I _B =-0.5A	-0.5max	V
f _T	V _{CE} =-12V, I _E =0.5A	20typ	MHz
C _{OB}	V _{CB} =-10V, f=1MHz	400typ	pF

*h_{FE} Rank ○(50 to 100), P(70 to 140), Y(90 to 180)

■ Typical Switching Characteristics (Common Emitter)

V _{CC} (V)	R _L (Ω)	I _C (A)	V _{BB1} (V)	V _{BB2} (V)	I _{B1} (A)	I _{B2} (A)	t _{on} (μs)	t _{stg} (μs)	t _f (μs)
-60	12	-5	-10	5	-0.5	0.5	0.17typ	1.86typ	0.27typ

External Dimensions MT-100(TO3P)

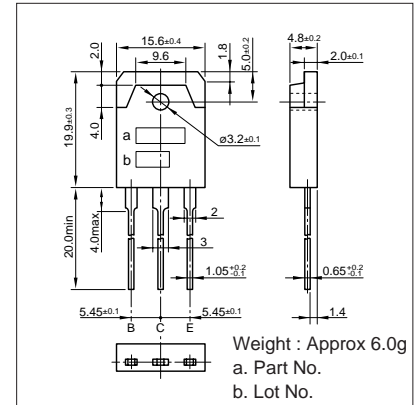

I_C-V_{CE} Characteristics (Typical)

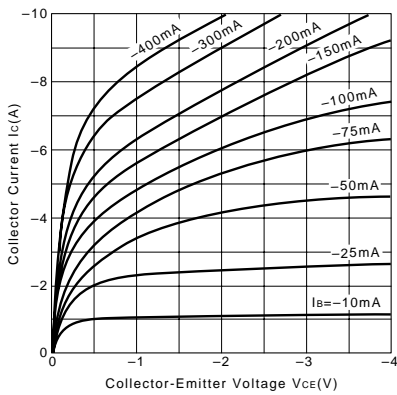

V_{CE(sat)}-I_B Characteristics (Typical)

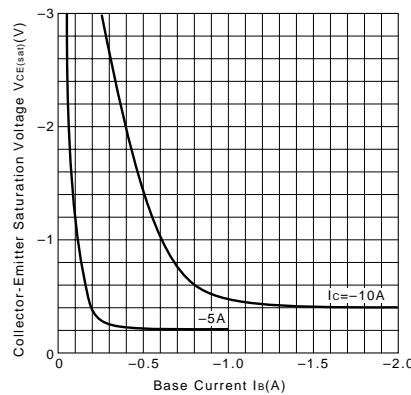

I_C-V_{BE} Temperature Characteristics (Typical)

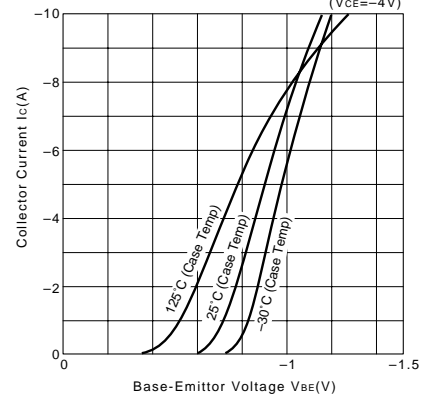

h_{FE}-I_C Characteristics (Typical)

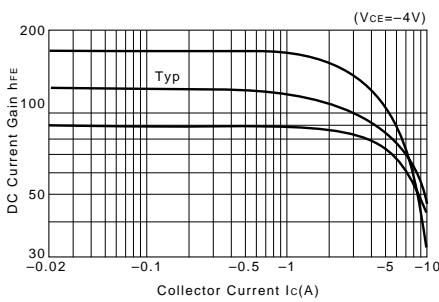

h_{FE}-I_C Temperature Characteristics (Typical)

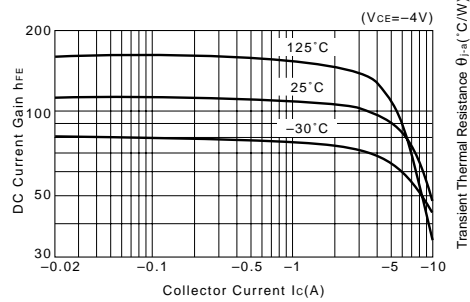

θ_{j-a}-t Characteristics

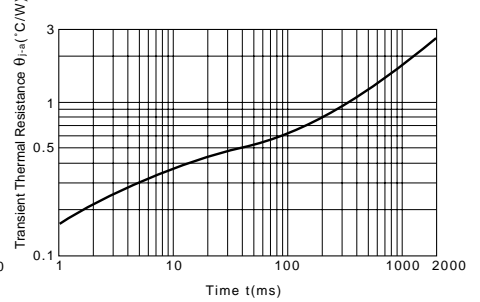

f_T-I_E Characteristics (Typical)

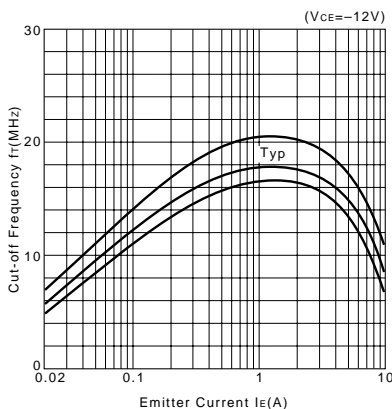

Safe Operating Area (Single Pulse)

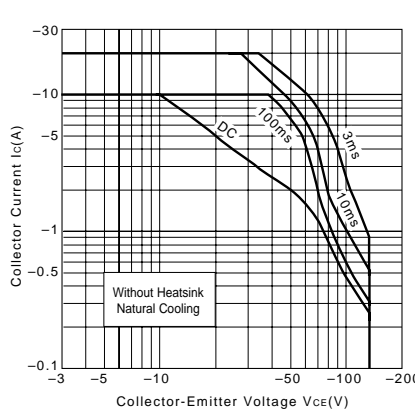

P_C-T_a Derating

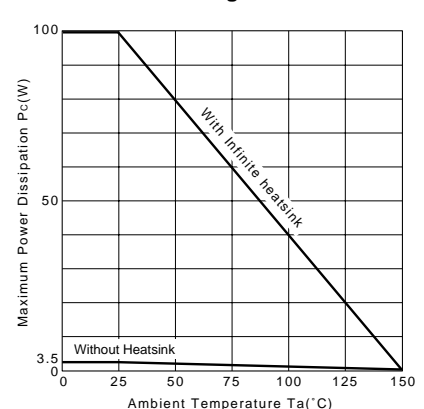

X-ON Electronics

Largest Supplier of Electrical and Electronic Components

Click to view similar products for [Sanken](#) manufacturer:

Other Similar products are found below :

[2SA1668](#) [2SA1673](#) [2SA1695](#) [2SB1257](#) [2SB1560](#) [2SC4466](#) [2SC4467](#) [2SC5100](#) [2SD2560](#) [C300H](#) [CWB030-12](#) [CWB030-15](#) [CWB050-15](#)
[FMM-G2CS](#) [LC5523F](#) [LC5546LF](#) [LC5547LF](#) [SED80N2-16.0](#) [SED80N3-16.0](#) [SEE55N2-19.0](#) [SEE75N2-19.0](#) [SI-8033S-LF1101](#)
[SIM6812M](#) [SLA4031](#) [STR3A451](#) [STR3A451D](#) [STR3A453](#) [STR3A453D](#) [SWC100-24](#) [SWF050P-24](#) [SWF150P-24](#) [SWF240P-24](#) [TMA36S-](#)
[L](#) [TMB206S-L](#)