

2SC4467

Silicon NPN Triple Diffused Planar Transistor (Complement to type 2SA1694)

Application : Audio and General Purpose

Absolute maximum ratings (Ta=25°C)

Symbol	Ratings	Unit
V _{CB0}	160	V
V _{CE0}	120	V
V _{EB0}	6	V
I _C	8	A
I _B	3	A
P _C	80(T _C =25°C)	W
T _j	150	°C
T _{stg}	-55 to +150	°C

Electrical Characteristics (Ta=25°C)

Symbol	Conditions	Ratings	Unit
I _{CB0}	V _{CB} =160V	10max	μA
I _{EB0}	V _{EB} =6V	10max	μA
V(BR) _{CEO}	I _C =50mA	120min	V
h _{FE}	V _{CE} =4V, I _C =3A	50min*	
V _{CE(sat)}	I _C =3A, I _B =0.3A	1.5max	V
f _r	V _{CE} =12V, I _E =-0.5A	20typ	MHz
COB	V _{CB} =10V, f=1MHz	200typ	pF

*h_{FE} Rank \bar{O} (50to100), P(70to140), Y(90to180)

Typical Switching Characteristics (Common Emitter)

V _{CC} (V)	R _L (Ω)	I _C (A)	V _{BB1} (V)	V _{BB2} (V)	I _{B1} (A)	I _{B2} (A)	t _{on} (μs)	t _{stg} (μs)	t _f (μs)
40	10	4	10	-5	0.4	-0.4	0.13typ	3.50typ	0.32typ

External Dimensions MT-100(TO3P)

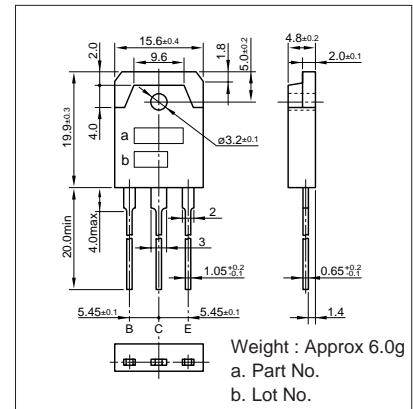

I_C-V_{CE} Characteristics (Typical)

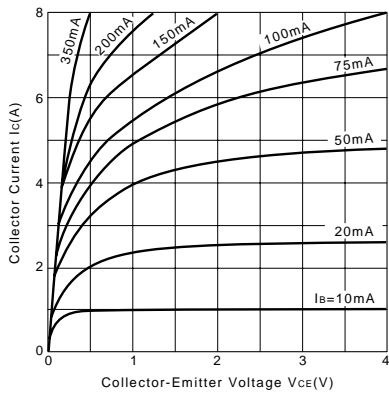

V_{CE(sat)}-I_B Characteristics (Typical)

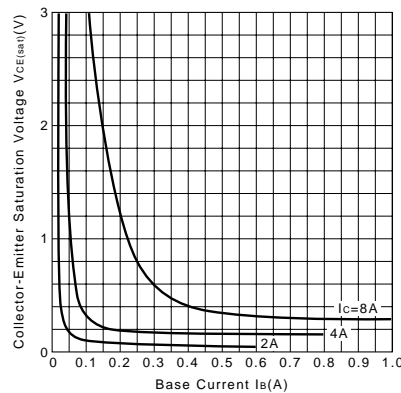

I_C-V_{BE} Temperature Characteristics (Typical)

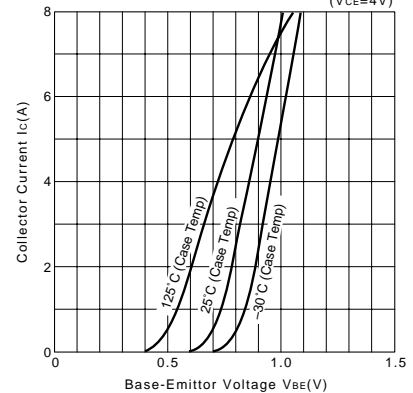

h_{FE}-I_C Characteristics (Typical)

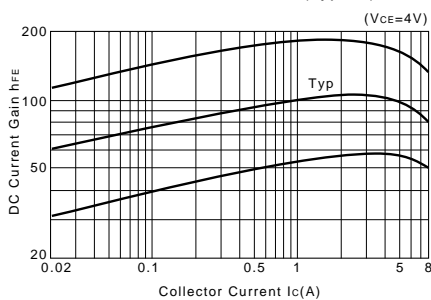

h_{FE}-I_C Temperature Characteristics (Typical)

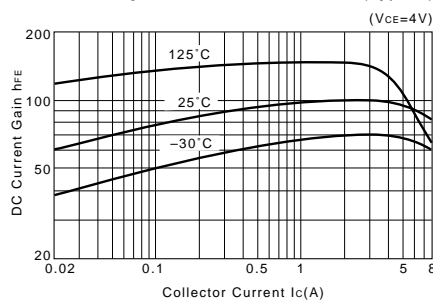

θ_{j-a}-t Characteristics

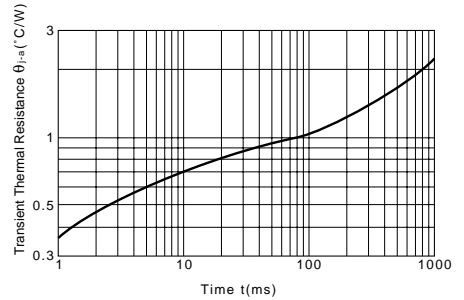

f_r-I_E Characteristics (Typical)

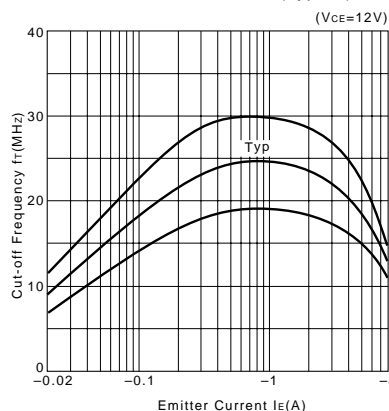

Safe Operating Area (Single Pulse)

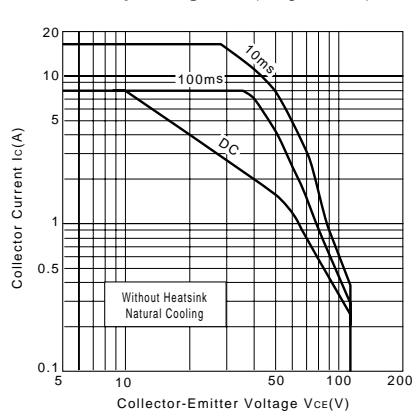

P_C-T_a Derating

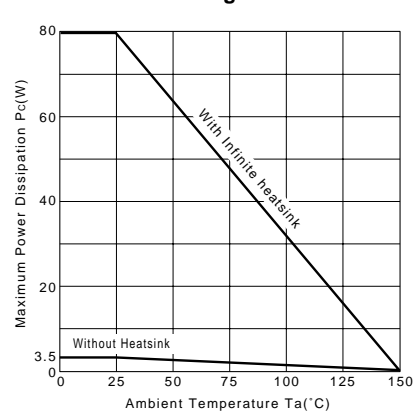

X-ON Electronics

Largest Supplier of Electrical and Electronic Components

Click to view similar products for [Bipolar Transistors - BJT category](#):

Click to view products by [Sanken manufacturer](#):

Other Similar products are found below :

[BC559C](#) [MCH4017-TL-H](#) [MMBT-2369-TR](#) [BC546/116](#) [NJVMJD148T4G](#) [NTE16](#) [NTE195A](#) [IMX9T110](#) [2N4401-A](#) [2N6728](#) [2SA1419T-TD-H](#) [2SB1204S-TL-E](#) [2SC5488A-TL-H](#) [FMC5AT148](#) [2N2369ADCSM](#) [2N2907A](#) [2N3904-NS](#) [2N5769](#) [2SC4618TLN](#) [CPH6501-TL-E](#) [BC856BW-13-F](#) [US6T6TR](#) [BAX18/A52R](#) [BC556/112](#) [IMZ2AT108](#) [MMST8098T146](#) [MCH6102-TL-E](#) [BC846B-13-F](#) [2N3879](#) [30A02MH-TL-E](#) [NTE13](#) [NTE282](#) [NTE323](#) [NTE350](#) [NTE81](#) [JANTX2N2920L](#) [JANSR2N2907AUB](#) [CMLT3946EG TR](#) [SNSS40600CF8T1G](#) [CMLT3906EG TR](#) [GRP-DATA-JANS2N2907AUB](#) [GRP-DATA-JANS2N2222AUA](#) [MMDT3946FL3-7](#) [2N4240](#) [JANS2N3019](#) [MSB30KH-13](#) [2N2221AUB](#) [2SD1815T-TL-E](#) [2N6678](#) [2N2907Ae4](#)