

SOFT RECOVERY DIODE MODULE

DCA200UA65

UL: E76102 (M)

DCA200UA65

(Features & Advantages)

- Achieve a balance between low loss (VF=1.4V [Typ]) and higher soft recovery characteristics due to a local lifetime control using ion irradiation technology. Therefore, prevent occurrence of noise based on high surge voltage generated during reverse recovery operation.
- Reducing "Thermal Resistance" 40% due to adopting high heat radiation material and a new design internal configuration.
- Low loss based on low $I_{RRM} \leq 50\text{mA}$, 50% lower than our existing product. ($T_j=150^\circ\text{C}$)
- High power isolated package.

(特長)

- イオン照射技術を用いた局所ライフタイム制御により、低損失(VF=1.4V [Typ])と高いソフト性を両立。逆回復時に発生するサージ電圧によるノイズを大幅に抑制。
- 高放熱材料の採用と新設計構造で熱抵抗を40%低減(当社比)
- 逆電流 $I_{RRM} \leq 50\text{mA}$ の低損失 従来比1/2以下(当社比 $T_j=150^\circ\text{C}$)
- 大電力絶縁型パッケージ

(Applications)

Plasma cutting machine, Welding machine, Power supplies, PV inverter (Booster chopper circuit)

(用途)

プラズマ切断機、溶接機、各種電源装置、太陽光インバータ(昇圧ブースター部)

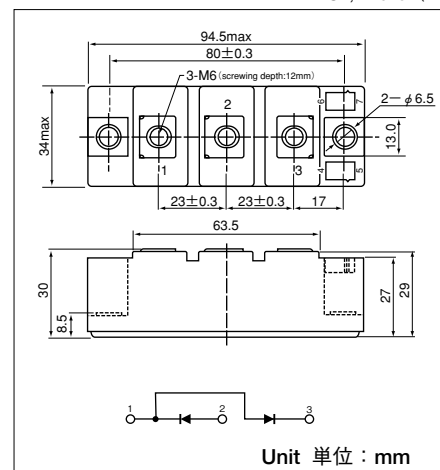

Maximum Ratings 最大定格

(Unless otherwise specified $T_j=25^\circ\text{C}$ / 特にことわらない限り $T_j=25^\circ\text{C}$)

Symbol 記号	Item 項目	Ratings 定格値		Unit 単位
		DCA200UA65		
V_{RRM}	Repetitive Peak Reverse Voltage 定格ピーク繰返し逆電圧	650		V
$V_{R(DC)}$	Reverse D.C. Voltage 直流逆電圧	600		V

Symbol 記号	Item 項目	Conditions 条件	Ratings 定格値	Unit 単位	
$I_{F(AV)}$	Output Current 定格平均順電流	D.C. $T_c=85^\circ\text{C}$ 直流, ケース温度 85°C	200	A	
I_{FSM}	Surge Forward Current 定格サージ順電流	$\frac{1}{2}$ cycle, 60Hz, Peak value, non-repetitive $\frac{1}{2}$ サイクル正弦波, 60Hz, 波高値, 非繰返し	1350	A	
I^2t	I^2t 電流二乗時間積	Value for one cycle of surge current (60Hz) 1 サイクルサージオン電流に対する値	7500	A^2s	
T_j	Junction Temperature 定格接合部温度		$-40 \sim +150$	$^\circ\text{C}$	
T_{stg}	Storage Temperature 保存温度		$-40 \sim +125$	$^\circ\text{C}$	
V_{ISO}	Isolation Voltage (R.M.S.) 絶縁耐圧 (実効値)	A.C. 1 minute A.C. 1 分間	2500	V	
	Mounting torque 締付トルク	Mounting M6 取付 (M6)	Recommended Value 推奨値 2.5~3.9 (25~40)	4.7 (48)	N·m (kgf·cm)
		Terminal M6 端子 (M6)	Recommended Value 推奨値 2.5~3.9 (25~40)		
	Mass 質量	Typical Value 代表値	200	g	

Electrical Characteristics 電気的特性

(Unless otherwise specified $T_j=25^\circ\text{C}$ / 特にことわらない限り $T_j=25^\circ\text{C}$)

Symbol 記号	Item 項目	Conditions 条件	Ratings 規格値			Unit 単位
			Min.	Typ.	Max.	
I_{RRM}	Repetitive Peak Reverse Current 逆電流	$V_R=V_{RRM}$, $T_j=150^\circ\text{C}$			50	mA
V_{FM}	Forward Voltage Drop 順電圧降下	$I_F=200\text{A}$, Inst. measurement 瞬時測定	1.40	1.70		V
t_{rr}	Reverse recovery time 逆回復時間	$I_F=200\text{A}$, $V_R=300\text{V}$, $-di/dt=400\text{A}/\mu\text{s}$	210	360		ns
i_{rr}	Reverse recovery peak current 逆回復ピーク電流		35	50		A
t_b/t_a	Softness ソフトネス性		1.0			
$V_{T(TO)}$	Threshold Voltage 閾値電圧	$T_j=150^\circ\text{C}$			0.98	V
r_t	Slope Resistance スロープ抵抗	$T_j=150^\circ\text{C}$			3.0	m Ω
$R_{th(j-c)}$	Thermal Resistance 熱抵抗 (接合部-ケース間)	Junction to case, per $\frac{1}{2}$ module $\frac{1}{2}$ モジュール			0.19	$^\circ\text{C}/\text{W}$
$R_{th(c-f)}$	Contact Thermal Resistance 接触熱抵抗 (ケース-ヒートシンク間)	Case to Heat sink, per one module Thermal Conductivity (Silicon grease) = $7 \times 10^{-3} [\text{W}/\text{cm} \cdot ^\circ\text{C}]$ ケース-ヒートシンク間, モジュール当り シリコングリスの熱伝導率 = $7 \times 10^{-3} [\text{W}/\text{cm} \cdot ^\circ\text{C}]$	0.09			$^\circ\text{C}/\text{W}$

Forward Characteristics
順方向特性

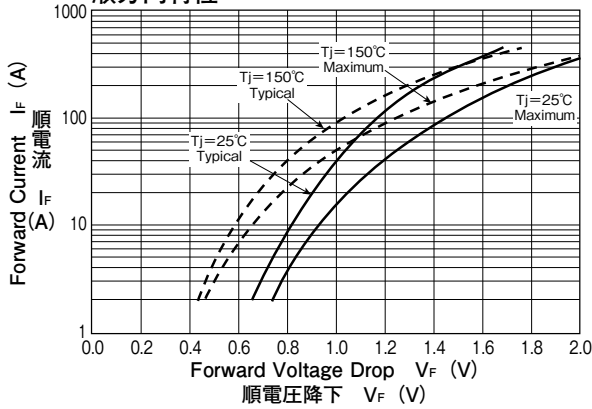

Reverse Recovery Characteristics
逆回復特性

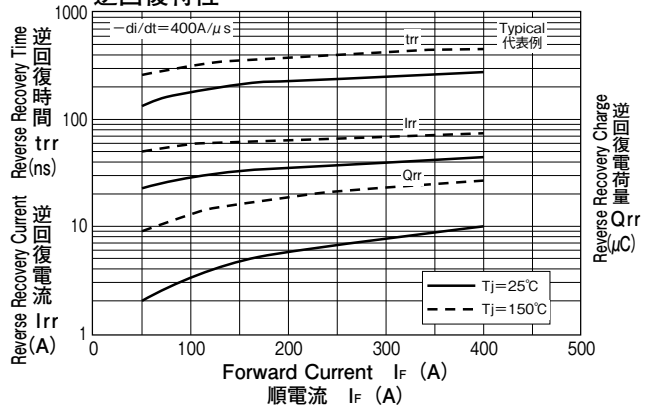

Reverse Recovery Characteristics
逆回復特性

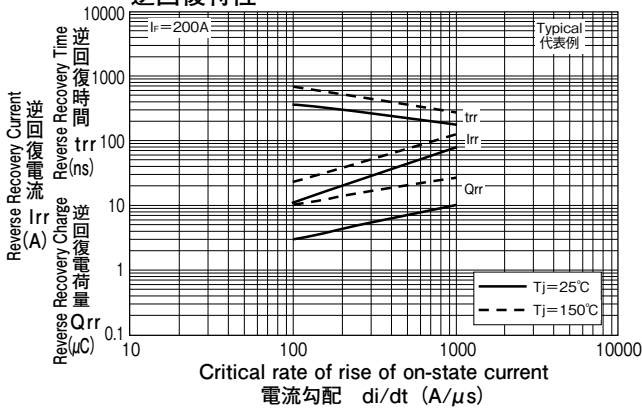

Reverse Characteristics
逆方向特性

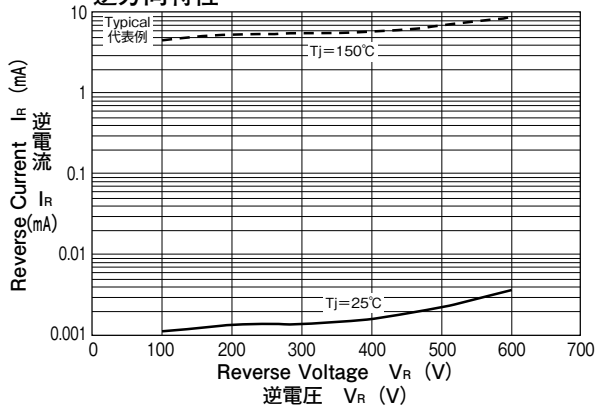

Forward Current vs. Power Dissipation
最大電力損失特性

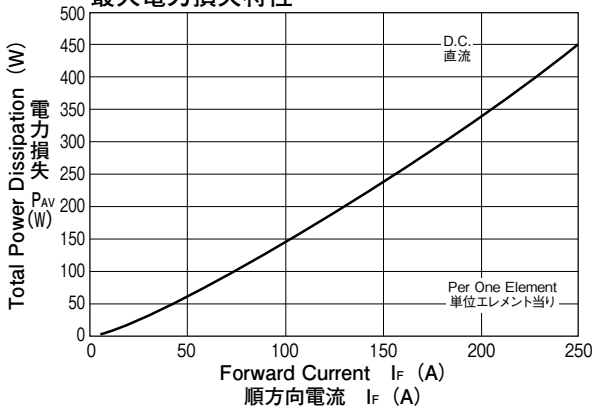

Forward Current vs. Allowable Case Temperature
順方向電流対最大許容ケース温度

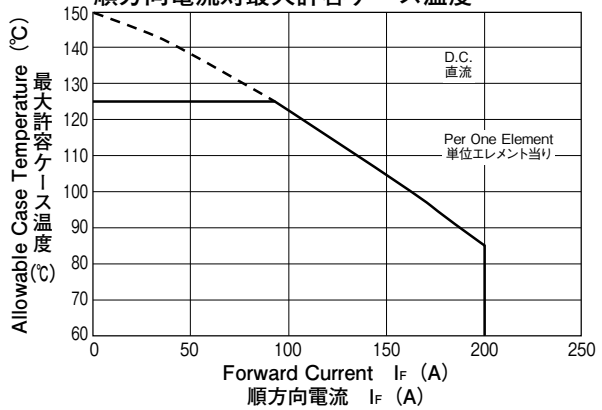

Transient Thermal Impedance
過渡熱インピーダンス特性

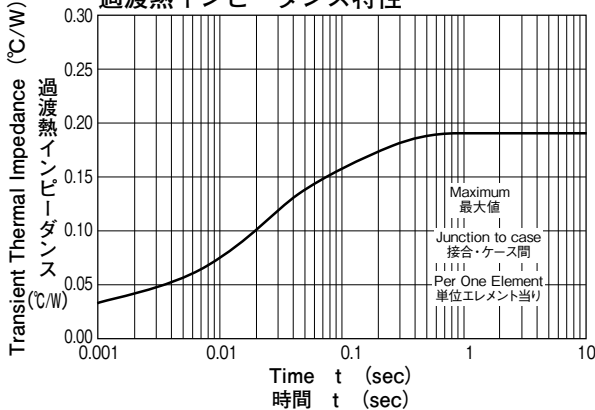

X-ON Electronics

Largest Supplier of Electrical and Electronic Components

Click to view similar products for [Discrete Semiconductor Modules](#) category:

Click to view products by [Sanrex](#) manufacturer:

Other Similar products are found below :

[M252511FV](#) [DD260N12K-A](#) [DD380N16A](#) [DD89N1600K-A](#) [APT2X21DC60J](#) [APT58M80J](#) [B522F-2-YEC](#) [MSTC90-16](#) [25.163.0653.1](#)
[25.163.2453.0](#) [25.163.4253.0](#) [25.190.2053.0](#) [25.194.3453.0](#) [25.320.4853.1](#) [25.320.5253.1](#) [25.326.3253.1](#) [25.326.3553.1](#) [25.330.1653.1](#)
[25.330.4753.1](#) [25.330.5253.1](#) [25.334.3253.1](#) [25.334.3353.1](#) [25.350.2053.0](#) [25.352.4753.1](#) [25.522.3253.0](#) [T483C](#) [T484C](#) [T485F](#) [T485H](#)
[T512F-YEB](#) [T513F](#) [T514F](#) [T554](#) [T612FSE](#) [25.161.3453.0](#) [25.179.2253.0](#) [25.194.3253.0](#) [25.325.1253.1](#) [25.326.4253.1](#) [25.330.0953.1](#)
[25.332.4353.1](#) [25.350.1653.0](#) [25.350.2453.0](#) [25.352.1453.0](#) [25.352.1653.0](#) [25.352.2453.0](#) [25.352.5453.1](#) [25.522.3353.0](#) [25.602.4053.0](#)
[25.640.5053.0](#)