

DIODE MODULE

DD300KB

UL:E76102(M)

Power Diode Module **DD300KB** Series are designed for various rectifier circuits. **DD300KB** has two diode chips connected in series and the mounting base is electrically isolated from elements for simple heatsink construction. Wide voltage rating up to, 1600V is available for various input voltages.

- Isolated mounting base
- Two elements in a package for simple (single and three phase) bridge connections
- Highly reliable glass passivated chips
- High surge current capability

(Applications)

- Various rectifiers, Battery chargers, DC motor drives

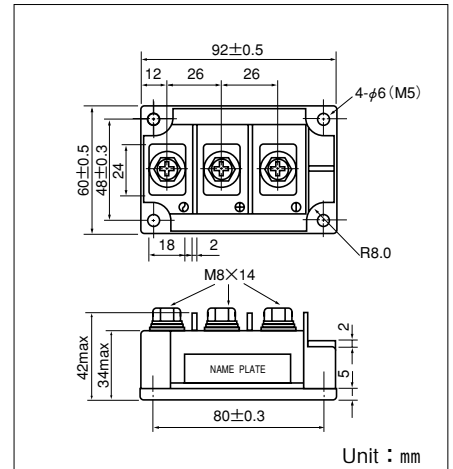
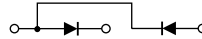

Unit : mm

Maximum Ratings

(T_j=25°C unless otherwise specified)

Symbol	Item	Ratings				Unit
		DD300KB40	DD300KB80	DD300KB120	DD300KB160	
V _{RRM}	Repetitive Peak Reverse Voltage	400	800	1200	1600	V
V _{RSM}	Non-Repetitive Peak Reverse Voltage	480	960	1300	1700	V

Symbol	Item	Conditions	Ratings	Unit	
I _{F(AV)}	Average Forward Current	Single phase, half wave, 180°C conduction, T _c =91°C	300	A	
I _{F(RMS)}	R.M.S. Forward Current	Single phase, half wave, 180°C conduction, T _c =91°C	465	A	
I _{FSM}	Surge Forward Current	½cycle, 60Hz, peak value, non-repetitive	6000	A	
I ² t	I ² t	Value for one cycle of surge current	150000	A ² S	
T _j	Operating Junction Temperature		-40 to +150	°C	
T _{stg}	Storage Temperature		-40 to +125	°C	
V _{ISO}	Isolation Breakdown Voltage (R.M.S.)	A.C. 1minute	2500	V	
	Mounting Torque	Mounting (M5)	Recommended Value 1.5-2.5 (15-25)	2.7 (28)	N·m (kgf·cm)
		Terminal (M8)	Recommended Value 8.8-10.0 (90-105)	11 (115)	
	Mass	Typical Value	510	g	

Electrical Characteristics

Symbol	Item	Conditions	Ratings	Unit
I _{RRM}	Repetitive Peak Reverse Current, max.	T _j =150°C, V _R =V _{RRM}	50	mA
V _{FM}	Forward Voltage Drop, max.	Forward current 750A, Inst measurement	1.50	V
R _{th(j-c)}	Thermal Impedance, max.	Junction to case	0.14	°C/W

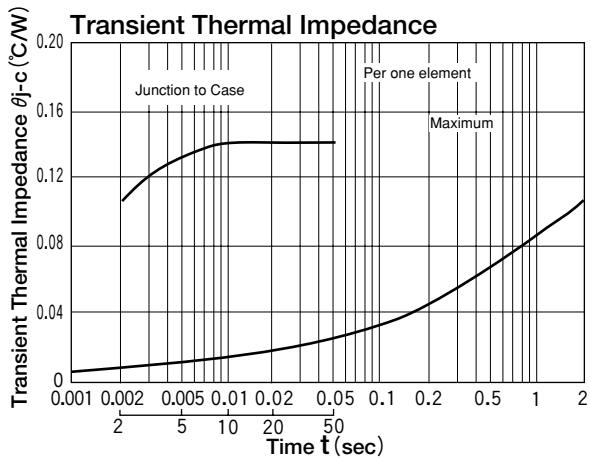
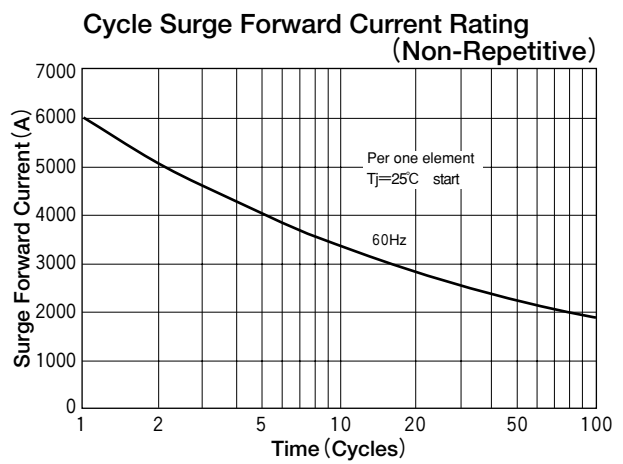
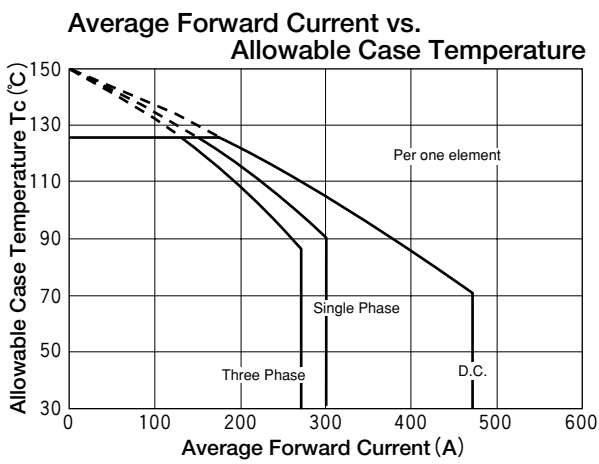
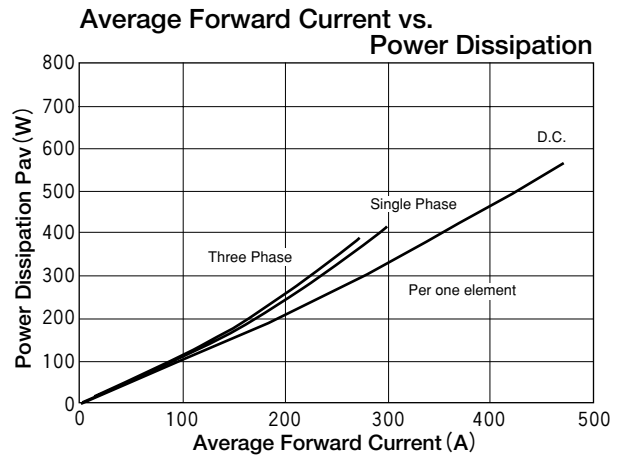
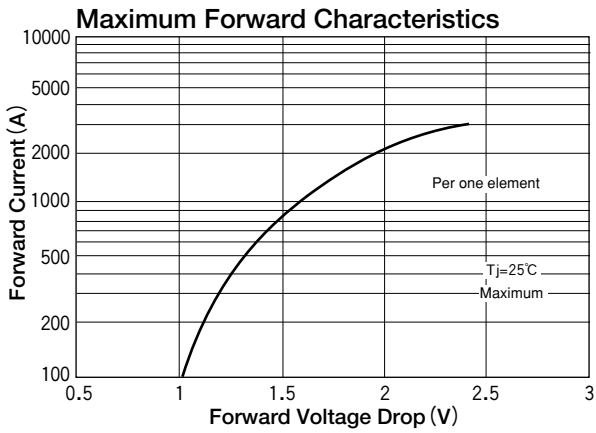

X-ON Electronics

Largest Supplier of Electrical and Electronic Components

Click to view similar products for [Discrete Semiconductor Modules](#) category:

Click to view products by [Sanrex](#) manufacturer:

Other Similar products are found below :

[M252511FV](#) [DD260N12K-A](#) [DD380N16A](#) [DD89N1600K-A](#) [APT2X21DC60J](#) [APT58M80J](#) [B522F-2-YEC](#) [MSTC90-16](#) [25.163.0653.1](#)
[25.163.2453.0](#) [25.163.4253.0](#) [25.190.2053.0](#) [25.194.3453.0](#) [25.320.4853.1](#) [25.320.5253.1](#) [25.326.3253.1](#) [25.326.3553.1](#) [25.330.1653.1](#)
[25.330.4753.1](#) [25.330.5253.1](#) [25.334.3253.1](#) [25.334.3353.1](#) [25.350.2053.0](#) [25.352.4753.1](#) [25.522.3253.0](#) [T483C](#) [T484C](#) [T485F](#) [T485H](#)
[T512F-YEB](#) [T513F](#) [T514F](#) [T554](#) [T612FSE](#) [25.161.3453.0](#) [25.179.2253.0](#) [25.194.3253.0](#) [25.325.1253.1](#) [25.326.4253.1](#) [25.330.0953.1](#)
[25.332.4353.1](#) [25.350.1653.0](#) [25.350.2453.0](#) [25.352.1453.0](#) [25.352.1653.0](#) [25.352.2453.0](#) [25.352.5453.1](#) [25.522.3353.0](#) [25.602.4053.0](#)
[25.640.5053.0](#)