

# 76×30 mm

San Ace B76 9BD type   



## General Specifications

- Material ..... Frame: Plastic (Flammability: UL 94V-0), Impeller: Plastic (Flammability: UL 94V-1)
- Expected life ..... See the table below. (L10 life: 90% survival rate for continuous operation in free air at 60°C, rated voltage)
- Motor protection function ..... Locked rotor burnout protection, Reverse polarity protection  
For details, please refer to p. 547.
- Dielectric strength ..... 50/60 Hz, 500 VAC, for 1 minute (between lead wire conductors and frame)
- Insulation resistance ..... 10 MΩ or more with a 500 VDC megger (between lead wire conductors and frame)
- Sound pressure level (SPL) ..... At 1 m away from the air inlet
- Storage temperature ..... -30 to +70°C (Non-condensing)
- Lead wire ..... ⊕Red ⊖Black or Blue (Sensor) Yellow
- Mass ..... 100 g

## Specifications

The models listed below **have pulse sensors**.

Model no.	Rated voltage [V]	Operating voltage range [V]	Rated current [A]	Rated input [W]	Rated speed [min <sup>-1</sup> ]	Max. airflow [m <sup>3</sup> /min] [CFM]	Max. static pressure [Pa] [inchH <sub>2</sub> O]	SPL [dB (A)]	Operating temperature [°C]	Expected life [h]
<b>109BD12HC2</b>	12	10.2 to 13.8	0.37	4.44	3000	0.36 12.7	151.9 0.61	41.5	-20 to +60	40000/60°C
<b>109BD12FC2</b>			0.27	3.24	2600	0.31 10.9	98 0.394	37		
<b>109BD12MC2</b>			0.14	1.68	2100	0.25 8.8	58.8 0.236	32.5		
<b>109BD24HC2</b>	24	20.4 to 27.6	0.17	4.08	3000	0.36 12.7	151.9 0.61	41.5	-20 to +60	
<b>109BD24FC2</b>			0.14	3.36	2600	0.31 10.9	98 0.394	37	-20 to +70	
<b>109BD24MC2</b>			0.1	2.4	2100	0.25 8.8	58.8 0.236	32.5	-20 to +70	

The following sensor and control options are available for selection.

Available for all models. **Without sensor** **Lock sensor**

Differs according to the model. Refer to the table on p. 561. **PWM control**

## Airflow - Static Pressure Characteristics

**109BD12HC2** With pulse sensor

Operating voltage range

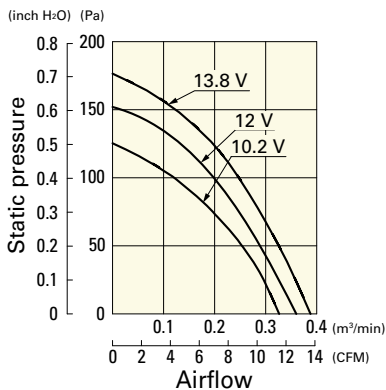

**109BD12FC2** With pulse sensor

Operating voltage range

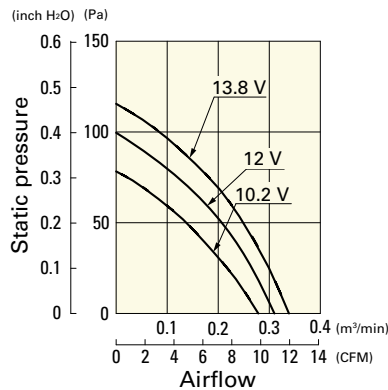

**109BD12MC2** With pulse sensor

Operating voltage range

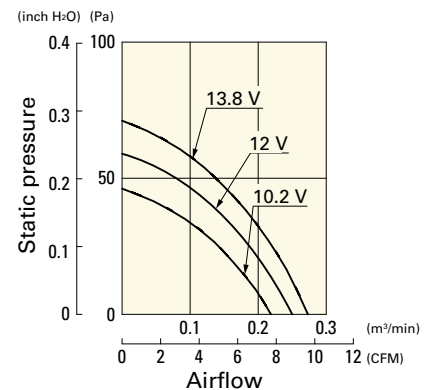

## Airflow - Static Pressure Characteristics

**109BD24HC2** With pulse sensor

Operating voltage range

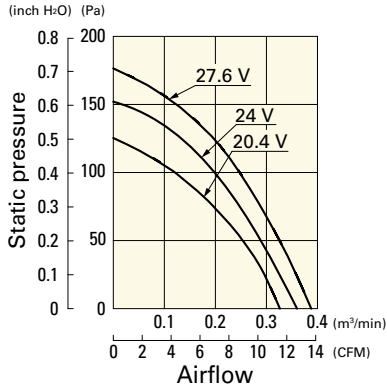

**109BD24FC2** With pulse sensor

Operating voltage range

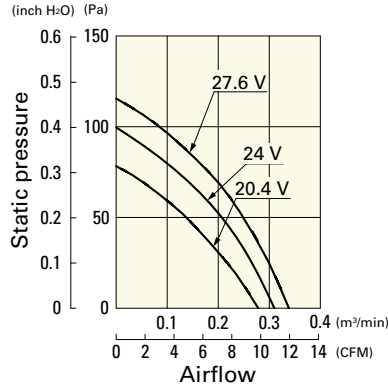

**109BD24MC2** With pulse sensor

Operating voltage range

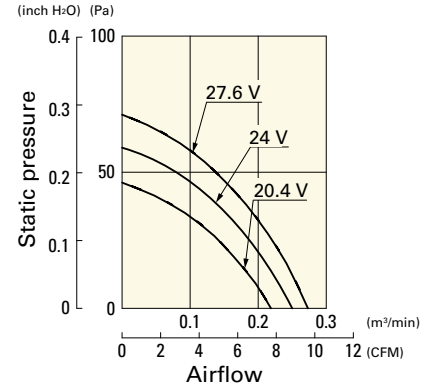

## Dimensions (unit: mm)

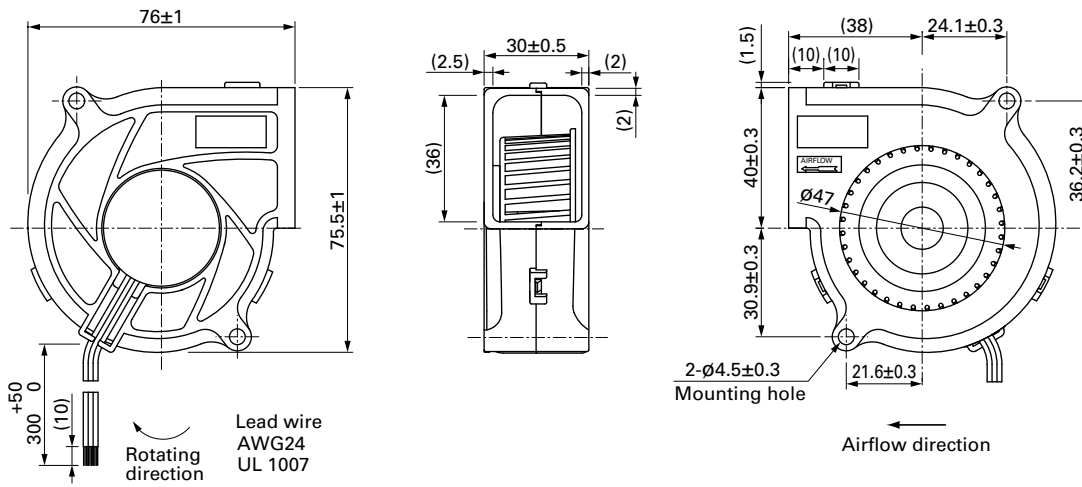

Blower 76 mm DC

## X-ON Electronics

Largest Supplier of Electrical and Electronic Components

*Click to view similar products for [Blowers & Centrifugal Fans](#) category:*

*Click to view products by [Sanyo Denki](#) manufacturer:*

Other Similar products are found below :

[MKEL-DRB](#) [R2D140-AB02-14](#) [R2D160-AC02-13](#) [R4D310-AS18-01](#) [R4D400-AD22-06](#) [R4E180-AS11-09](#) [R4S175-AA16-12](#) [AIF60112](#)  
[AIF801724](#) [RLF35-812N2P-103](#) [DOP-EXI014RAE](#) [KFB1724VHT-AF00](#) [KFC1048DS-S45D](#) [AIF641714](#) [CME-COP01](#) [R1G220-AB07-09](#)  
[R2E180CH0312](#) [R2S150-AD08-09](#) [RD20S-4/210660](#) [RH56M-6/204689](#) [D2E146-CD51-09](#) [TP04G-AS2](#) [TP05G-BT2](#) [TP-PCC](#) [BR200W250](#)  
[D4E133-AA01-51](#) [DFD0612H/SPECTRA](#) [DOP-EXI028RAE](#) [55462.19890](#) [K1G200-AA73-02](#) [G2D160-AF02-01](#) [G2E150-BA52-07](#)  
[G2S150-AB56-42](#) [D4E225-BC01-02](#) [R2D225-AV02-14](#) [D2E146-HT67-63](#) [K1G220-AA67-02](#) [G2E140-AG02-05](#) [R3G190-AB23-02](#)  
[55410.91750](#) [55462.19891](#) [G3G160-AC70-01](#) [R1G120-AD17-11](#) [R3G250-AM70-01](#) [R2E225-RA02-47](#) [RER225-63/18/2TDMP](#) [R4E310-](#)  
[AO12-14](#) [D2E146-HT65-64](#) [3612751](#) [G2D140-AC30-18](#)