

40×40×20 mm

San Ace 40 9P type   



General Specifications

- Material Frame: Plastic (Flammability: UL 94V-0), Impeller: Plastic (Flammability: UL 94V-1)
- Expected life See the table below. (L10 life: 90% survival rate for continuous operation in free air at 60°C, rated voltage)
- Motor protection function Locked rotor burnout protection, Reverse polarity protection
For details, please refer to p. 547.
- Dielectric strength 50/60 Hz, 500 VAC, for 1 minute (between lead wire conductors and frame)
- Insulation resistance 10 MΩ or more with a 500 VDC megger (between lead wire conductors and frame)
- Sound pressure level (SPL) At 1 m away from the air inlet
- Storage temperature -30 to +70°C (Non-condensing)
- Lead wire ⊕Red ⊖Black or Blue (Sensor) Yellow
- Mass 45 g

Specifications

The models listed below **have ribs and pulse sensors.**

Model no.	Rated voltage [V]	Operating voltage range [V]	Rated current [A]	Rated input [W]	Rated speed [min ⁻¹]	Max. airflow [m ³ /min] [CFM]	Max. static pressure [Pa] [inchH ₂ O]	SPL [dB (A)]	Operating temperature [°C]	Expected life [h]
109P0405J601	5	4.5 to 5.5	0.46	2.3	9800	0.28 9.9	98.5 0.396	39	-20 to +70	40000/60°C
109P0405H601			0.32	1.6	8000	0.225 8.0	65.7 0.264	33		
109P0405F601			0.25	1.25	6500	0.183 6.5	45.1 0.181	28		
109P0405M601			0.12	0.6	5000	0.136 4.8	26.5 0.106	24		
109P0412G601	12	7 to 13.8	0.28	3.36	12500	0.35 12.4	153.8 0.618	44	-20 to +60	40000/60°C
109P0412D601			0.18	2.16	11000	0.31 10.9	124 0.498	42		
109P0412E601			0.13	1.56	9200	0.26 9.2	87.3 0.351	37		
109P0412H601			0.11	1.32	8000	0.225 8.0	65.7 0.264	33		
109P0412F601			0.09	1.08	6500	0.183 6.5	45.1 0.181	28		
109P0412M601	8 to 13.8	0.06	0.72	5000	0.136 4.8	26.5 0.106	24			
109P0424G601	24	12 to 27.6	0.15	3.6	12500	0.35 12.4	153.8 0.618	44	-20 to +60	40000/60°C
109P0424D601		12 to 27.6	0.13	3.12	11000	0.31 10.9	124 0.498	42		
109P0424H601		12 to 27.6	0.07	1.68	8300	0.233 8.2	69.6 0.28	35		
109P0424F601		14 to 27.6	0.06	1.44	6500	0.183 6.5	45.1 0.181	28		
109P0424B601		20.4 to 27.6	0.06	1.44	5200	0.14 4.9	28.3 0.114	25		

The following sensor and control options are available for selection.

Available for all models. **Without sensor**

Differs according to the model. Refer to the table on pp. 562 to 563. **Lock sensor**

Airflow - Static Pressure Characteristics

109P0405J601 With pulse sensor

Operating voltage range

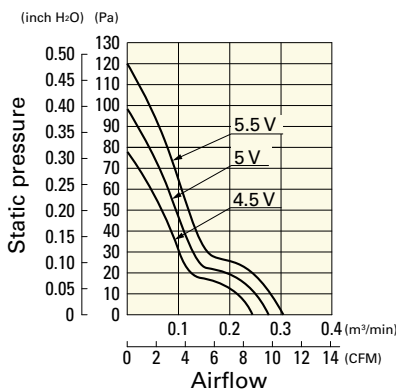

109P0405H601 With pulse sensor

Operating voltage range

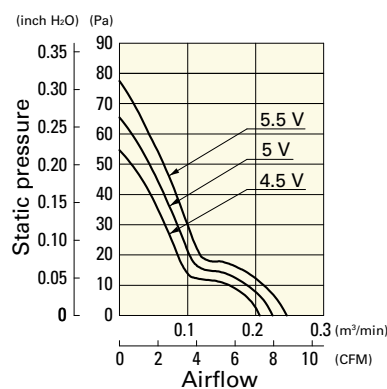

109P0405F601 With pulse sensor

Operating voltage range

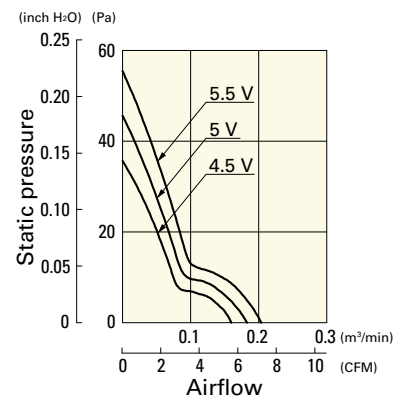

Airflow - Static Pressure Characteristics

109P0405M601 With pulse sensor

Operating voltage range

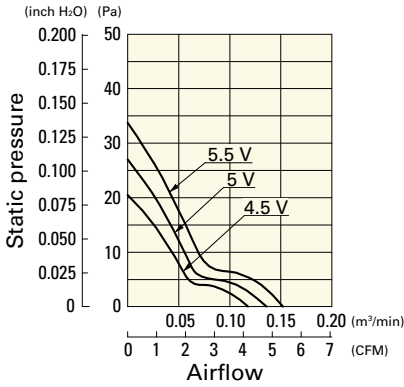

109P0412G601 With pulse sensor

Operating voltage range

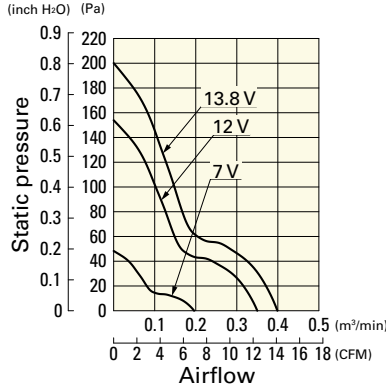

109P0412D601 With pulse sensor

Operating voltage range

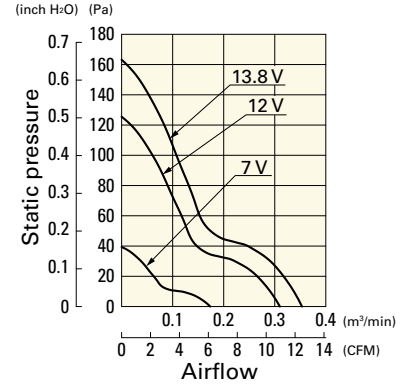

109P0412E601 With pulse sensor

Operating voltage range

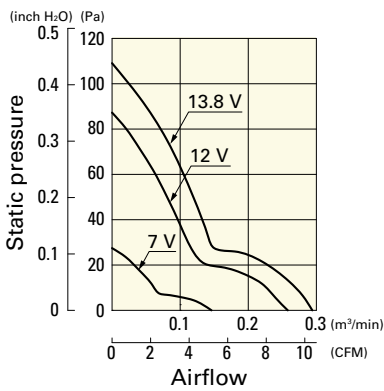

109P0412H601 With pulse sensor

Operating voltage range

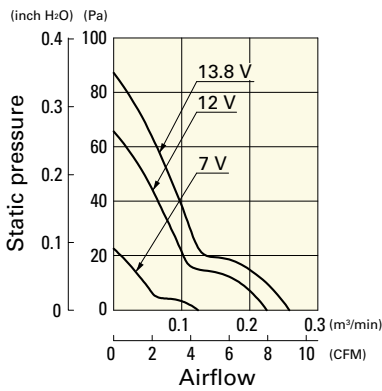

109P0412F601 With pulse sensor

Operating voltage range

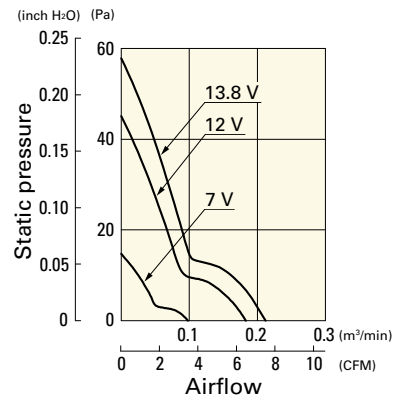

109P0412M601 With pulse sensor

Operating voltage range

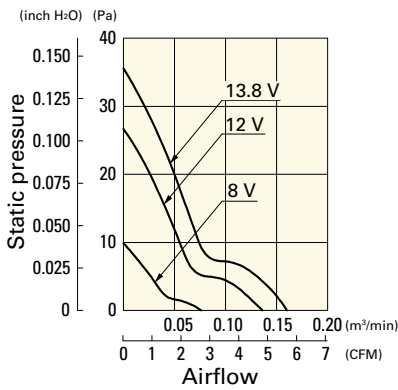

109P0424G601 With pulse sensor

Operating voltage range

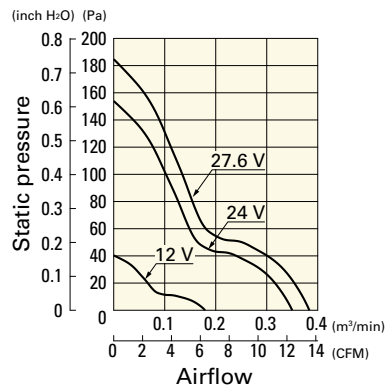

109P0424D601 With pulse sensor

Operating voltage range

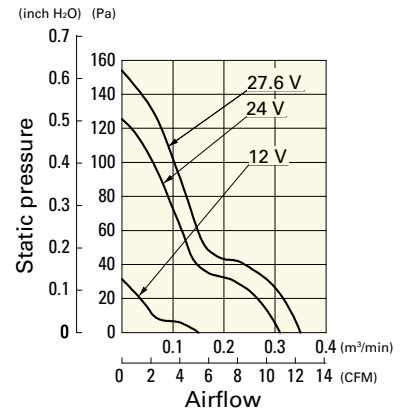

109P0424H601 With pulse sensor

Operating voltage range

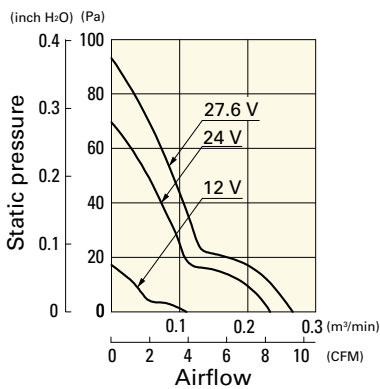

109P0424F601 With pulse sensor

Operating voltage range

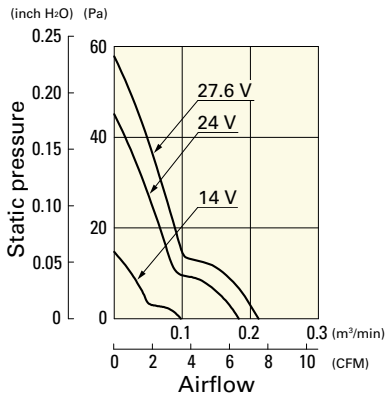

109P0424B601 With pulse sensor

Operating voltage range

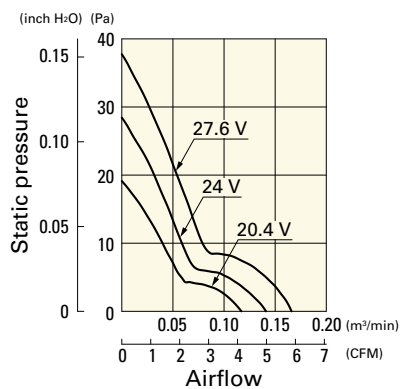

Dimensions (unit: mm)

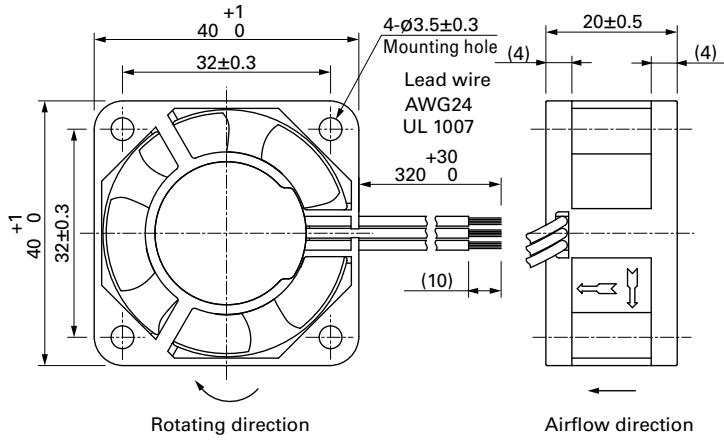

Reference Dimensions of Mounting Holes and Vent Opening (unit: mm)

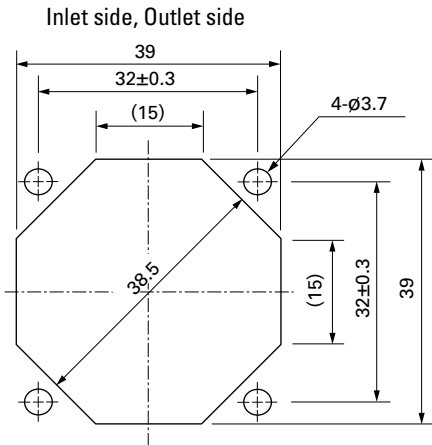

Options

Finger guards

page: p. 532

Model no.: 109-059, 109-059H

X-ON Electronics

Largest Supplier of Electrical and Electronic Components

Click to view similar products for [DC Fans](#) category:

Click to view products by [Sanyo Denki](#) manufacturer:

Other Similar products are found below :

[614R](#) [AUB0612L](#) [AFB0948HH-S687](#) [G2E085-AA05-10](#) [4318/12T](#) [AUB0912H-F00](#) [3412N/2ME](#) [W2G110-AM39-01](#) [8412GLV](#) [8412NGL-12](#) [6448-384](#) [4114N/17-251](#) [4318/2R](#) [4412F/2D](#) [424JMU](#) [4414/2HH](#) [4112 N/12GL-175](#) [9GA0912F402](#) [9GA0812B20011](#)
[AFB0824SHBAV1](#) [DV5214/2NP-230](#) [9GA0912H4021](#) [THC1548MGDJJ](#) [9GA0812B2001](#) [GFB1224SHG](#) [8500NU](#) [9WG1212E101-E](#)
[3241.124](#) [DC1203812W2B-2T0](#) [MF40060V1-1000U-G99](#) [DC0401012V2B-3T0](#) [ASFP14391](#) [ASFP64371](#) [ASFP64391](#) [ASFP84391](#)
[ASFP92391](#) [9A0612G402](#) [AD5012HB-C71](#) [AD5012MB-C71](#) [ASFP84372](#) [ASFP64372](#) [31100-000440-RS](#) [026758A](#) [514F](#) [MEC0381V1-000U-G99](#) [4292](#) [MF40101V2-1000U-A99](#) [MF60152V1-1000U-G99](#) [3610KL-04W-B50-D00](#) [109P0412K3023](#)