

40x40x15 mm

San Ace 40 9P type   



General Specifications

- Material Frame: Plastic (Flammability: UL 94V-0), Impeller: Plastic (Flammability: UL 94V-1)
- Expected life See the table below. (L10 life: 90% survival rate for continuous operation in free air at 60°C, rated voltage)
- Motor protection function Locked rotor burnout protection, Reverse polarity protection
For details, please refer to p. 547.
- Dielectric strength 50/60 Hz, 500 VAC, for 1 minute (between lead wire conductors and frame)
- Insulation resistance 10 MΩ or more with a 500 VDC megger (between lead wire conductors and frame)
- Sound pressure level (SPL) At 1 m away from the air inlet
- Storage temperature -30 to +70°C (Non-condensing)
- Lead wire ⊕Red ⊖Black or Blue (Sensor) Yellow
- Mass 32 g

Specifications

The models listed below **have ribs and pulse sensors.**

Model no.	Rated voltage [V]	Operating voltage range [V]	Rated current [A]	Rated input [W]	Rated speed [min ⁻¹]	Max. airflow [m ³ /min] [CFM]	Max. static pressure [Pa] [inchH ₂ O]	SPL [dB (A)]	Operating temperature [°C]	Expected life [h]	
109P0405H701	5	4.5 to 5.5	0.28	1.4	7700	0.18 6.4	75.5 0.303	28	-20 to +60	60000/60°C	
109P0405M701			0.21	1.05	6500	0.15 5.3	52.9 0.213	24			
109P0412R701	12	7 to 13.8	0.13	1.56	9700	0.227 8.0	111.9 0.449	34		-20 to +70	40000/60°C
109P0412S701			0.18	2.16	8600	0.2 7.06	92.1 0.369	32			
109P0412H701			0.13	1.56	7700	0.18 6.4	75.5 0.303	28			
109P0412M701			0.095	1.14	6500	0.15 5.3	52.9 0.213	24			
109P0424H701			24	20.4 to 27.6	0.08	1.92	7700	0.18 6.4	75.5 0.303		

The following sensor and control options are available for selection.

Available for all models. Without sensor Lock sensor

Airflow - Static Pressure Characteristics

109P0405H701 With pulse sensor

Operating voltage range

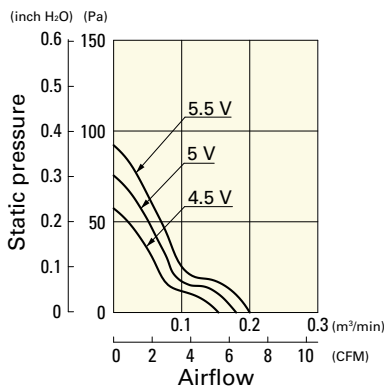

109P0405M701 With pulse sensor

Operating voltage range

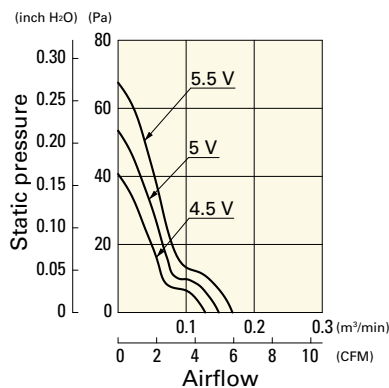

109P0412R701 With pulse sensor

Operating voltage range

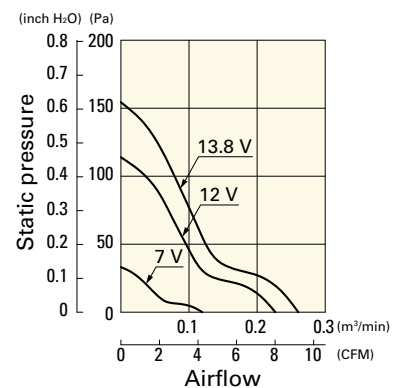

Airflow - Static Pressure Characteristics

109P0412S701 With pulse sensor

Operating voltage range

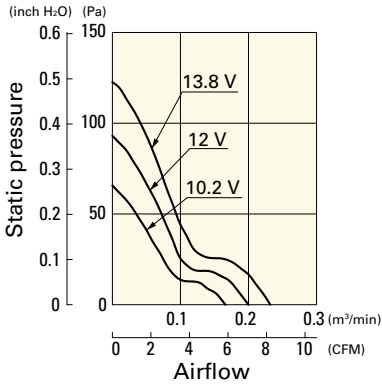

109P0412H701 With pulse sensor

Operating voltage range

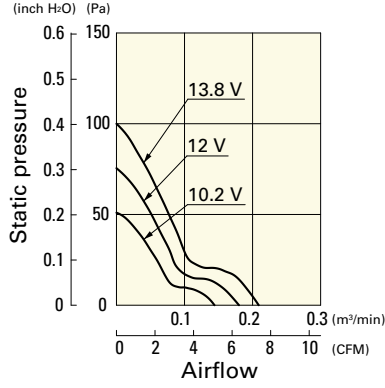

109P0412M701 With pulse sensor

Operating voltage range

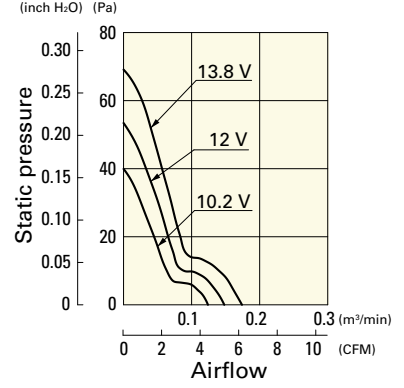

109P0424H701 With pulse sensor

Operating voltage range

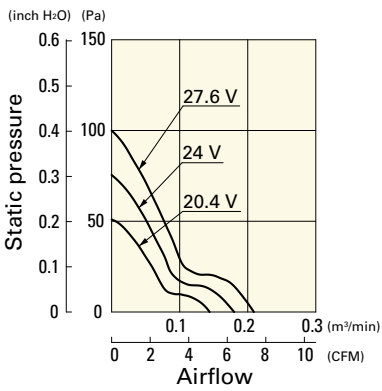

Dimensions (unit: mm)

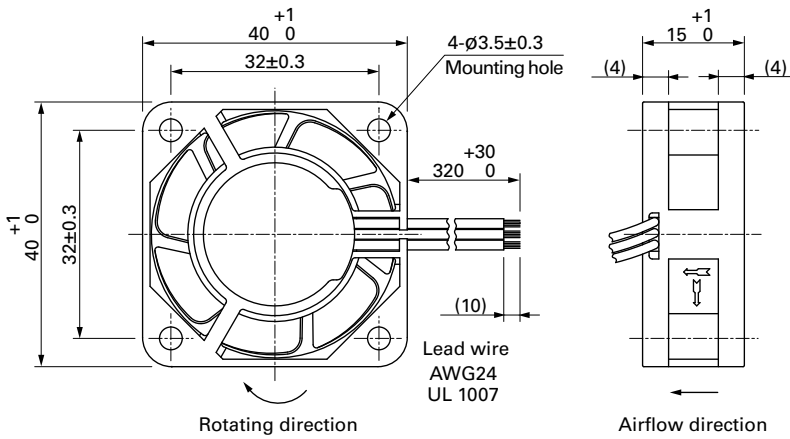

Reference Dimensions of Mounting Holes and Vent Opening (unit: mm)

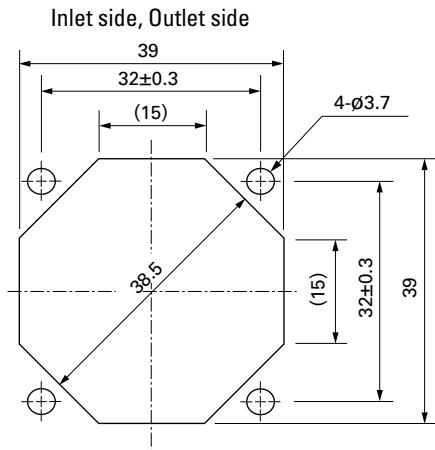

Options

Finger guards

page: p. 532

Model no.: 109-059, 109-059H

X-ON Electronics

Largest Supplier of Electrical and Electronic Components

Click to view similar products for [DC Fans](#) category:

Click to view products by [Sanyo Denki](#) manufacturer:

Other Similar products are found below :

[614R](#) [AUB0612L](#) [AFB0948HH-S687](#) [G2E085-AA05-10](#) [4318/12T](#) [AUB0912H-F00](#) [3412N/2ME](#) [W2G110-AM39-01](#) [8412GLV](#) [8412NGL-12](#) [6448-384](#) [4114N/17-251](#) [4318/2R](#) [4412F/2D](#) [424JMU](#) [4414/2HH](#) [4112 N/12GL-175](#) [9GA0912F402](#) [9GA0812B20011](#)
[AFB0824SHBAV1](#) [DV5214/2NP-230](#) [9GA0912H4021](#) [THC1548MGDJJ](#) [9GA0812B2001](#) [GFB1224SHG](#) [8500NU](#) [9WG1212E101-E](#)
[3241.124](#) [DC0401012V2B-3T0](#) [ASFP14391](#) [ASFP64371](#) [ASFP64391](#) [ASFP84391](#) [ASFP92391](#) [9A0612G402](#) [AD5012HB-C71](#)
[AD5012MB-C71](#) [ASFP84372](#) [ASFP64372](#) [31100-000440-RS](#) [026758A](#) [514F](#) [MEC0381V1-000U-G99](#) [4292](#) [MF60152V1-1000U-G99](#)
[3610KL-04W-B50-D00](#) [109P0412K3023](#) [EE92251B1-000U-F99](#) [8218J/2H4P](#) [PF60381B1-000U-S99](#)