



DC Fan

# 80×80×25 mm

San Cooler 80 9A type   



## General Specifications

- Material ..... Frame: Plastic (Flammability: UL 94V-0), Impeller: Plastic (Flammability: UL 94V-0)
- Expected life ..... See the table below. (L10 life: 90% survival rate for continuous operation in free air at 60°C, rated voltage)  
Expected life at 40°C is for reference only.
- Motor protection function ..... Locked rotor burnout protection, Reverse polarity protection  
For details, please refer to p. 573.
- Dielectric strength ..... 50/60 Hz, 500 VAC, for 1 minute (between lead wire conductors and frame)
- Insulation resistance ..... 10 MΩ or more with a 500 VDC megger (between lead wire conductors and frame)
- Sound pressure level (SPL) ..... At 1 m away from the air inlet
- Storage temperature ..... -30 to +70°C (Non-condensing)
- Lead wire ..... ⊕Red ⊖Black or Blue Sensor Yellow
- Mass ..... 90 g

## Specifications

The models listed below **have ribs and pulse sensors**. For models without ribs, append "1" to the end of model numbers.

Model no.	Rated voltage [V]	Operating voltage range [V]	Rated current [A]	Rated input [W]	Rated speed [min <sup>-1</sup> ]	Max. airflow [m <sup>3</sup> /min] [CFM]	Max. static pressure [Pa] [inchH <sub>2</sub> O]	SPL [dB (A)]	Operating temperature [°C]	Expected life [h]		
9A0812G401	12	6 to 13.2	0.38	4.56	4500	1.5 53.0	80.3 0.323	40	-20 to +60	30000/60°C (53000/40°C)		
9A0812S401			0.18	2.16	3400	1.2 42.4	48 0.193	34				
9A0812H401		6 to 13.8	0.13	1.56	2900	1.03 36.4	35.3 0.142	29			-20 to +70	40000/60°C (70000/40°C)
9A0812F401			0.11	1.32	2600	0.92 32.5	28.4 0.114	26				
9A0812M401			0.09	1.08	2350	0.83 29.3	22.5 0.09	23				
9A0812L401			0.06	0.72	1850	0.65 23.0	14.7 0.059	20				
9A0824G401	24	12 to 26.4	0.21	5.04	4500	1.5 53.0	80.3 0.323	40	-20 to +60	30000/60°C (53000/40°C)		
9A0824S401			0.1	2.4	3400	1.2 42.4	48 0.193	34				
9A0824H401		12 to 27.6	0.07	1.68	2900	1.03 36.4	35.3 0.142	29			-20 to +70	40000/60°C (70000/40°C)
9A0824F401			0.06	1.44	2600	0.92 32.5	28.4 0.114	26				
9A0824M401			0.05	1.2	2350	0.83 29.3	22.5 0.09	23				
9A0824L401			0.04	0.96	1850	0.65 23.0	14.7 0.059	20				

The following sensor and control options are available for selection.

Available for all models. Without sensor Lock sensor

Differs according to the model. Refer to the table on p. 598. PWM control

The ⌘ mark indicates Short LeadTime Service applicable models. See p. 626 for details.

## Airflow - Static Pressure Characteristics

**9A0812G401** With pulse sensor

Operating voltage range

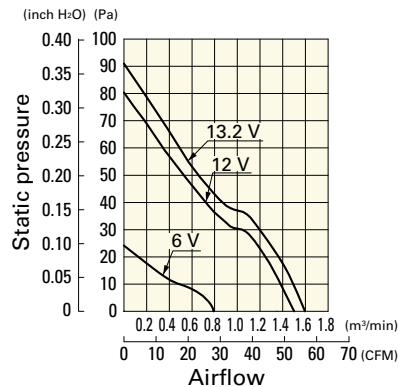

**9A0812S401** With pulse sensor

Operating voltage range

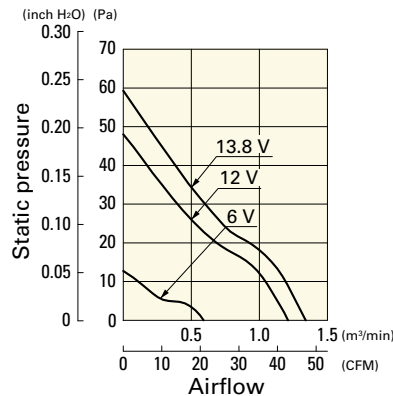

**9A0812H401** With pulse sensor

Operating voltage range

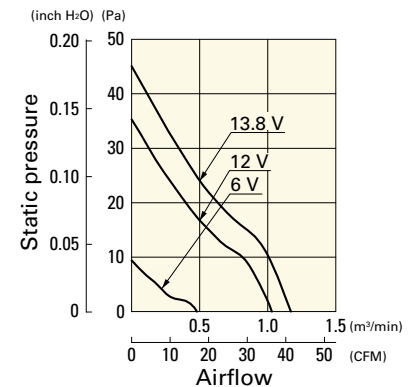

# Airflow - Static Pressure Characteristics

**9A0812F401** With pulse sensor

Operating voltage range

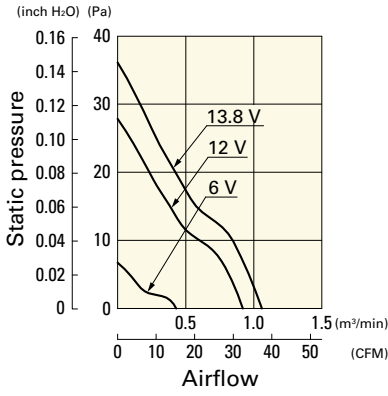

**9A0812M401** With pulse sensor

Operating voltage range

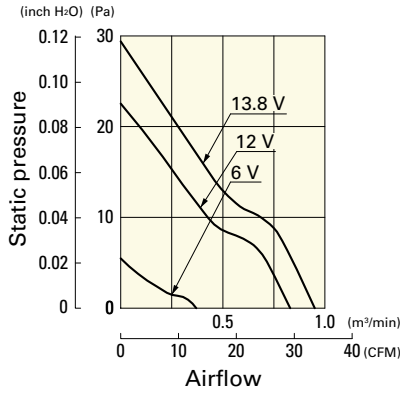

**9A0812L401** With pulse sensor

Operating voltage range

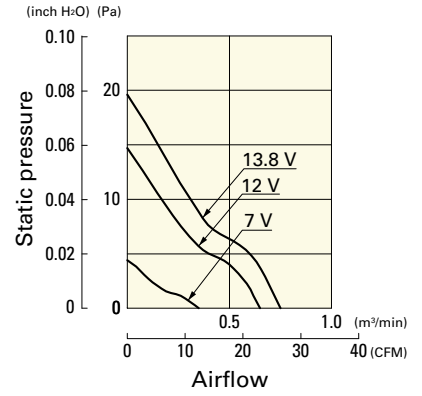

**9A0824G401** With pulse sensor

Operating voltage range

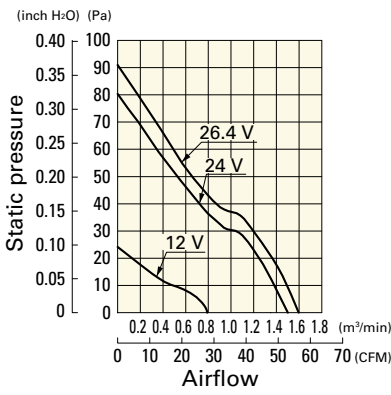

**9A0824S401** With pulse sensor

Operating voltage range

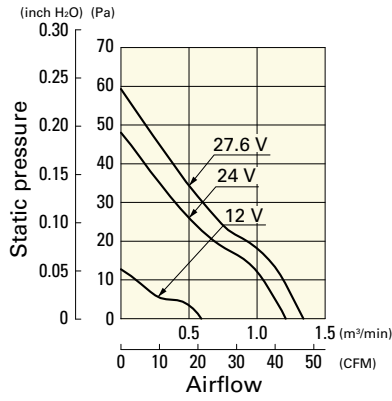

**9A0824H401** With pulse sensor

Operating voltage range

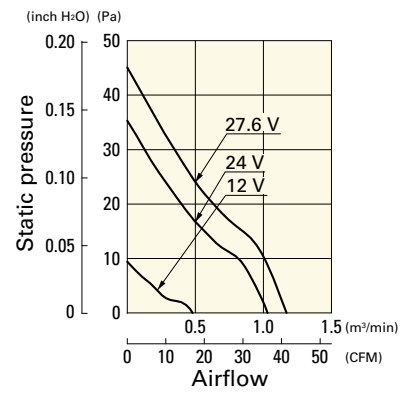

**9A0824F401** With pulse sensor

Operating voltage range

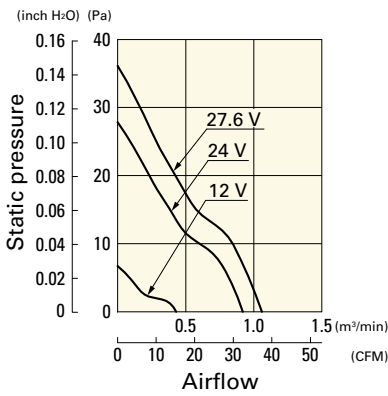

**9A0824M401** With pulse sensor

Operating voltage range

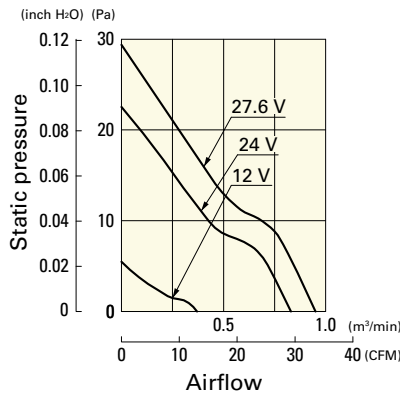

**9A0824L401** With pulse sensor

Operating voltage range

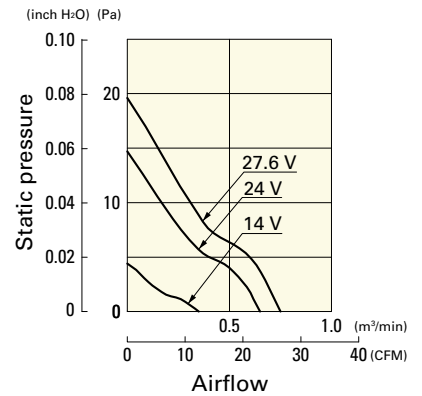

**Dimensions (unit: mm)** (With ribs)

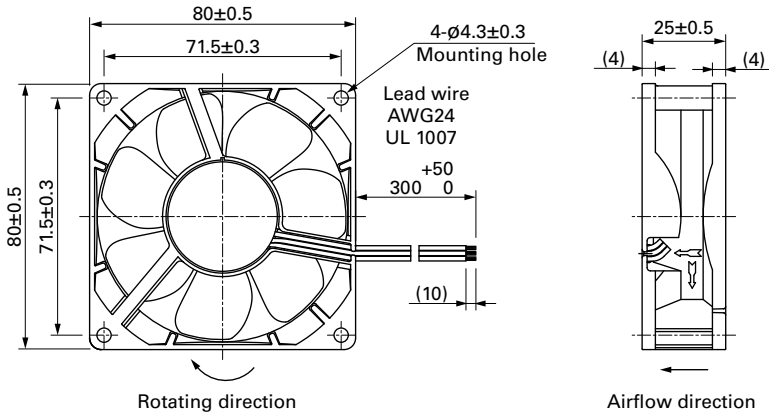

**Reference Dimensions of Mounting Holes and Vent Opening (unit: mm)**

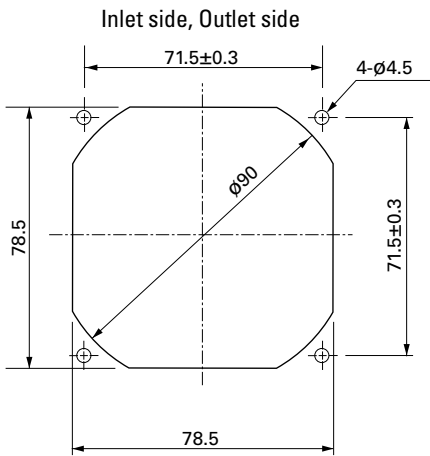

**Options**

**Finger guards**

page: p. 558

Model no.: 109-049E, 109-049H, 109-049C

**Resin finger guards**

page: p. 565

Model no.: 109-1002G

**Resin filter kits**

page: p. 566

Model no.: 109-1002F13 (13PPI), 109-1002F20 (20PPI),  
109-1002F30 (30PPI), 109-1002F40 (40PPI)

## X-ON Electronics

Largest Supplier of Electrical and Electronic Components

*Click to view similar products for [DC Fans](#) category:*

*Click to view products by [Sanyo Denki](#) manufacturer:*

Other Similar products are found below :

[AUB0612L](#) [AFB0948HH-S687](#) [G2E085-AA05-10](#) [4318/12T](#) [AUB0912H-F00](#) [3412N/2ME](#) [W2G110-AM39-01](#) [8412GLV](#) [8412NGL-12](#)  
[6448-384](#) [4114N/17-251](#) [4318/2R](#) [4412F/2D](#) [424JMU](#) [4414/2HH](#) [4112 N/12GL-175](#) [9GA0924L4021](#) [9GA0924M4021](#) [9GA0924M4011](#)  
[9GA0812A2D0011](#) [9GA0912M4D011](#) [9GA0924W4D01](#) [9GA0912F4021](#) [9GA0912F402](#) [9GA0912H4D011](#) [9GA0824L20021](#)  
[9GA0824L20011](#) [9GA0812A2002](#) [9GA0812B20011](#) [9GA0812B2D001](#) [9GA0812L20021](#) [9WP1248M1021](#) [9GA0812A2D001](#)  
[9GA0824L2D001](#) [9GA0924W4D011](#) [9GA0912W402](#) [9GA0912M402](#) [9GA0824B2D001](#) [9GA0824A20021](#) [9GA0912W4021](#)  
[9GA0924W402](#) [9GA0812L2D0011](#) [9GA0812A20021](#) [9GA0824B2D0011](#) [9GA0824L2001](#) [9GA0824L2002](#) [9GA0812L2D001](#)  
[9GA0824L2D0011](#) [9GA0912M401](#) [9GA0924M402](#)