

# 76x20 mm

San Ace B76 9BD type 



## General Specifications

- Material ..... Frame: Plastic (Flammability: UL 94V-0), Impeller: Plastic (Flammability: UL 94V-0)
- Expected life ..... See the table below. (L10 life: 90% survival rate for continuous operation in free air at 60°C, rated voltage)  
Expected life at 40°C is for reference only.
- Motor protection function ..... Locked rotor burnout protection, Reverse polarity protection  
For details, please refer to p. 573.
- Dielectric strength ..... 50/60 Hz, 500 VAC, for 1 minute (between lead wire conductors and frame)
- Insulation resistance ..... 10 MΩ or more with a 500 VDC megger (between lead wire conductors and frame)
- Sound pressure level (SPL) ..... At 1 m away from the air inlet
- Storage temperature ..... -30 to +70°C (Non-condensing)
- Lead wire ..... ⊕Red ⊖Black Sensor Yellow
- Mass ..... 58 g

## Specifications

The models listed below **have pulse sensors**.

Model no.	Rated voltage [V]	Operating voltage range [V]	Rated current [A]	Rated input [W]	Rated speed [min <sup>-1</sup> ]	Max. airflow [m <sup>3</sup> /min] [CFM]	Max. static pressure [Pa] [inchH <sub>2</sub> O]	SPL [dB (A)]	Operating temperature [°C]	Expected life [h]
9BD12SC6-1	12	5 to 13.8	0.28	3.36	4500	0.29 10.2	300 1.2	43	-20 to +70	40000/60°C (70000/40°C)
9BD12HC6-1			0.21	2.52	4200	0.27 9.5	230 0.92	41		
9BD12FC6-1		0.18	2.16	3900	0.25 8.8	200 0.8	39			
9BD24SC6-1	24	10 to 27.6	0.14	3.36	4500	0.29 10.2	300 1.2	43		
9BD24HC6-1			0.12	2.88	4200	0.27 9.5	230 0.92	41		
9BD24FC6-1			0.1	2.4	3900	0.25 8.8	200 0.8	39		

The following sensor and control options are available for selection.

Available for all models. Without sensor Lock sensor

Differs according to the model. Refer to the table on p. 599. PWM control

The  mark indicates Short LeadTime Service applicable models. See p. 626 for details.

## Airflow - Static Pressure Characteristics

9BD12SC6-1 With pulse sensor

Operating voltage range

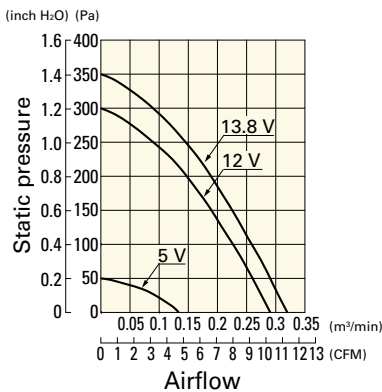

9BD12HC6-1 With pulse sensor

Operating voltage range

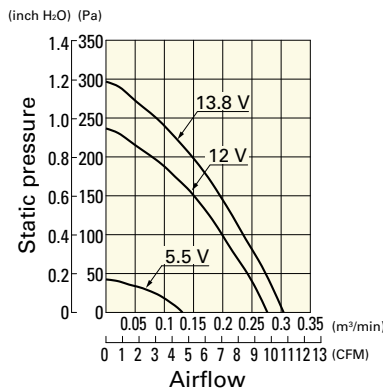

9BD12FC6-1 With pulse sensor

Operating voltage range

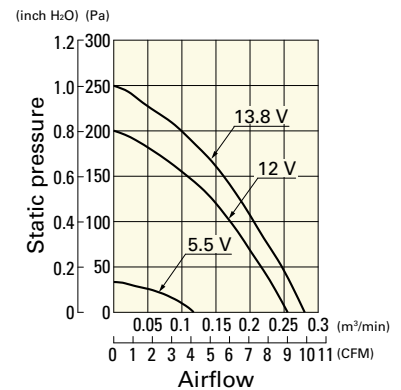

## Airflow - Static Pressure Characteristics

**9BD24SC6-1** With pulse sensor

Operating voltage range

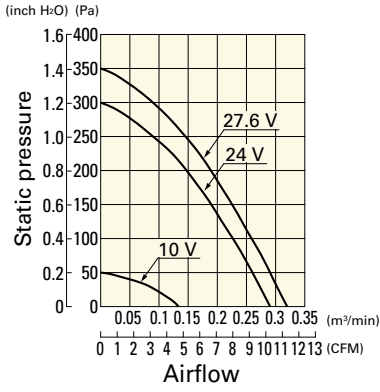

**9BD24HC6-1** With pulse sensor

Operating voltage range

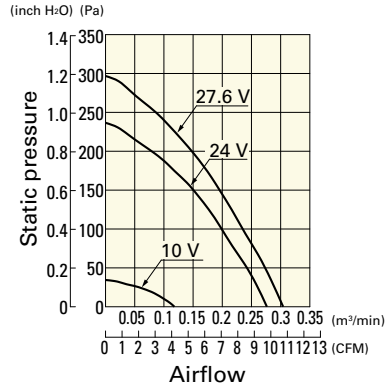

**9BD24FC6-1** With pulse sensor

Operating voltage range

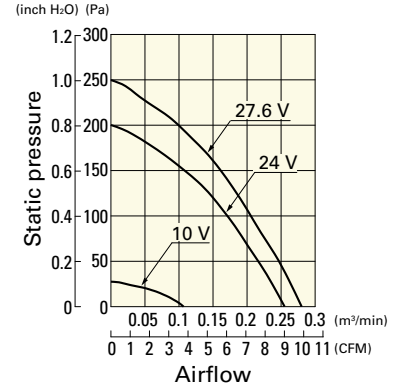

## Dimensions (unit: mm)

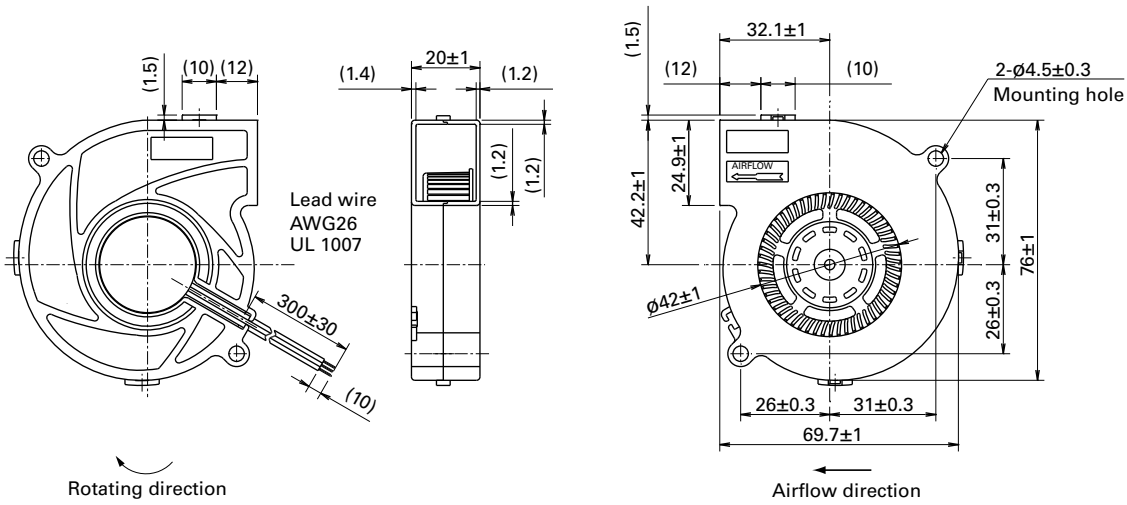

Blower 76 mm DC

## X-ON Electronics

Largest Supplier of Electrical and Electronic Components

*Click to view similar products for [Blowers & Centrifugal Fans](#) category:*

*Click to view products by [Sanyo Denki](#) manufacturer:*

Other Similar products are found below :

[MKEL-DRB](#) [R2D140-AB02-14](#) [R2D160-AC02-13](#) [R4D310-AS18-01](#) [R4D400-AD22-06](#) [R4E180-AS11-09](#) [R4S175-AA16-12](#) [AIF60112](#)  
[AIF801724](#) [DOP-EXI014RAE](#) [KFB1724VHT-AF00](#) [KFC1048DS-S45D](#) [AIF641714](#) [CME-COP01](#) [R1G220-AB07-09](#) [R2E180CH0312](#)  
[R2S150-AD08-09](#) [RD20S-4/210660](#) [RH56M-6/204689](#) [D2E146-CD51-09](#) [TP04G-AS2](#) [TP05G-BT2](#) [TP-PCC](#) [BR200W250](#) [D4E133-AA01-](#)  
[51](#) [DFD0612H/SPECTRA](#) [DOP-EXI028RAE](#) [Z4.802.1680.0](#) [55462.19890](#) [K1G200-AA73-02](#) [G2D160-AF02-01](#) [G2E150-BA52-07](#)  
[G2S150-AB56-42](#) [D4E225-BC01-02](#) [R2D225-AV02-14](#) [D2E146-HT67-63](#) [K1G220-AA67-02](#) [R3G190-AB23-02](#) [55410.91750](#) [55462.19891](#)  
[R1G120-AD17-11](#) [R3G250-AM70-01](#) [R2E225-RA02-47](#) [RER225-63/18/2TDMP](#) [R4E310-AO12-14](#) [D2E146-HT65-64](#) [3612751](#) [G2D140-](#)  
[AC30-18](#) [55416.32](#) [55416.35](#)