



80×80×15 mm

San Ace 80 9GA type Low Power Consumption Fan

General Specifications

- Material Frame: Plastic (Flammability: UL 94V-0), Impeller: Plastic (Flammability: UL 94V-0)
- Expected life See the table below. (L10 life: 90% survival rate for continuous operation in free air at 60°C, rated voltage)
- Motor protection function Locked rotor burnout protection, Reverse polarity protection
For details, please refer to p. 547.
- Dielectric strength 50/60 Hz, 500 VAC, for 1 minute (between lead wire conductors and frame)
- Insulation resistance 10 MΩ or more with a 500 VDC megger (between lead wire conductors and frame)
- Sound pressure level (SPL) At 1 m away from the air inlet
- Storage temperature -30 to +70°C (Non-condensing)
- Lead wire ⊕Red ⊖Black (Sensor) Yellow (Control) Brown
(For models without PWM control function, there is no speed control wiring.)
- Mass 65 g

Specifications

The models listed below **have ribs and pulse sensors with PWM control function.**

Model no.	Rated voltage [V]	Operating voltage range [V]	PWM duty cycle* [%]	Rated current [A]	Rated input [W]	Rated speed [min ⁻¹]	Max. airflow [m ³ /min] [CFM]	Max. static pressure [Pa] [inchH ₂ O]	SPL [dB (A)]	Operating temperature [°C]	Expected life [h]
9GA0812P7G001	12	10.2 to 13.8	100	0.29	3.48	6100	1.44 50.9	84.0 0.34	41	-20 to +70	40000/60°C (70000/40°C)
9GA0812P7S001			100	0.17	2.04	5000	1.18 41.7	56.4 0.23	37		
9GA0824P7G001	24	20.4 to 27.6	100	0.13	3.12	6100	1.44 50.9	84.0 0.34	41		
9GA0824P7S001			100	0.08	1.92	5000	1.18 41.7	56.4 0.23	37		

* PWM frequency: 25 kHz. Fan does not rotate when PWM duty cycle is 0%.

The following sensor and control options are available for selection.

Differs according to the model. Refer to the table on pp. 571 to 572. **Lock sensor**

The models listed below **have ribs and pulse sensors.**

Model no.	Rated voltage [V]	Operating voltage range [V]	Rated current [A]	Rated input [W]	Rated speed [min ⁻¹]	Max. airflow [m ³ /min] [CFM]	Max. static pressure [Pa] [inchH ₂ O]	SPL [dB (A)]	Operating temperature [°C]	Expected life [h]
9GA0812H7001	12	6 to 13.2	0.09	1.08	3800	0.89 31.4	32.6 0.13	29	-20 to +70	40000/60°C (70000/40°C)
9GA0824H7001	24	12 to 26.4	0.05	1.2	3800	0.89 31.4	32.6 0.13	29		

The following sensor and control options are available for selection.

Available for all models. **Lock sensor**

Differs according to the model. Refer to the table on p. 571. **Without sensor**

Airflow - Static Pressure Characteristics / PWM Duty - Speed Characteristics Example

9GA0812P7G001 With pulse sensor with PWM control function

PWM duty cycle

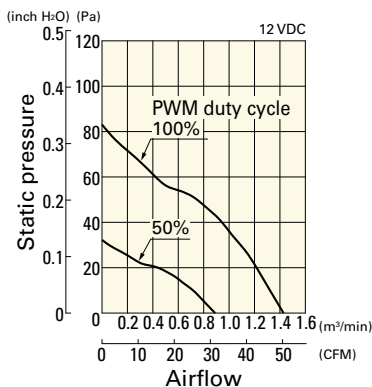

Operating voltage range

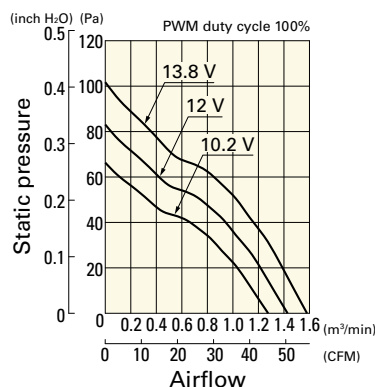

PWM duty - Speed characteristics example

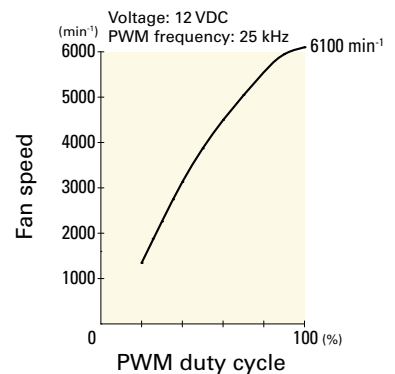

Airflow - Static Pressure Characteristics / PWM Duty - Speed Characteristics Example

9GA0812P7S001 With pulse sensor with PWM control function

PWM duty cycle

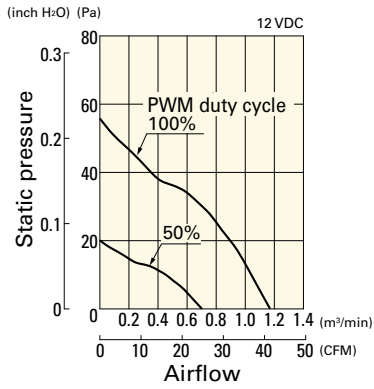

Operating voltage range

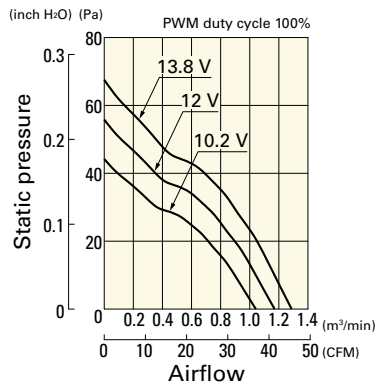

PWM duty - Speed characteristics example

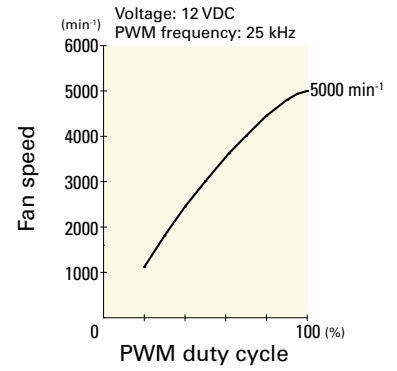

9GA0824P7G001 With pulse sensor with PWM control function

PWM duty cycle

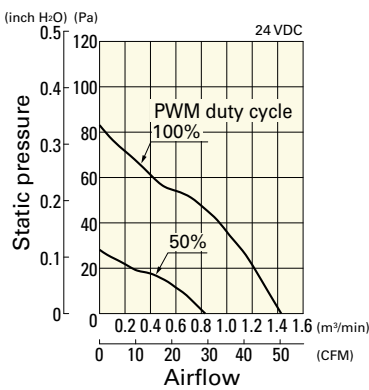

Operating voltage range

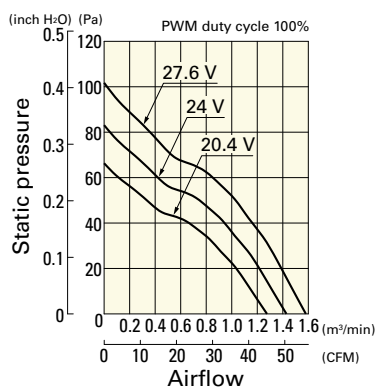

PWM duty - Speed characteristics example

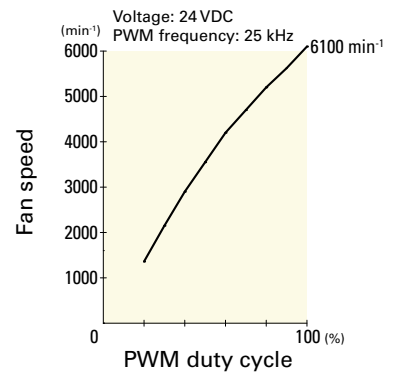

9GA0824P7S001 With pulse sensor with PWM control function

PWM duty cycle

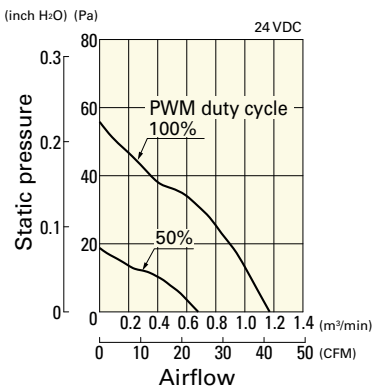

Operating voltage range

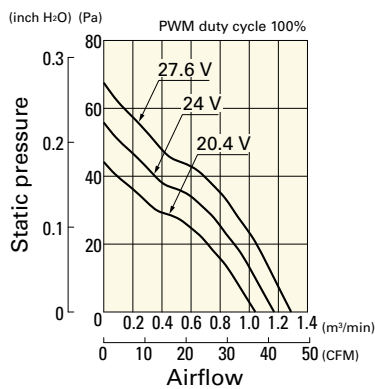

PWM duty - Speed characteristics example

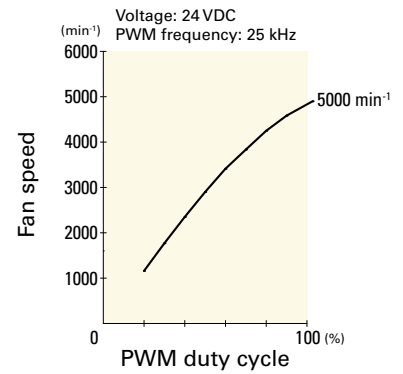

9GA0812H7001 With pulse sensor

Operating voltage range

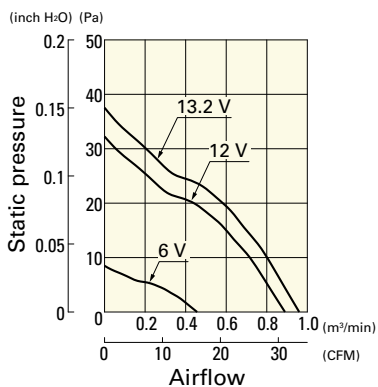

9GA0824H7001 With pulse sensor

Operating voltage range

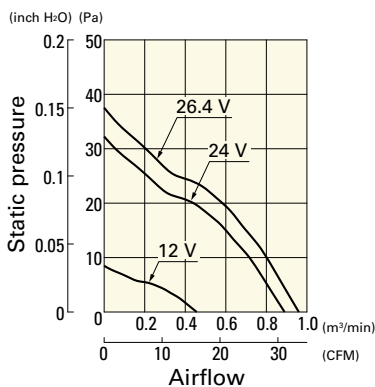

Dimensions (unit: mm) (With pulse sensor with PWM control function)

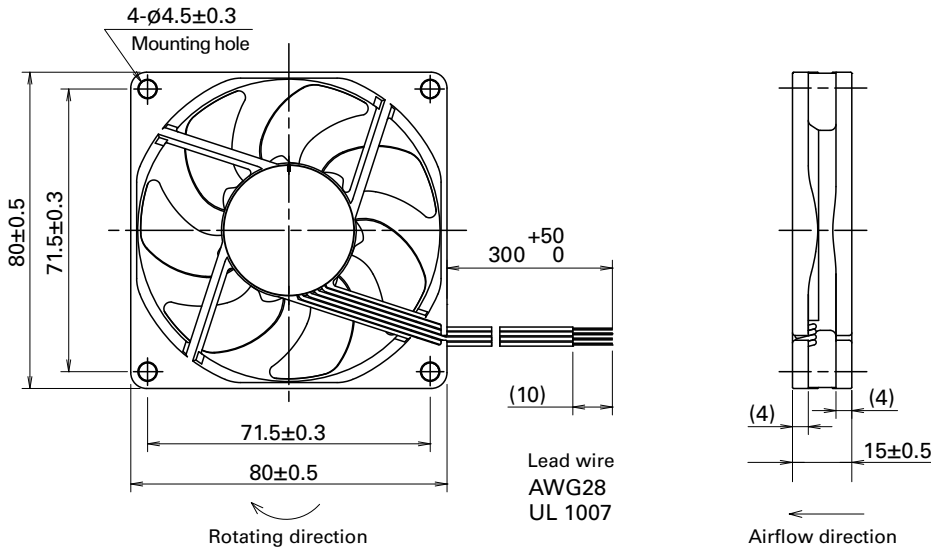

Reference Dimensions of Mounting Holes and Vent Opening (unit: mm)

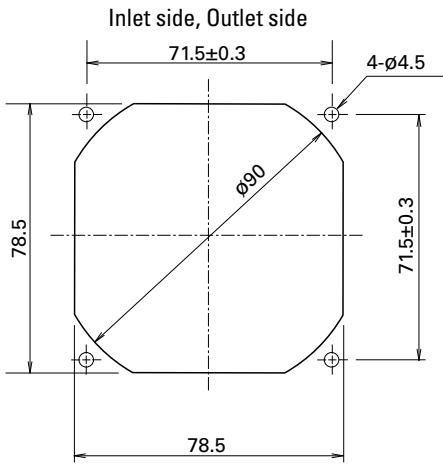

Options

Finger guards

page: p. 532

Model no.: 109-049E, 109-049H, 109-049C

Resin finger guards

page: p. 539

Model no.: 109-1002G

Resin filter kits

page: p. 540

Model no.: 109-1002F13 (13PPI), 109-1002F20 (20PPI),
109-1002F30 (30PPI), 109-1002F40 (40PPI)

X-ON Electronics

Largest Supplier of Electrical and Electronic Components

Click to view similar products for [DC Fans](#) category:

Click to view products by [Sanyo Denki](#) manufacturer:

Other Similar products are found below :

[F1238H24B-FHR](#) [F1238X24B1-FSR-TTL](#) [PMD1204PBB1-A \(2\).GN](#) [AUB0612L](#) [F6025X12B1-RHR](#) [G4020H05B2-RSR-EM](#) [4318/12T](#)
[AUB0912H-F00](#) [3412N/2ME](#) [W2G110-AM39-01](#) [USTF501005HW](#) [8412GLV](#) [8412NGL-12](#) [6448-384](#) [3258JH](#) [4114N/17-251](#) [4412F/2D](#)
[OD127AP-28HTB](#) [424JMU](#) [3110KL-05W-B50-G00](#) [1608KL-04W-B29-L00](#) [EF40101BX-1000U-G99](#) [4414/2HH](#) [512F/2P-549](#) [4112](#)
[N/12GL-175](#) [9GA0924L4021](#) [9GA0924M4021](#) [9GA0924M4011](#) [9GA0912M4D011](#) [9GA0924W4D01](#) [9GA0912F4021](#) [9GA0912H4D011](#)
[9GA0824L20021](#) [9GA0824L20011](#) [9GA0812A2002](#) [9GA0812B2D001](#) [9GA0812L20021](#) [9WP1248M1021](#) [9GA0812A2D001](#)
[9GA0824L2D001](#) [9GA0924W4D011](#) [9GA0912W402](#) [9GA0912M402](#) [9GA0824B2D001](#) [9GA0824A20021](#) [9GA0912W4021](#)
[9GA0924W402](#) [9GA0812L2D0011](#) [9GA0812A20021](#) [9GA0824L2001](#)