



80x80x38 mm

San Ace 80 9GA type Low Power Consumption Fan

General Specifications

- Material Frame: Plastic (Flammability: UL 94V-0), Impeller: Plastic (Flammability: UL 94V-0)
- Expected life See the table below. (L10 life: 90% survival rate for continuous operation in free air at 60°C, rated voltage)
- Motor protection function Locked rotor burnout protection, Reverse polarity protection
For details, please refer to p. 547.
- Dielectric strength 50/60 Hz, 500 VAC, for 1 minute (between lead wire conductors and frame)
- Insulation resistance 10 MΩ or more with a 500 VDC megger (between lead wire conductors and frame)
- Sound pressure level (SPL) At 1 m away from the air inlet
- Storage temperature -30 to +70°C (Non-condensing)
- Lead wire ⊕Red ⊖Black Sensor Yellow Control Brown
- Mass 160 g

Specifications

The models listed below **have ribs and pulse sensors with PWM control function**. For models without ribs, append "1" to the end of model numbers.

Model no.	Rated voltage [V]	Operating voltage range [V]	PWM duty cycle* [%]	Rated current [A]	Rated input [W]	Rated speed [min ⁻¹]	Max. airflow [m ³ /min] [CFM]	Max. static pressure [Pa] [inchH ₂ O]	SPL [dB (A)]	Operating temperature [°C]	Expected life [h]		
9GA0812P1G61	12	10.8 to 13.2	100	1.2	14.4	10500	2.85 100.6	480 1.93	60	-20 to +70	40000/60°C (70000/40°C)		
			0	0.04	0.48	2000	0.51 18.0	28.7 0.11	21				
9GA0812P1S61			100	0.94	11.28	9550	2.6 91.8	480 1.93	59				
			0	0.1	1.2	2900	0.74 26.1	60 0.24	27				
9GA0812P1H61			100	0.6	7.2	8250	2.25 79.4	380 1.53	55				
			0	0.08	0.96	2500	0.64 22.6	45 0.18	24				
9GA0824P1S61	24	20.4 to 27.6	100	0.47	11.28	9550	2.6 91.8	480 1.93	59				
			0	0.06	1.44	2900	0.74 26.1	60 0.24	27				
9GA0824P1H61			100	0.3	7.2	8250	2.25 79.4	380 1.53	55				
			0	0.05	1.2	2500	0.64 22.6	45 0.18	24				
9GA0848P1S61			48	40.8 to 55.2	100	0.25	12	9550	2.6 91.8			480 1.93	59
					0	0.04	1.92	2900	0.74 26.1			60 0.24	27

* PWM frequency: 25 kHz

The following sensor and control options are available for selection.

Differs according to the model. Refer to the table on pp. 571 to 572. Without sensor Pulse sensor Lock sensor

Airflow - Static Pressure Characteristics / PWM Duty - Speed Characteristics Example

9GA0812P1G61 With pulse sensor with PWM control function

PWM duty cycle

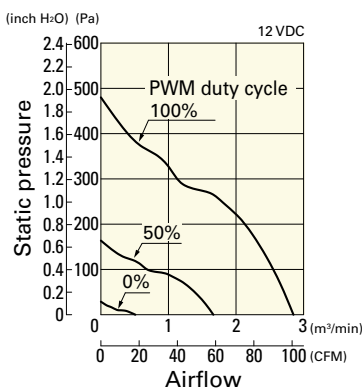

Operating voltage range

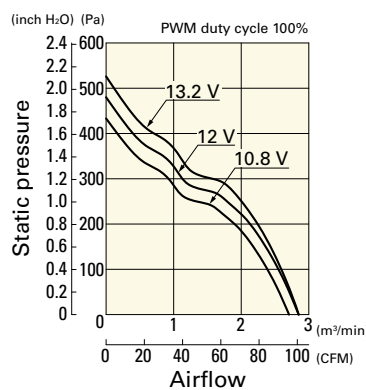

PWM duty - Speed characteristics example

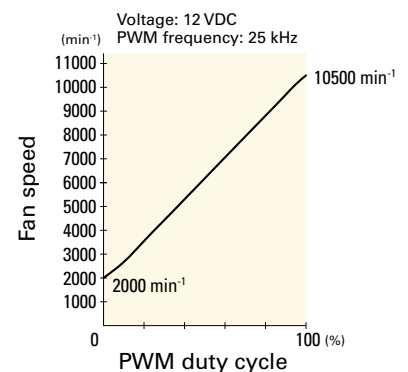

Airflow - Static Pressure Characteristics / PWM Duty - Speed Characteristics Example

9GA0812P1S61 With pulse sensor with PWM control function

PWM duty cycle

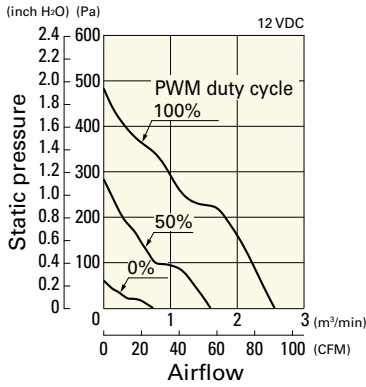

Operating voltage range

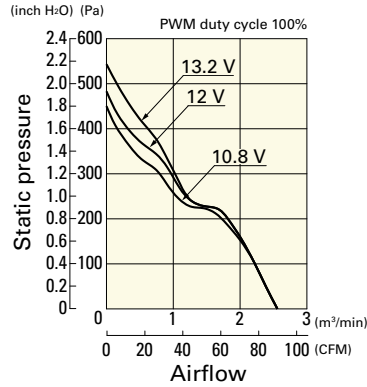

PWM duty - Speed characteristics example

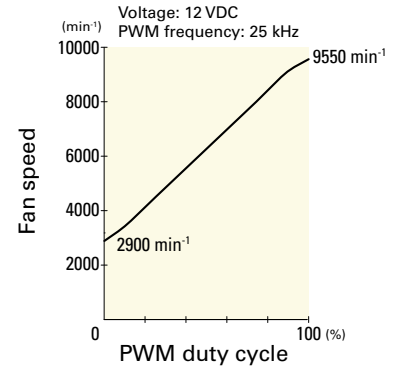

9GA0812P1H61 With pulse sensor with PWM control function

PWM duty cycle

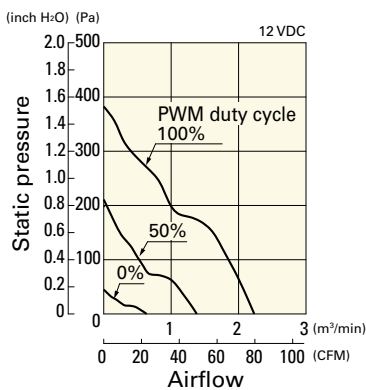

Operating voltage range

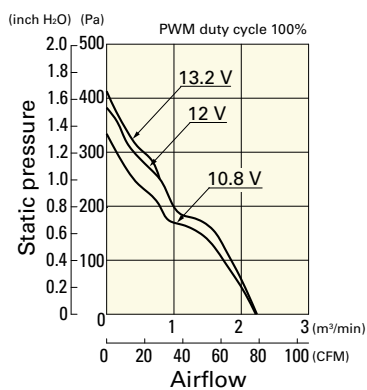

PWM duty - Speed characteristics example

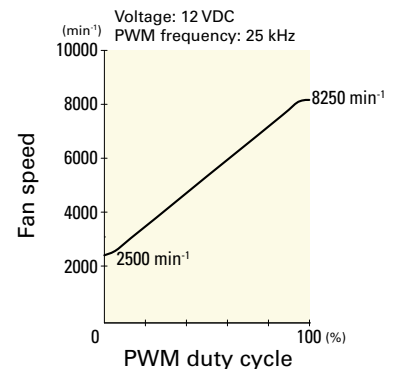

9GA0824P1S61 With pulse sensor with PWM control function

PWM duty cycle

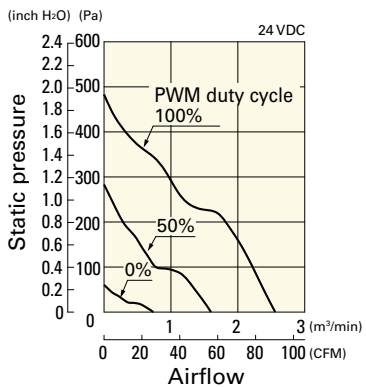

Operating voltage range

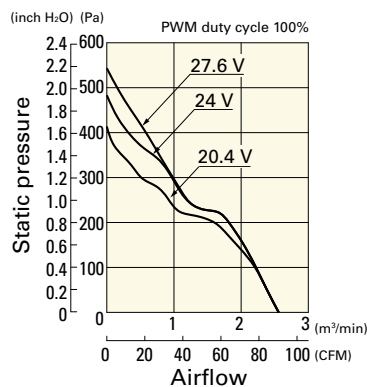

PWM duty - Speed characteristics example

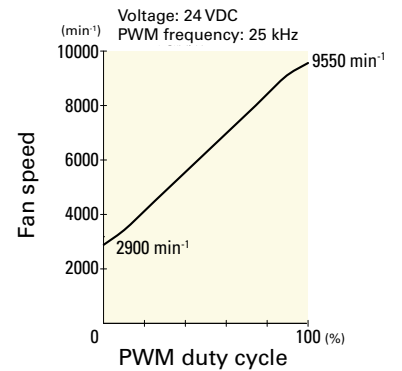

9GA0824P1H61 With pulse sensor with PWM control function

PWM duty cycle

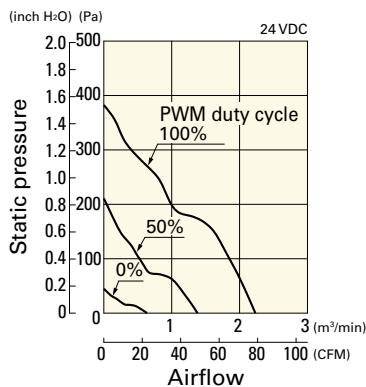

Operating voltage range

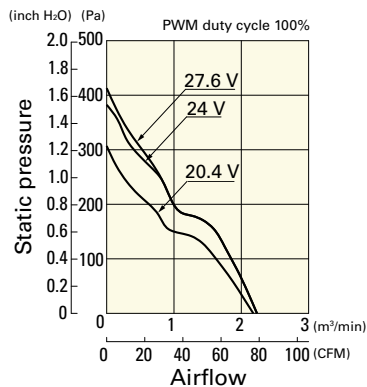

PWM duty - Speed characteristics example

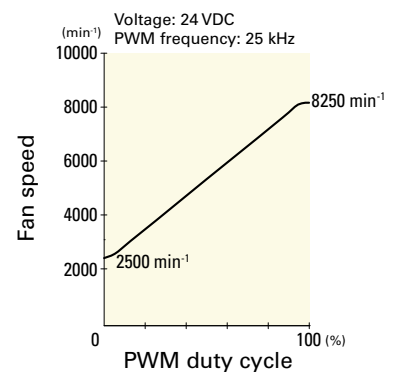

Airflow - Static Pressure Characteristics / PWM Duty - Speed Characteristics Example

9GA0848P1S61 With pulse sensor with PWM control function

PWM duty cycle

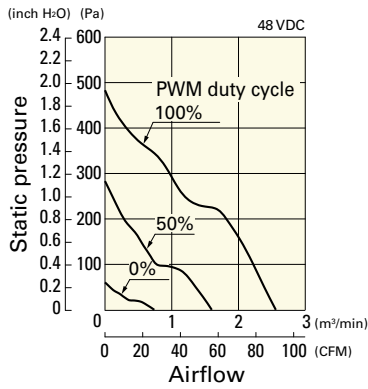

Operating voltage range

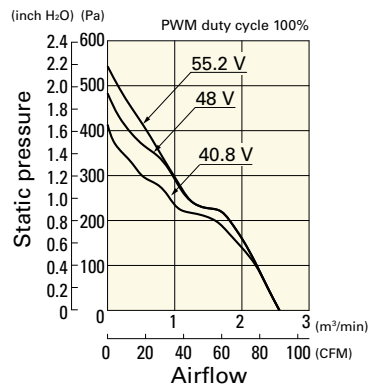

PWM duty - Speed characteristics example

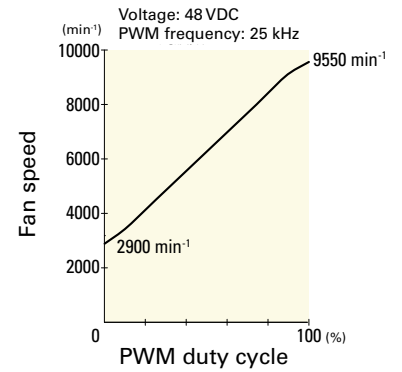

Dimensions (unit: mm) (With ribs)

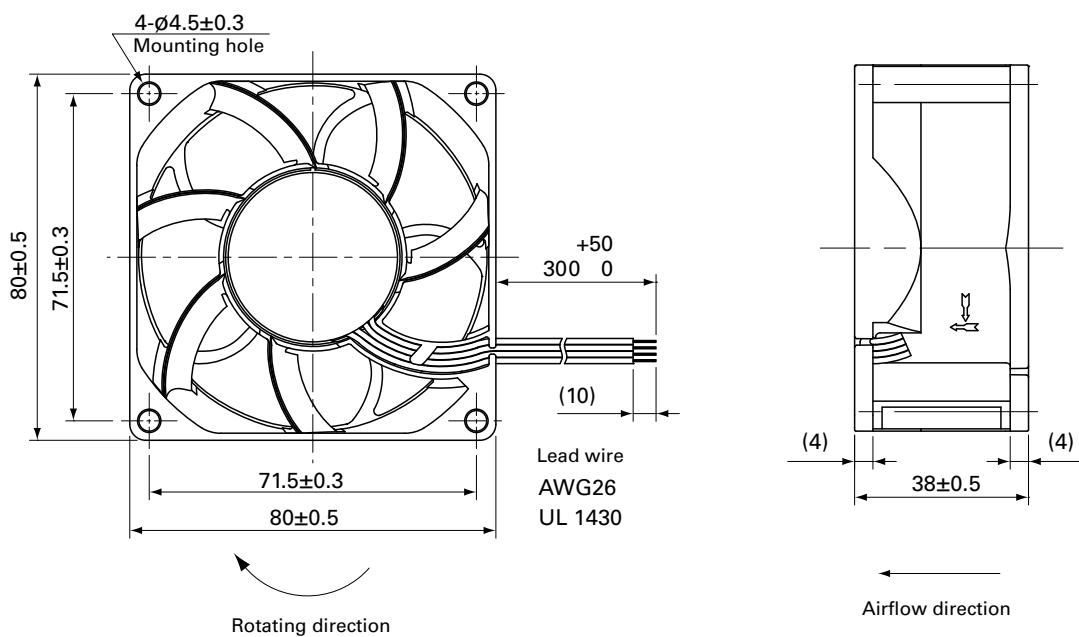

Reference Dimensions of Mounting Holes and Vent Opening (unit: mm)

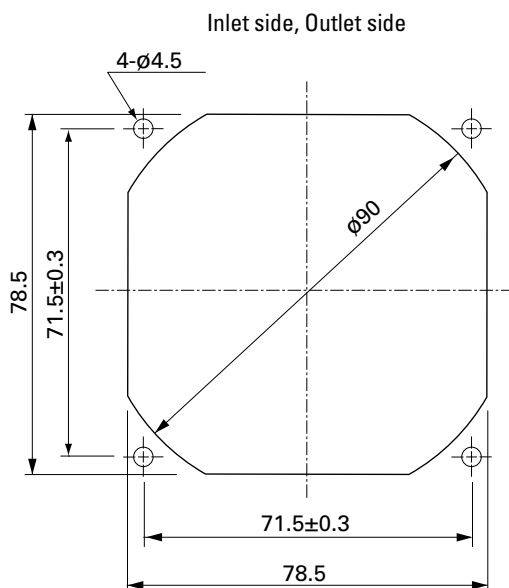

Options

Finger guards

page: p. 532

Model no.: 109-049E, 109-049H, 109-049C

Resin finger guards

page: p. 539

Model no.: 109-1002G

Resin filter kits

page: p. 540

Model no.: 109-1002F13 (13PPI), 109-1002F20 (20PPI),
109-1002F30 (30PPI), 109-1002F40 (40PPI)

X-ON Electronics

Largest Supplier of Electrical and Electronic Components

Click to view similar products for [DC Fans](#) category:

Click to view products by [Sanyo Denki](#) manufacturer:

Other Similar products are found below :

[614R](#) [AUB0612L](#) [AFB0948HH-S687](#) [G2E085-AA05-10](#) [4318/12T](#) [AUB0912H-F00](#) [3412N/2ME](#) [W2G110-AM39-01](#) [8412GLV](#) [8412NGL-12](#) [6448-384](#) [4114N/17-251](#) [4318/2R](#) [4412F/2D](#) [424JMU](#) [4414/2HH](#) [4112 N/12GL-175](#) [9GA0912F402](#) [9GA0812B20011](#)
[AFB0824SHBAV1](#) [DV5214/2NP-230](#) [9GA0912H4021](#) [THC1548MGDJJ](#) [9GA0812B2001](#) [GFB1224SHG](#) [8500NU](#) [9WG1212E101-E](#)
[3241.124](#) [DC1203812W2B-2T0](#) [MF40060V1-1000U-G99](#) [DC0401012V2B-3T0](#) [ASFP14391](#) [ASFP64371](#) [ASFP64391](#) [ASFP84391](#)
[ASFP92391](#) [9A0612G402](#) [AD5012HB-C71](#) [AD5012MB-C71](#) [ASFP84372](#) [ASFP64372](#) [31100-000440-RS](#) [026758A](#) [514F](#) [MEC0381V1-000U-G99](#) [4292](#) [MF40101V2-1000U-A99](#) [MF60152V1-1000U-G99](#) [3610KL-04W-B50-D00](#) [109P0412K3023](#)