

# 92x92x25 mm

## San Ace 92 9GA type Low Power Consumption Fan



### General Specifications

- Material ..... Frame: Plastic (Flammability: UL 94V-0), Impeller: Plastic (Flammability: UL 94V-0)
- Expected life ..... See the table below. (L10 life: 90% survival rate for continuous operation in free air at 60°C, rated voltage)
- Motor protection function ..... Locked rotor burnout protection, Reverse polarity protection  
For details, please refer to p. 547.
- Dielectric strength ..... 50/60 Hz, 500 VAC, for 1 minute (between lead wire conductors and frame)
- Insulation resistance ..... 10 MΩ or more with a 500 VDC megger (between lead wire conductors and frame)
- Sound pressure level (SPL) ..... At 1 m away from the air inlet
- Storage temperature ..... -30 to +70°C (Non-condensing)
- Lead wire ..... ⊕Red ⊖Black (Sensor) Yellow (Control) Brown  
(For models without PWM control function, there is no speed control wiring.)
- Mass ..... 125 g

### Specifications

The models listed below **have ribs and pulse sensors with PWM control function**. For models without ribs, append "1" to the end of model numbers.

Model no.	Rated voltage [V]	Operating voltage range [V]	PWM duty cycle* [%]	Rated current [A]	Rated input [W]	Rated speed [min <sup>-1</sup> ]	Max. airflow [m <sup>3</sup> /min] [CFM]		Max. static pressure [Pa] [inchH <sub>2</sub> O]		SPL [dB (A)]	Operating temperature [°C]	Expected life [h]	
9GA0912P4J03	12	10.2 to 13.8	100	0.39	4.68	5000	2.2	77.7	105	0.42	43	-20 to +70	60000/60°C	
			0	0.06	0.72	1500	0.65	23.3	9.4	0.04	14			
9GA0912P4G03			100	0.28	3.36	4400	1.93	68.2	81	0.33	39			
			0	0.06	0.72	1500	0.65	23.3	9.4	0.04	14			
9GA0912P4S03			100	0.2	2.4	3800	1.67	59.0	60.6	0.24	35			
			0	0.06	0.72	1500	0.65	23.3	9.4	0.04	14			
9GA0924P4J03		24	20.4 to 27.6	100	0.2	4.8	5000	2.2	77.7	105	0.42			43
				0	0.04	0.96	1500	0.65	23.3	9.4	0.04			14
9GA0924P4G03				100	0.15	3.6	4400	1.93	68.2	81	0.33			39
				0	0.04	0.96	1500	0.65	23.3	9.4	0.04			14
9GA0924P4S03				100	0.12	2.88	3800	1.67	59.0	60.6	0.24			35
				0	0.04	0.96	1500	0.65	23.3	9.4	0.04			14

\* PWM frequency: 25 kHz

The following sensor and control options are available for selection.

Available for all models. **Without sensor** **Pulse sensor**

Differs according to the model. Refer to the table on p. 572. **Lock sensor**

The models listed below **have ribs and pulse sensors**. For models without ribs, append "1" to the end of model numbers.

Model no.	Rated voltage [V]	Operating voltage range [V]	Rated current [A]	Rated input [W]	Rated speed [min <sup>-1</sup> ]	Max. airflow [m <sup>3</sup> /min] [CFM]		Max. static pressure [Pa] [inchH <sub>2</sub> O]		SPL [dB (A)]	Operating temperature [°C]	Expected life [h]	
9GA0912H401	12	10.2 to 13.8	0.19	2.28	3300	1.45	51.2	45.6	0.18	31	-20 to +70	60000/60°C	
9GA0912F401			0.14	1.68	2800	1.23	43.5	32.9	0.13	28			
9GA0912M401			0.11	1.32	2400	1.05	37.1	24	0.096	24			
9GA0912L401			0.09	1.08	2000	0.87	30.7	16.7	0.067	21			
9GA0912W401			0.19	2.28	3300	1.45	51.2	45.6	0.18	31			
9GA0924H401			24	20.4 to 27.6	0.09	2.16	3300	1.45	51.2	45.6			0.18
		16 to 27.6		0.08	1.92	2800	1.23	43.5	32.9	0.13			28
		14 to 27.6		0.05	1.2	2400	1.05	37.1	24	0.096			24
				0.03	0.72	2000	0.87	30.7	16.7	0.067			21
		9GA0924L401		0.03	0.72	2000	0.87	30.7	16.7	0.067			21
		9GA0924W401		0.09	2.16	3300	1.45	51.2	45.6	0.18			31

The following sensor and control options are available for selection.

Available for all models. **Without sensor** **Lock sensor**

# Airflow - Static Pressure Characteristics / PWM Duty - Speed Characteristics Example

## 9GA0912P4J03 With pulse sensor with PWM control function

PWM duty cycle

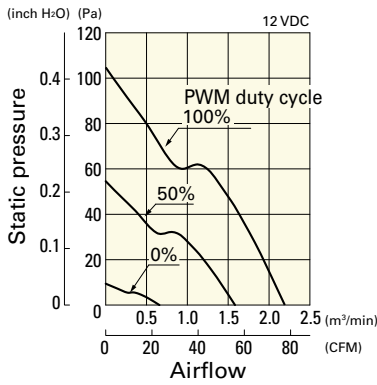

Operating voltage range

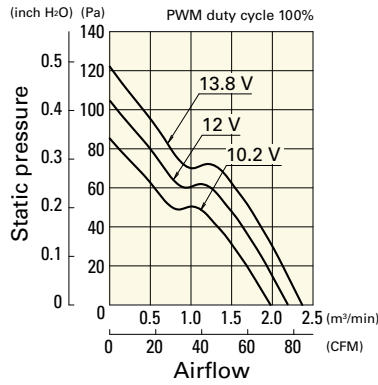

PWM duty - Speed characteristics example

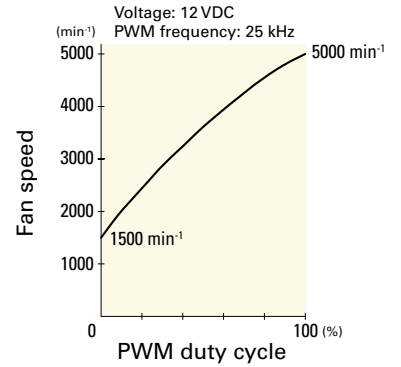

## 9GA0912P4G03 With pulse sensor with PWM control function

PWM duty cycle

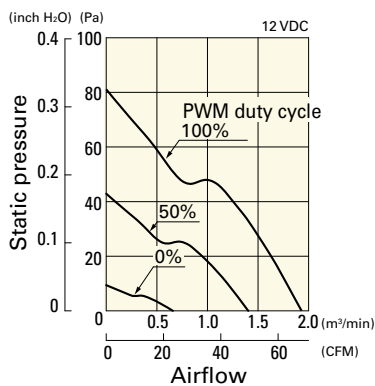

Operating voltage range

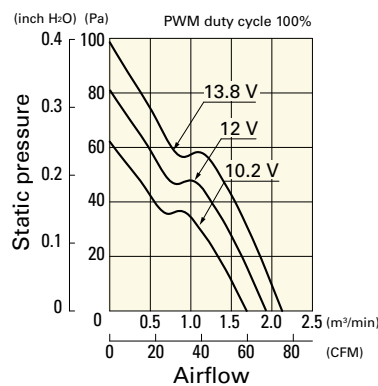

PWM duty - Speed characteristics example

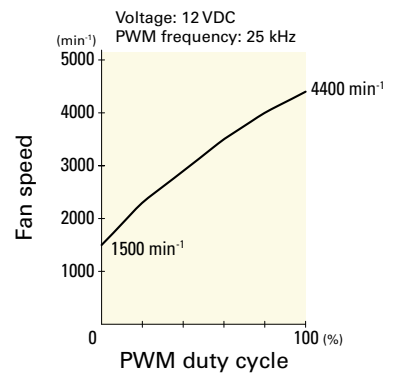

## 9GA0912P4S03 With pulse sensor with PWM control function

PWM duty cycle

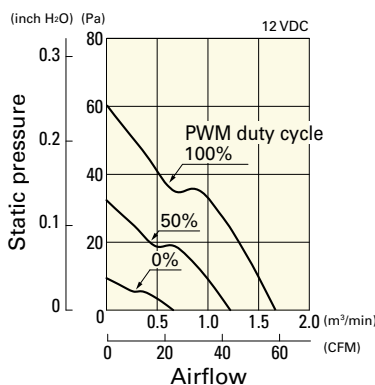

Operating voltage range

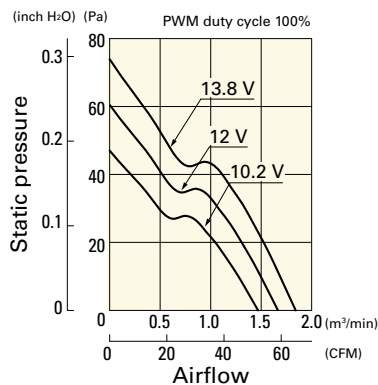

PWM duty - Speed characteristics example

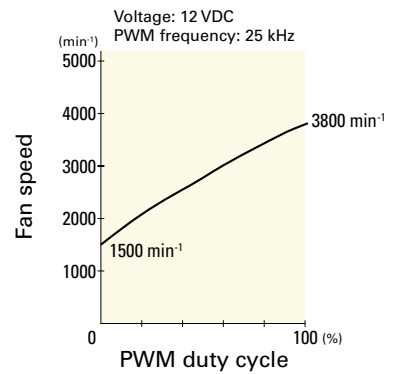

## 9GA0924P4J03 With pulse sensor with PWM control function

PWM duty cycle

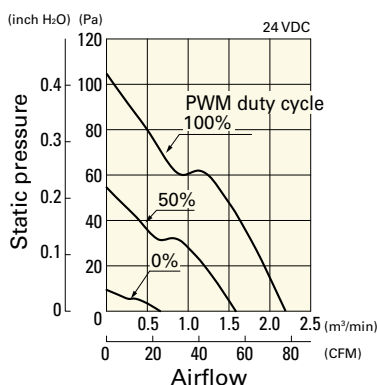

Operating voltage range

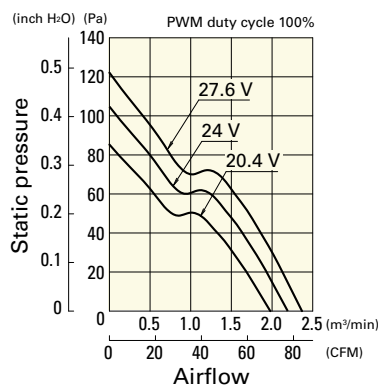

PWM duty - Speed characteristics example

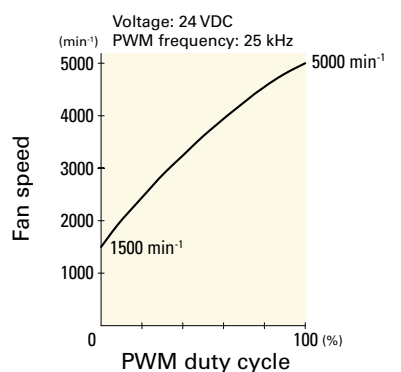

# Airflow - Static Pressure Characteristics / PWM Duty - Speed Characteristics Example

**9GA0924P4G03** With pulse sensor with PWM control function

PWM duty cycle

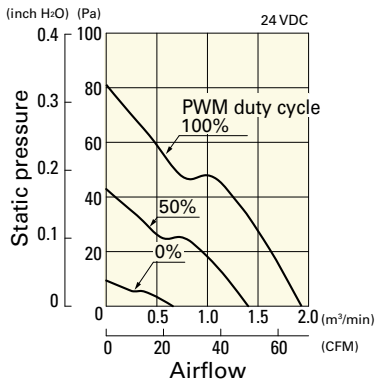

Operating voltage range

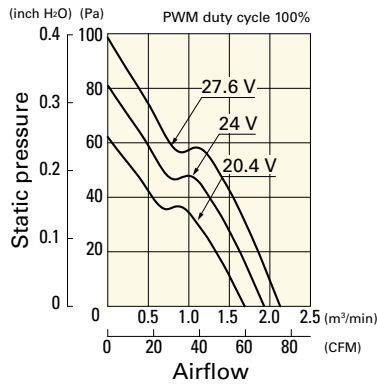

PWM duty - Speed characteristics example

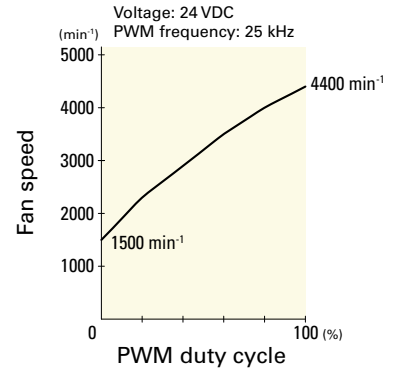

**9GA0924P4S03** With pulse sensor with PWM control function

PWM duty cycle

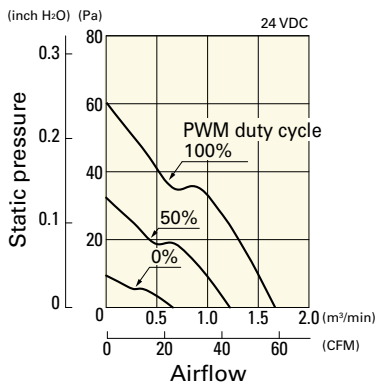

Operating voltage range

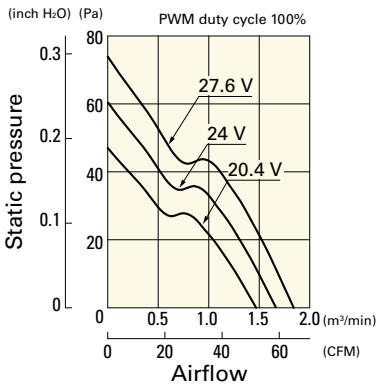

PWM duty - Speed characteristics example

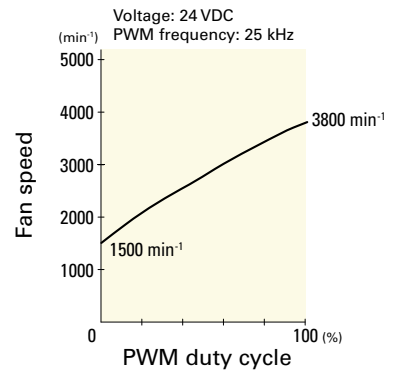

**9GA0912H401** With pulse sensor

Operating voltage range

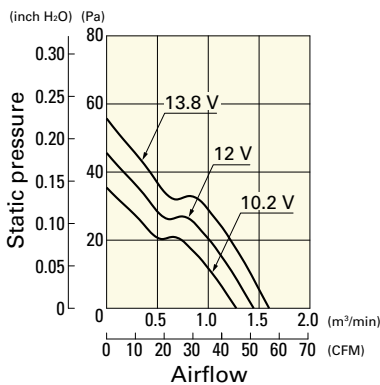

**9GA0912F401** With pulse sensor

Operating voltage range

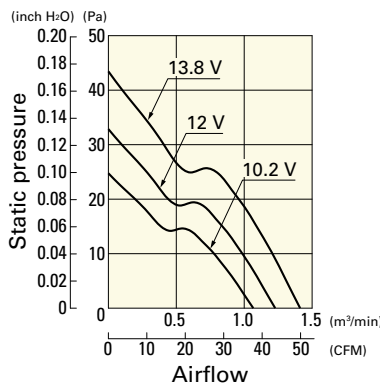

**9GA0912M401** With pulse sensor

Operating voltage range

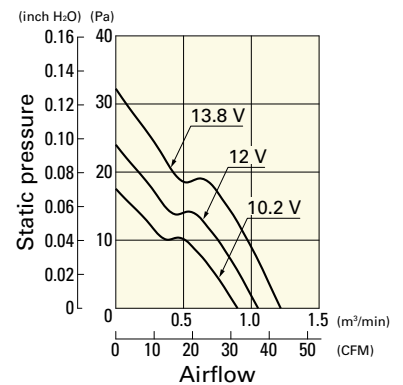

**9GA0912L401** With pulse sensor

Operating voltage range

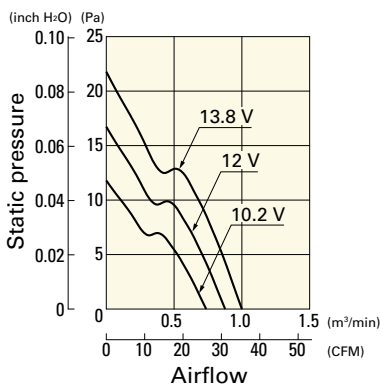

**9GA0912W401** With pulse sensor

Operating voltage range

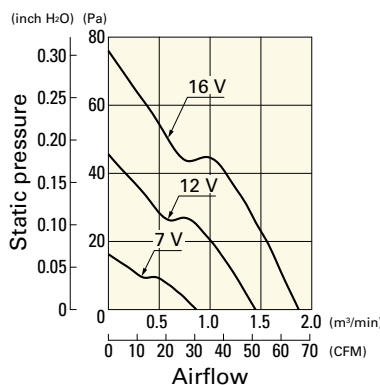

**9GA0924H401** With pulse sensor

Operating voltage range

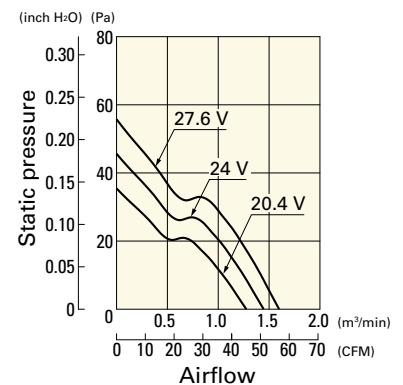

**Airflow - Static Pressure Characteristics**

**9GA0924F401** With pulse sensor

Operating voltage range

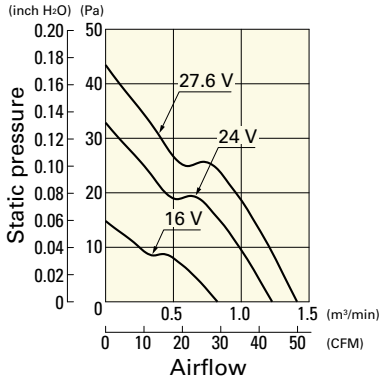

**9GA0924M401** With pulse sensor

Operating voltage range

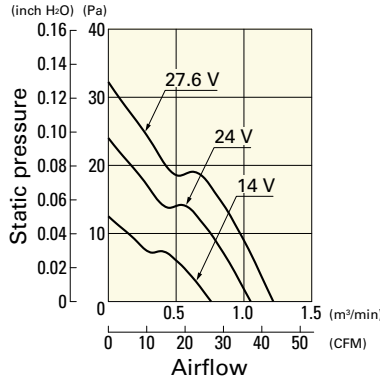

**9GA0924L401** With pulse sensor

Operating voltage range

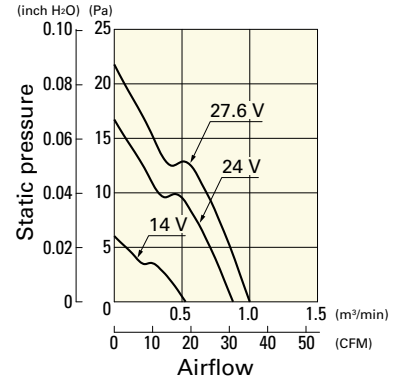

**9GA0924W401** With pulse sensor

Operating voltage range

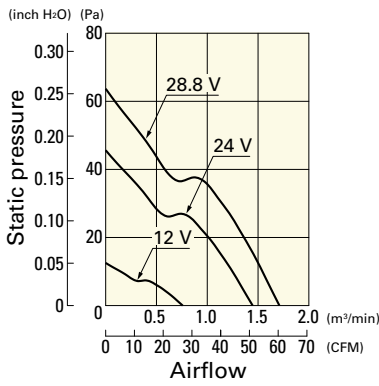

**Dimensions (unit: mm)** (With ribs)

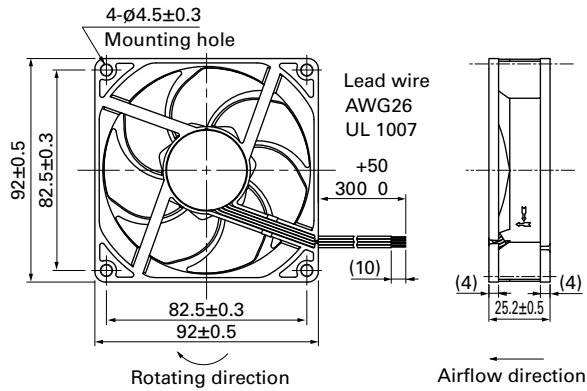

**Reference Dimensions of Mounting Holes and Vent Opening (unit: mm)**

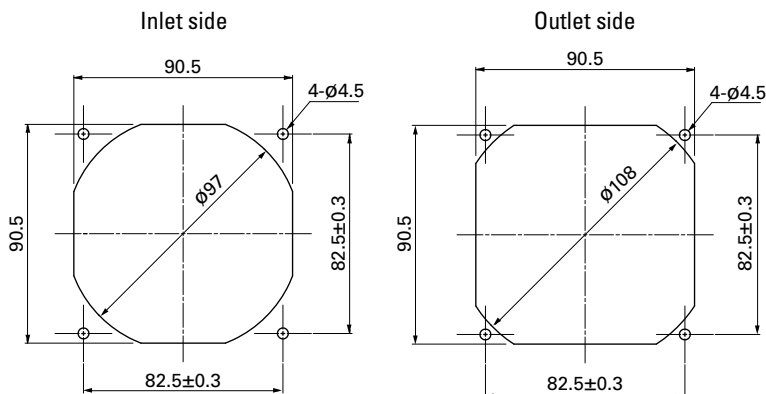

## Options

---

### Finger guards

page: p. 532

Model no.: 109-099E, 109-099H, 109-099C

### Resin finger guards

page: p. 539

Model no.: 109-1001G

### Resin filter kits

page: p. 540

Model no.: 109-1001F13 (13PPI), 109-1001F20 (20PPI),  
109-1001F30 (30PPI), 109-1001F40 (40PPI)

## X-ON Electronics

Largest Supplier of Electrical and Electronic Components

*Click to view similar products for [DC Fans](#) category:*

*Click to view products by [Sanyo Denki](#) manufacturer:*

Other Similar products are found below :

[614R](#) [AUB0612L](#) [AFB0948HH-S687](#) [G2E085-AA05-10](#) [4318/12T](#) [AUB0912H-F00](#) [3412N/2ME](#) [W2G110-AM39-01](#) [8412GLV](#) [8412NGL-12](#) [6448-384](#) [4114N/17-251](#) [4318/2R](#) [4412F/2D](#) [424JMU](#) [4414/2HH](#) [4112 N/12GL-175](#) [9GA0912F402](#) [9GA0812B20011](#)  
[AFB0824SHBAV1](#) [DV5214/2NP-230](#) [9GA0912H4021](#) [THC1548MGDJJ](#) [9GA0812B2001](#) [GFB1224SHG](#) [8500NU](#) [9WG1212E101-E](#)  
[3241.124](#) [DC0401012V2B-3T0](#) [ASFP14391](#) [ASFP64371](#) [ASFP64391](#) [ASFP84391](#) [ASFP92391](#) [9A0612G402](#) [AD5012HB-C71](#)  
[AD5012MB-C71](#) [ASFP84372](#) [ASFP64372](#) [31100-000440-RS](#) [ASFP14372](#) [ASFP16371](#) [ASFP16372](#) [ASFP40770](#) [ASFP42770](#) [ASFP44770](#)  
[ASFP64392](#) [ASFP82392](#) [ASFP84392](#) [ASFP92371](#)