



120×120×38 mm

San Ace 120L 9GL type

General Specifications

- Material Frame: Aluminum, Impeller: Plastic (Flammability: UL 94V-1)
- Expected life See the table below. (L10 life: 90% survival rate for continuous operation in free air at 60°C, rated voltage)
- Motor protection function Locked rotor burnout protection, Reverse polarity protection
For details, please refer to p. 547.
- Dielectric strength 50/60 Hz, 500 VAC, for 1 minute (between lead wire conductors and frame)
- Insulation resistance 10 MΩ or more with a 500 VDC megger (between lead wire conductors and frame)
- Sound pressure level (SPL) At 1 m away from the air inlet
- Storage temperature -30 to +70°C (Non-condensing)
- Lead wire ⊕Red ⊖Black or Blue (Sensor) Yellow
- Mass 370 g

Specifications

The models listed below **have pulse sensors**.

Model no.	Rated voltage [V]	Operating voltage range [V]	Rated current [A]	Rated input [W]	Rated speed [min ⁻¹]	Max. airflow [m ³ /min] [CFM]	Max. static pressure [Pa] [inchH ₂ O]	SPL [dB (A)]	Operating temperature [°C]	Expected life [h]	
9GL1212G101	12	10.2 to 13.8	0.98	11.8	3600	3.88 137	135 0.542	49	-20 to +70	80000/60°C	
9GL1212E101			0.61	7.32	3100	3.34 118	100 0.402	46			
9GL1212H101		7 to 13.8	0.38	4.56	2600	2.8 99	70.4 0.283	39			
9GL1212F101			0.28	3.36	2280	2.45 87	54.2 0.218	36			
9GL1212M101			0.21	2.52	1950	2.1 74	39.6 0.159	32			
9GL1224G101	24	20.4 to 27.6	0.5	12.0	3600	3.88 137	135 0.542	49		-20 to +70	80000/60°C
9GL1224E101			0.34	8.16	3100	3.34 118	100 0.402	46			
9GL1224H101		14 to 27.6	0.22	5.28	2600	2.8 99	70.4 0.283	39			
9GL1224F101			0.16	3.84	2280	2.45 87	54.2 0.218	36			
9GL1224M101			0.11	2.64	1950	2.1 74	39.6 0.159	32			
9GL1248G101	48	40.8 to 55.2	0.25	12.0	3600	3.88 137	135 0.542	49	-20 to +70		80000/60°C
9GL1248E101			0.17	8.16	3100	3.34 118	100 0.402	46			
9GL1248H101			0.11	5.28	2600	2.8 99	70.4 0.283	39			
9GL1248F101			0.09	4.32	2280	2.45 87	54.2 0.218	36			
9GL1248M101			0.07	3.36	1950	2.1 74	39.6 0.159	32			

The following sensor and control options are available for selection.

Available for all models. **Without sensor** **Lock sensor**

Airflow - Static Pressure Characteristics

9GL1212G101 With pulse sensor

Operating voltage range

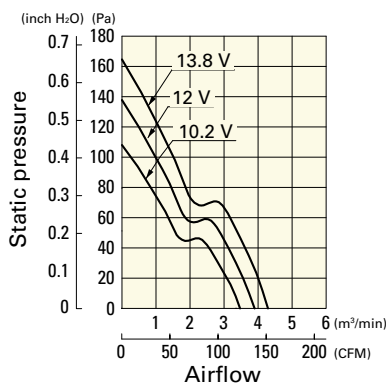

9GL1212E101 With pulse sensor

Operating voltage range

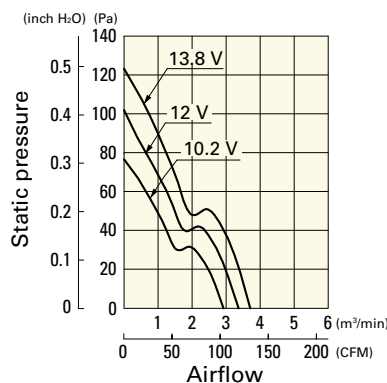

9GL1212H101 With pulse sensor

Operating voltage range

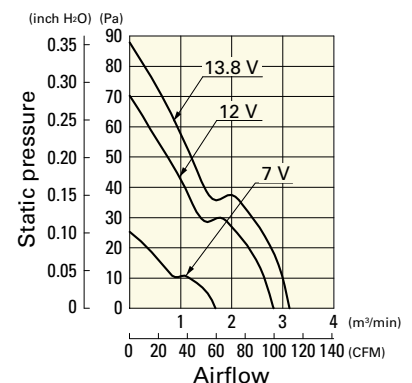

Airflow - Static Pressure Characteristics

9GL1212F101 With pulse sensor

Operating voltage range

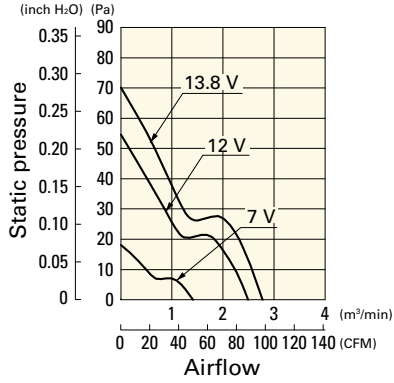

9GL1212M101 With pulse sensor

Operating voltage range

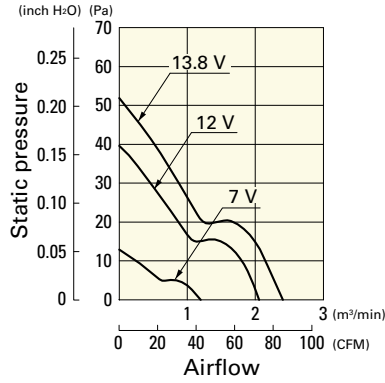

9GL1224G101 With pulse sensor

Operating voltage range

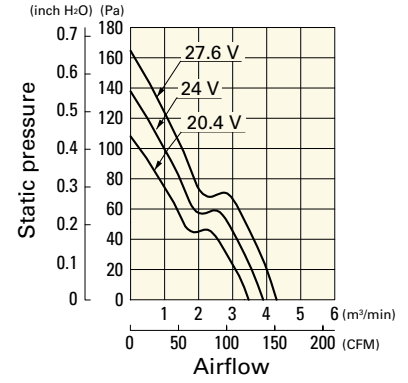

9GL1224E101 With pulse sensor

Operating voltage range

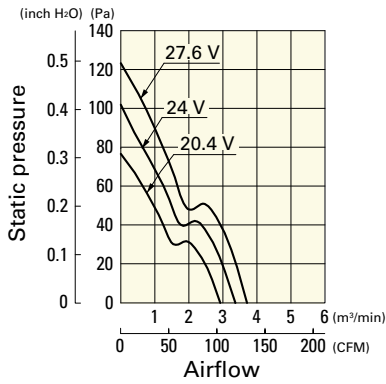

9GL1224H101 With pulse sensor

Operating voltage range

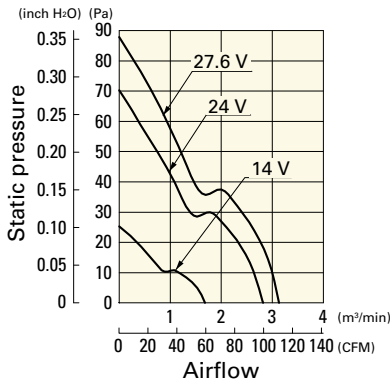

9GL1224F101 With pulse sensor

Operating voltage range

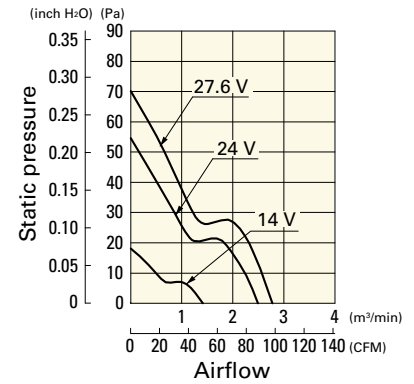

9GL1224M101 With pulse sensor

Operating voltage range

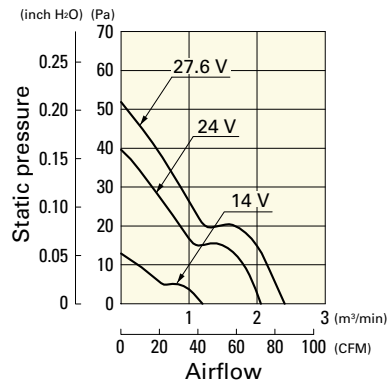

9GL1248G101 With pulse sensor

Operating voltage range

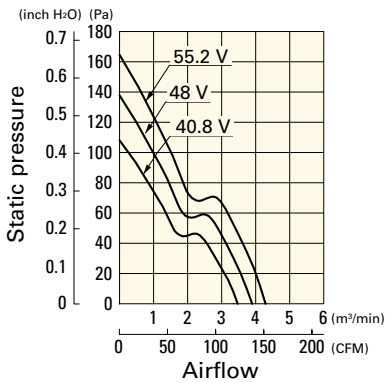

9GL1248E101 With pulse sensor

Operating voltage range

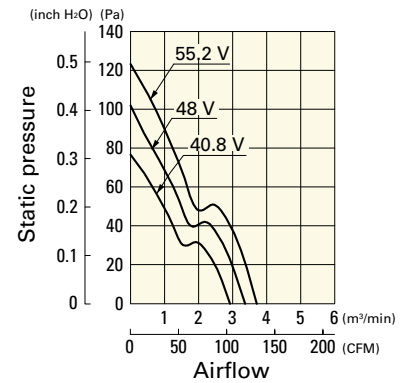

9GL1248H101 With pulse sensor

Operating voltage range

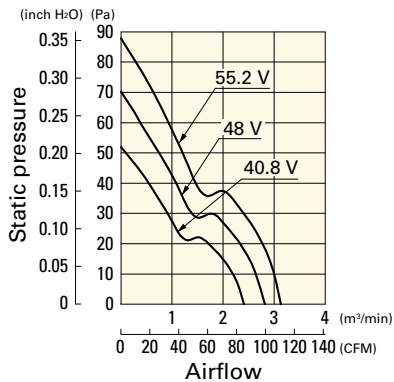

9GL1248F101 With pulse sensor

Operating voltage range

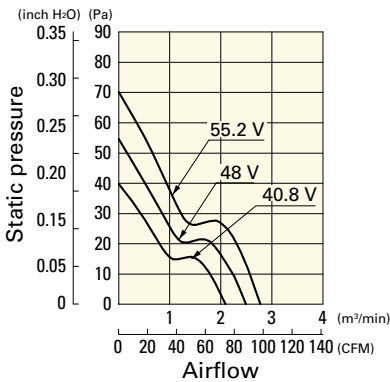

9GL1248M101 With pulse sensor

Operating voltage range

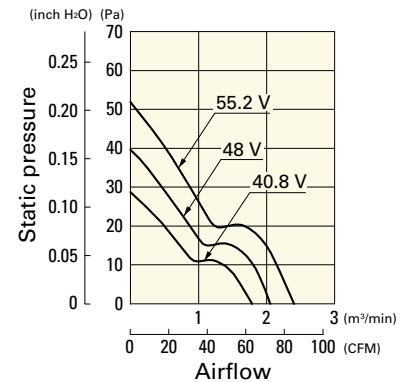

Dimensions (unit: mm)

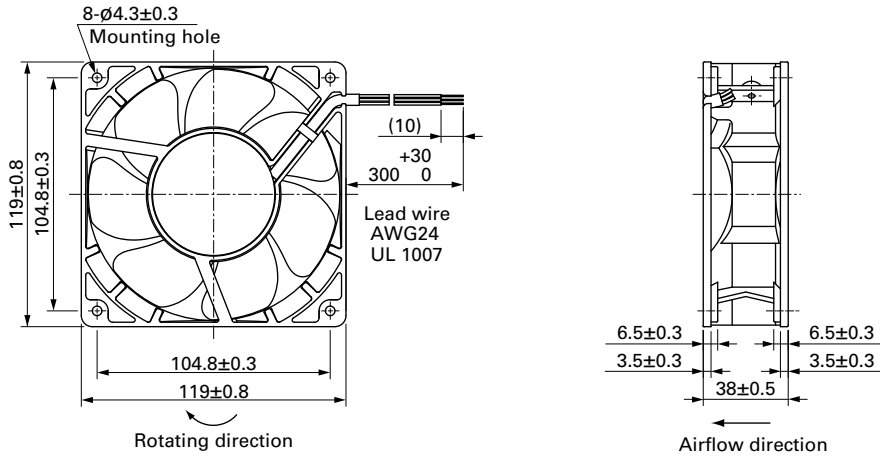

Reference Dimensions of Mounting Holes and Vent Opening (unit: mm)

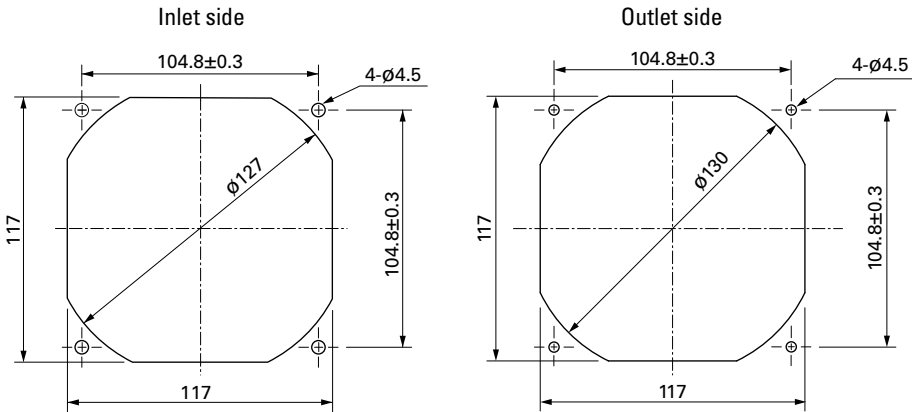

Options

Finger guards

page: p. 533

Model no.: 109-019E, 109-019K, 109-019C, 109-019H

Resin finger guards

page: p. 539

Model no.: 109-1000G

Resin filter kits

page: p. 540

Model no.: 109-1000F13 (13PPI), 109-1000F20 (20PPI),
109-1000F30 (30PPI), 109-1000F40 (40PPI)

X-ON Electronics

Largest Supplier of Electrical and Electronic Components

Click to view similar products for [DC Fans](#) category:

Click to view products by [Sanyo Denki](#) manufacturer:

Other Similar products are found below :

[F1238H24B-FHR](#) [F1238X24B1-FSR-TTL](#) [PMD1204PBB1-A \(2\).GN](#) [AUB0612L](#) [F6025X12B1-RHR](#) [G4020H05B2-RSR-EM](#) [4318/12T](#)
[AUB0912H-F00](#) [3412N/2ME](#) [W2G110-AM39-01](#) [USTF501005HW](#) [8412GLV](#) [8412NGL-12](#) [6448-384](#) [3258JH](#) [4114N/17-251](#) [4412F/2D](#)
[OD127AP-28HTB](#) [424JMU](#) [3110KL-05W-B50-G00](#) [1608KL-04W-B29-L00](#) [EF40101BX-1000U-G99](#) [4414/2HH](#) [512F/2P-549](#) [4112](#)
[N/12GL-175](#) [9GA0924L4021](#) [9GA0924M4021](#) [9GA0924M4011](#) [9GA0912M4D011](#) [9GA0924W4D01](#) [9GA0912F4021](#) [9GA0912H4D011](#)
[9GA0824L20021](#) [9GA0824L20011](#) [9GA0812A2002](#) [9GA0812B2D001](#) [9GA0812L20021](#) [9WP1248M1021](#) [9GA0812A2D001](#)
[9GA0824L2D001](#) [9GA0924W4D011](#) [9GA0912W402](#) [9GA0912M402](#) [9GA0824B2D001](#) [9GA0824A20021](#) [9GA0912W4021](#)
[9GA0924W402](#) [9GA0812L2D0011](#) [9GA0812A20021](#) [9GA0824L2001](#)