

Airflow - Static Pressure Characteristics / PWM Duty - Speed Characteristics Example

9LG0912P4G001 With pulse sensor with PWM control function

PWM duty cycle

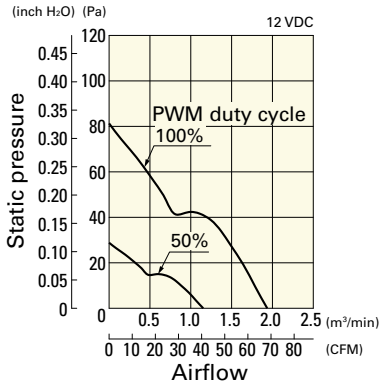

Operating voltage range

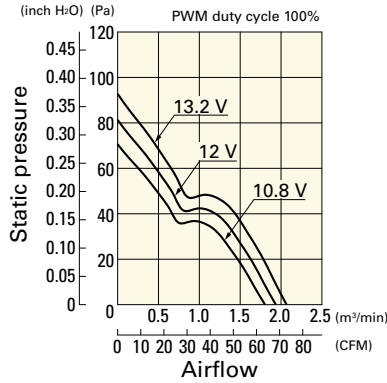

PWM duty - Speed characteristics example

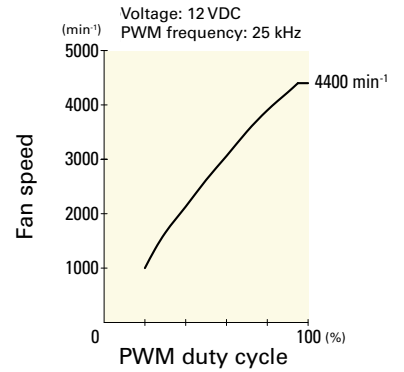

9LG0912P4S001 With pulse sensor with PWM control function

PWM duty cycle

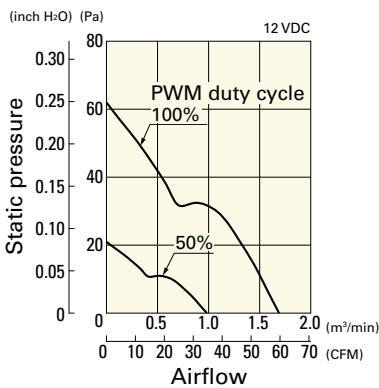

Operating voltage range

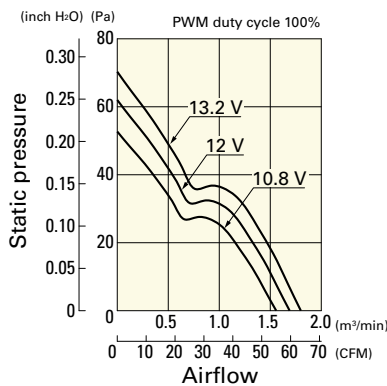

PWM duty - Speed characteristics example

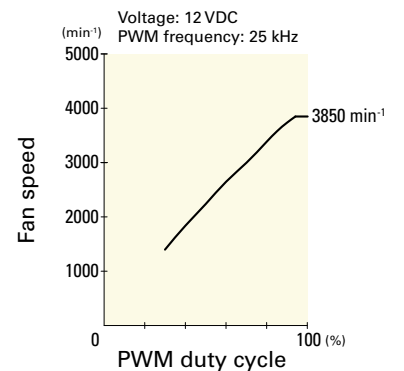

9LG0912P4H001 With pulse sensor with PWM control function

PWM duty cycle

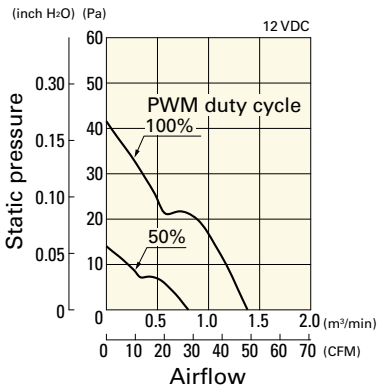

Operating voltage range

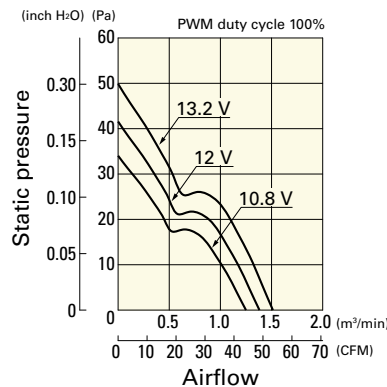

PWM duty - Speed characteristics example

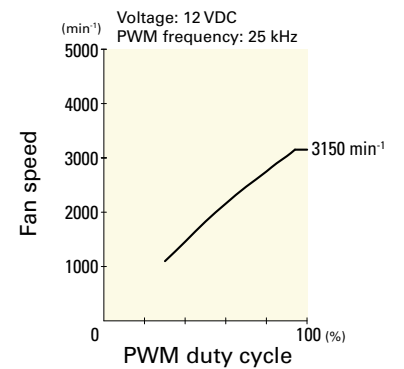

9LG0924P4J001 With pulse sensor with PWM control function

PWM duty cycle

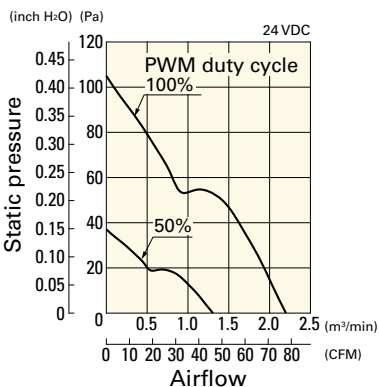

Operating voltage range

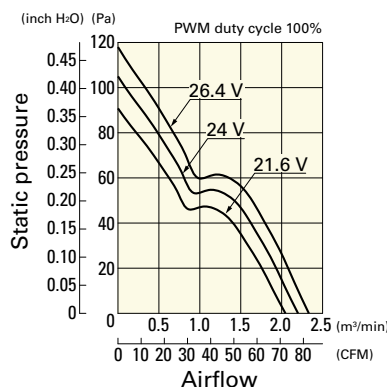

PWM duty - Speed characteristics example

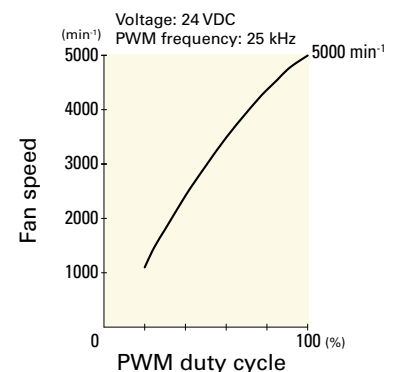

Airflow - Static Pressure Characteristics / PWM Duty - Speed Characteristics Example

9LG0924P4G001 With pulse sensor with PWM control function

PWM duty cycle

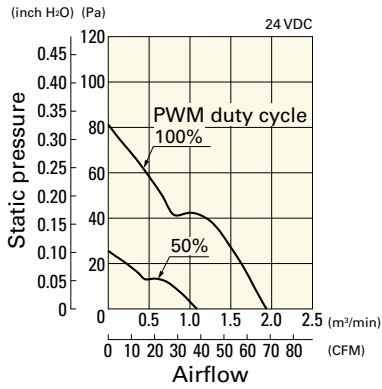

Operating voltage range

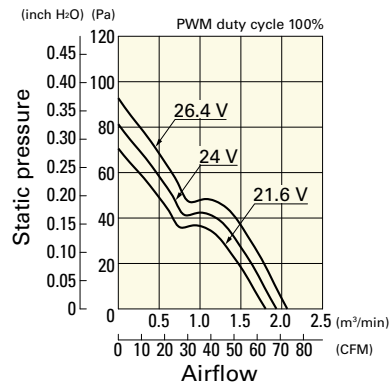

PWM duty - Speed characteristics example

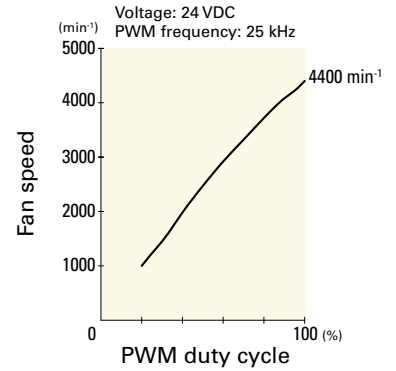

9LG0924P4S001 With pulse sensor with PWM control function

PWM duty cycle

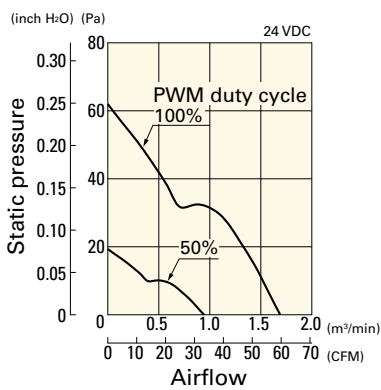

Operating voltage range

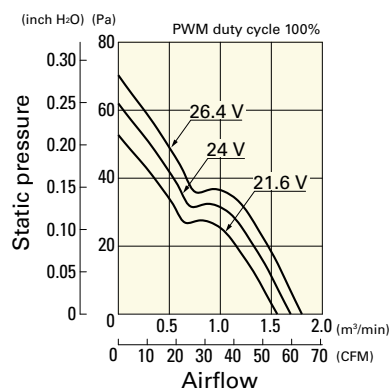

PWM duty - Speed characteristics example

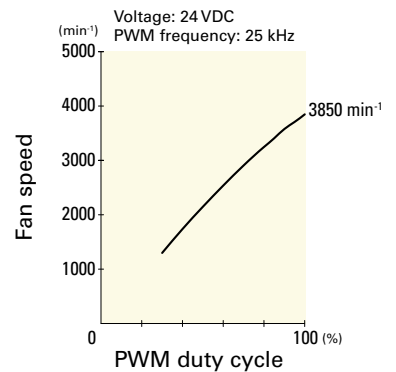

9LG0924P4H001 With pulse sensor with PWM control function

PWM duty cycle

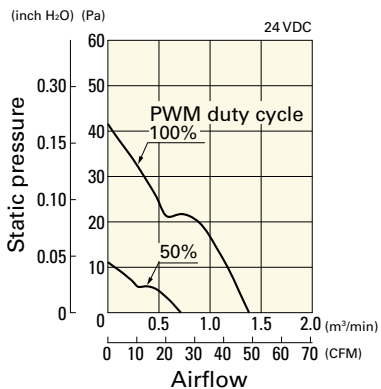

Operating voltage range

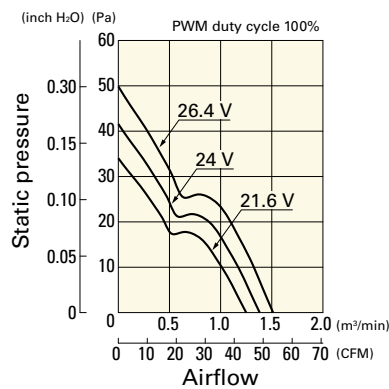

PWM duty - Speed characteristics example

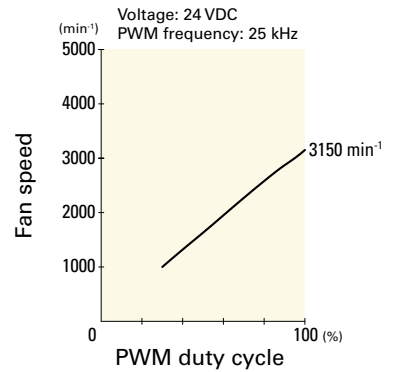

9LG0912F4001 With pulse sensor

Operating voltage range

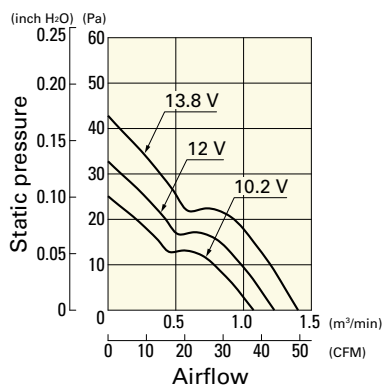

9LG0912M4001 With pulse sensor

Operating voltage range

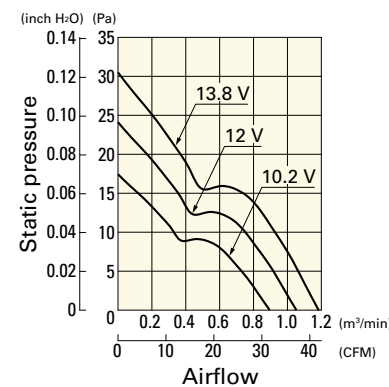

9LG0912L4001 With pulse sensor

Operating voltage range

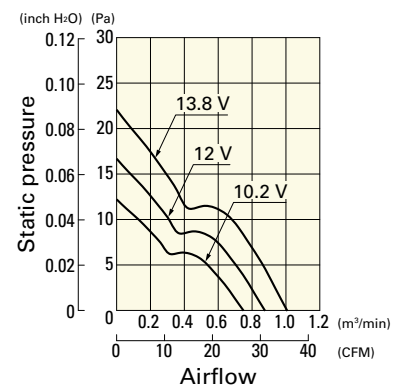

DC

Long Life Fan 92 mm sq.

Airflow - Static Pressure Characteristics

9LG0924F4001 With pulse sensor

Operating voltage range

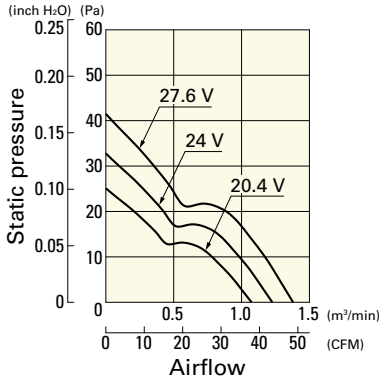

9LG0924M4001 With pulse sensor

Operating voltage range

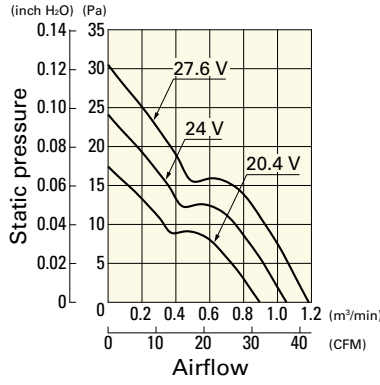

9LG0924L4001 With pulse sensor

Operating voltage range

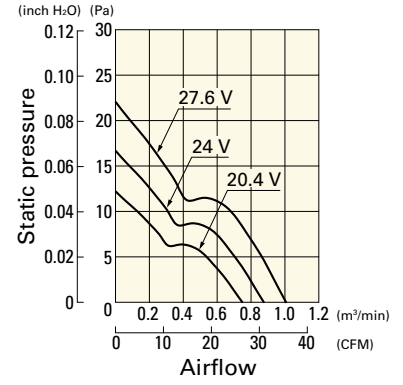

Dimensions (unit: mm)

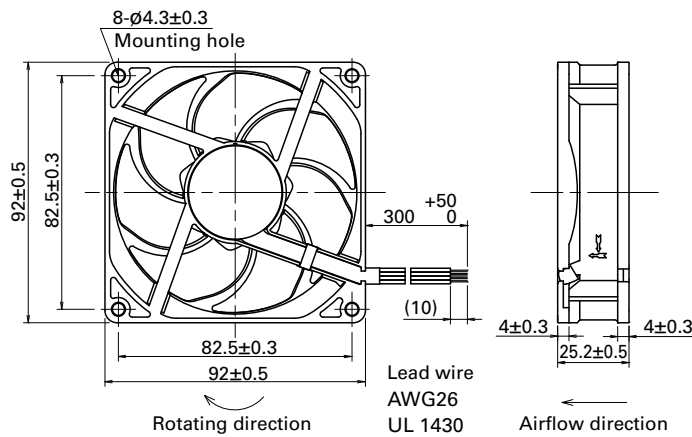

Reference Dimensions of Mounting Holes and Vent Opening (unit: mm)

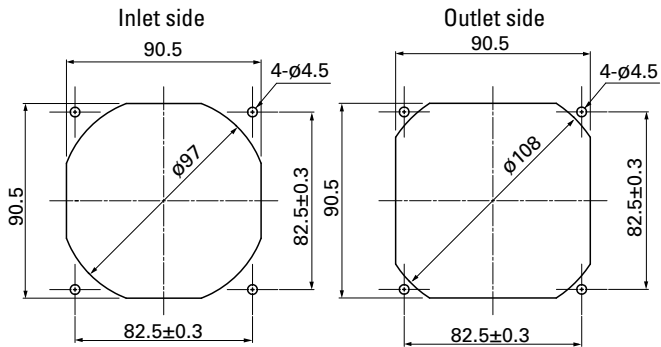

Options

Finger guards

page: p. 532

Model no.: 109-099E, 109-099H, 109-099C

Resin finger guards

page: p. 539

Model no.: 109-1001G

Resin filter kits

page: p. 540

Model no.: 109-1001F13 (13PPI), 109-1001F20 (20PPI),
109-1001F30 (30PPI), 109-1001F40 (40PPI)

X-ON Electronics

Largest Supplier of Electrical and Electronic Components

Click to view similar products for [DC Fans](#) category:

Click to view products by [Sanyo Denki](#) manufacturer:

Other Similar products are found below :

[614R](#) [6424/2HP-210](#) [8312R](#) [DV4118/2NP-183](#) [AFB0948HH-S687](#) [PFB0824DHE-8B72](#) [G2E085-AA05-10](#) [RD20S-4/210660](#) [4318/12T](#)
[4418HH](#) [AUB0912H-F00](#) [3412N/2ME](#) [K2E225-RA92-09](#) [4184N/2XR](#) [5214N2HH](#) [614J2HHPR-010](#) [8412NGL-12](#) [4114N/12HHR-297](#)
[4656](#) [ZWR-903](#) [4112N12GL-175](#) [KD2406PKB2.\(2\).GN](#) [AFB1248HHE](#) [AFB1212LE-F00](#) [FAN-SCH-1](#) [MF60151V1-1000U-G99](#)
[PF80252V1-1000U-G99](#) [PF92252V1-1000U-G99](#) [4112N/2H6P](#) [4114N/17-251](#) [6212NH](#) [622/2N](#) [712F-011](#) [8218J/2NP-181](#) [W1G180-AB47-](#)
[15](#) [FAA1-12038NBKW31-A](#) [6318N/2TDP](#) [6318N/2H3PU](#) [6318HU](#) [424JMU](#) [PMD1206PTVX-A.U.GN](#) [PF80251B2-000U-F99](#)
[EF40101BX-1000U-G99](#) [AD1224LB-A71GL](#) [9GA0924L4021](#) [9GA0924M4021](#) [9GA0924M4011](#) [9GA0824B20011](#) [9GA0812A2D0011](#)
[9GA0912M4D011](#) [9GA0924W4D01](#)