



# 120×120×38 mm

San Ace 120W 9WG type

DC  
Splash Proof Fan 120 mm sq.

## General Specifications

- Material ..... Frame: Aluminum (Black coating), Impeller: Plastic (Flammability: UL 94V-1)
- Expected life ..... See the table below. (L10 life: 90% survival rate for continuous operation in indoor free air at 60°C, rated voltage)  
Expected life at 40°C is for reference only.
- Motor protection function ..... Locked rotor burnout protection, Reverse polarity protection  
For details, please refer to p. 573.
- Dielectric strength ..... 50/60 Hz, 500 VAC, for 1 minute (between lead wire conductors and frame)
- Insulation resistance ..... 10 MΩ or more with a 500 VDC megger (between lead wire conductors and frame)
- Sound pressure level (SPL) ..... At 1 m away from the air inlet
- Storage temperature ..... -30 to +70°C (Non-condensing)
- Lead wire ..... ⊕Red ⊖Black or Blue  Sensor Yellow
- Mass ..... 410 g
- Ingress protection ..... IP55

## Specifications

The models listed below **have pulse sensors**.

Model no.	Rated voltage [V]	Operating voltage range [V]	Rated current [A]	Rated input [W]	Rated speed [min <sup>-1</sup> ]	Max. airflow [m <sup>3</sup> /min] [CFM]	Max. static pressure [Pa] [inchH <sub>2</sub> O]	SPL [dB (A)]	Operating temperature [°C]	Expected life [h]	
9WG1212G101-E	12	10.2 to 13.8	0.98	11.76	3600	3.88 137	135 0.542	49	-20 to +70	80000/60°C (115000/40°C)	
9WG1212E101-E			0.61	7.32	3100	3.34 118	100 0.402	46			
9WG1212H101-E		7 to 13.8	0.38	4.56	2600	2.8 99	70.4 0.283	39		100000/60°C (135000/40°C)	
9WG1212F101-E			0.28	3.36	2280	2.45 87	54.2 0.218	36			
9WG1212M101-E			0.21	2.52	1950	2.1 74	39.6 0.159	32			
9WG1224G101-E	24	20.4 to 27.6	0.5	12	3600	3.88 137	135 0.542	49		-20 to +70	80000/60°C (115000/40°C)
9WG1224E101-E			0.34	8.16	3100	3.34 118	100 0.402	46			
9WG1224H101-E		14 to 27.6	0.22	5.28	2600	2.8 99	70.4 0.283	39			100000/60°C (135000/40°C)
9WG1224F101-E			0.16	3.84	2280	2.45 87	54.2 0.218	36			
9WG1224M101-E			0.11	2.64	1950	2.1 74	39.6 0.159	32			
9WG1248G101-E	48	40.8 to 55.2	0.25	12	3600	3.88 137	135 0.542	49	-20 to +70		80000/60°C (115000/40°C)
9WG1248E101-E			0.17	8.16	3100	3.34 118	100 0.402	46			
9WG1248H101-E			0.11	5.28	2600	2.8 99	70.4 0.283	39			100000/60°C (135000/40°C)
9WG1248F101-E			0.09	4.32	2280	2.45 87	54.2 0.218	36			
9WG1248M101-E			0.07	3.36	1950	2.1 74	39.6 0.159	32			

The following sensor and control options are available for selection.

Available for all models.  Without sensor  Lock sensor

## Airflow - Static Pressure Characteristics

9WG1212G101-E With pulse sensor

Operating voltage range

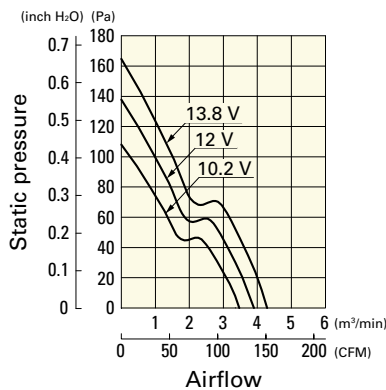

9WG1212E101-E With pulse sensor

Operating voltage range

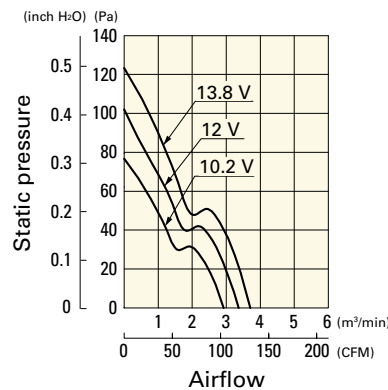

9WG1212H101-E With pulse sensor

Operating voltage range

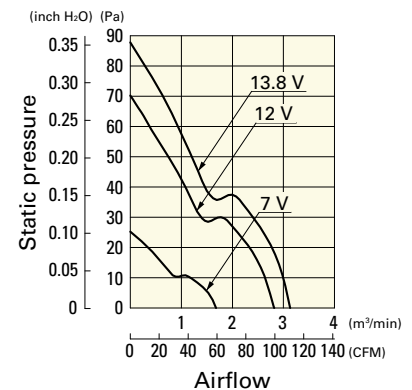

# Airflow - Static Pressure Characteristics

**9WG1212F101-E** With pulse sensor

Operating voltage range

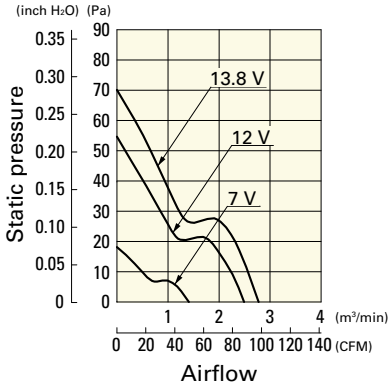

**9WG1212M101-E** With pulse sensor

Operating voltage range

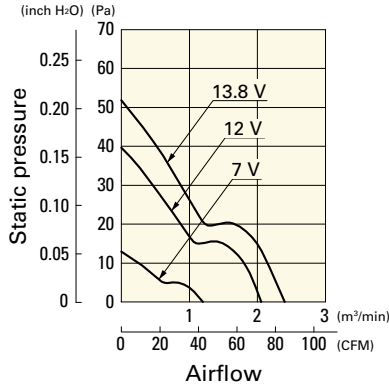

**9WG1224G101-E** With pulse sensor

Operating voltage range

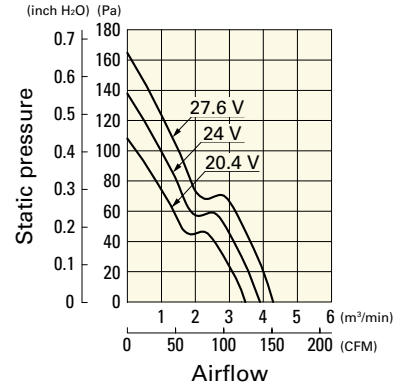

**9WG1224E101-E** With pulse sensor

Operating voltage range

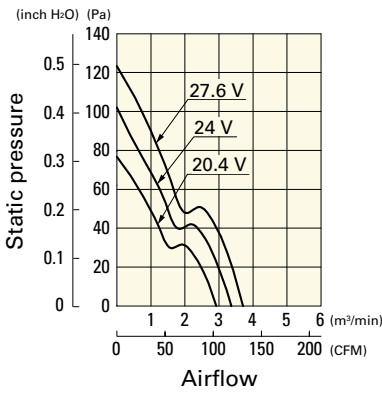

**9WG1224H101-E** With pulse sensor

Operating voltage range

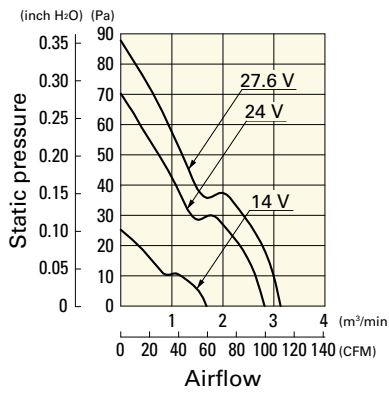

**9WG1224F101-E** With pulse sensor

Operating voltage range

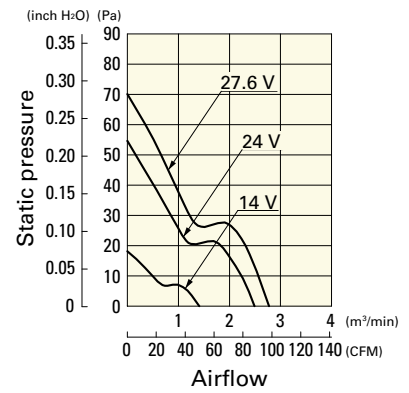

**9WG1224M101-E** With pulse sensor

Operating voltage range

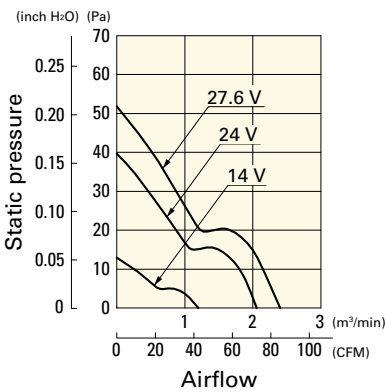

**9WG1248G101-E** With pulse sensor

Operating voltage range

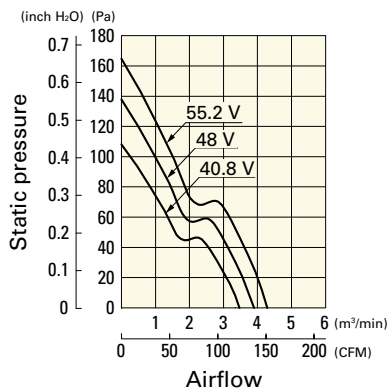

**9WG1248E101-E** With pulse sensor

Operating voltage range

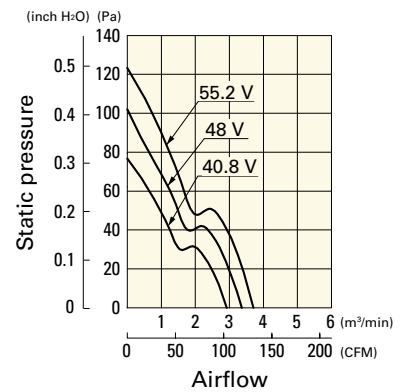

**9WG1248H101-E** With pulse sensor

Operating voltage range

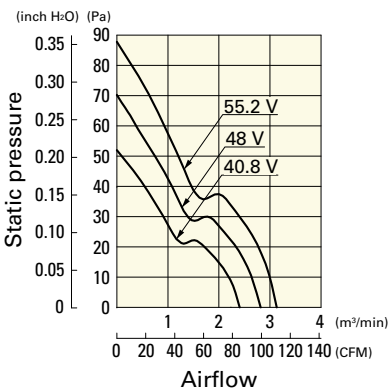

**9WG1248F101-E** With pulse sensor

Operating voltage range

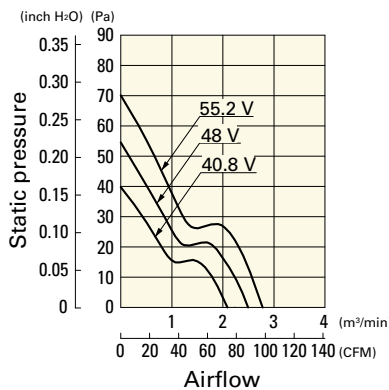

**9WG1248M101-E** With pulse sensor

Operating voltage range

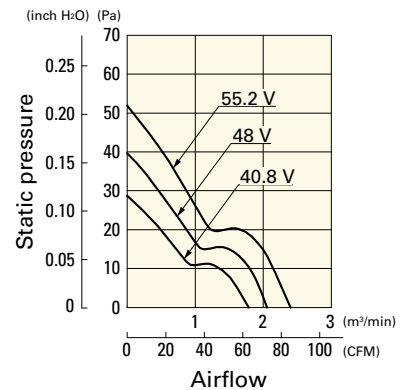

**Dimensions (unit: mm)**

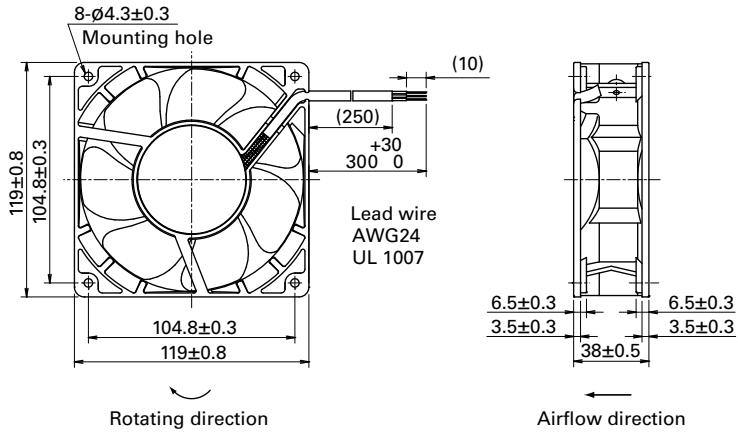

**Reference Dimensions of Mounting Holes and Vent Opening (unit: mm)**

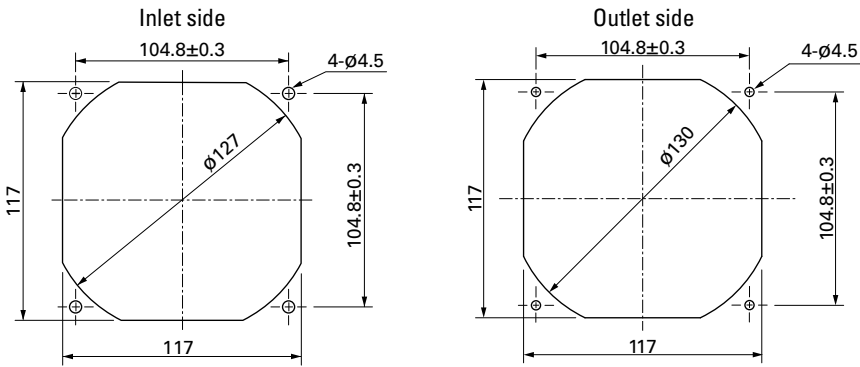

**Options**

**Finger guards**

page: p. 559

Model no.: 109-019E, 109-019K, 109-019C, 109-019H

**Resin finger guards**

page: p. 565

Model no.: 109-1000G

## X-ON Electronics

Largest Supplier of Electrical and Electronic Components

*Click to view similar products for [DC Fans](#) category:*

*Click to view products by [Sanyo Denki](#) manufacturer:*

Other Similar products are found below :

[AUB0612L](#) [AFB0948HH-S687](#) [G2E085-AA05-10](#) [4318/12T](#) [AUB0912H-F00](#) [3412N/2ME](#) [W2G110-AM39-01](#) [8412GLV](#) [8412NGL-12](#)  
[6448-384](#) [4114N/17-251](#) [4318/2R](#) [4412F/2D](#) [424JMU](#) [4414/2HH](#) [4112 N/12GL-175](#) [9GA0924L4021](#) [9GA0924M4021](#) [9GA0924M4011](#)  
[9GA0812A2D0011](#) [9GA0912M4D011](#) [9GA0924W4D01](#) [9GA0912F4021](#) [9GA0912F402](#) [9GA0912H4D011](#) [9GA0824L20021](#)  
[9GA0824L20011](#) [9GA0812A2002](#) [9GA0812B20011](#) [9GA0812B2D001](#) [9GA0812L20021](#) [9WP1248M1021](#) [9GA0812A2D001](#)  
[9GA0824L2D001](#) [9GA0924W4D011](#) [9GA0912W402](#) [9GA0912M402](#) [9GA0824B2D001](#) [9GA0824A20021](#) [9GA0912W4021](#)  
[9GA0924W402](#) [9GA0812L2D0011](#) [9GA0812A20021](#) [9GA0824B2D0011](#) [9GA0824L2001](#) [9GA0824L2002](#) [9GA0812L2D001](#)  
[9GA0824L2D0011](#) [9GA0912M401](#) [9GA0924M402](#)