



92x92x38 mm

San Ace 92W 9WL type   

General Specifications

- Material Frame: Aluminum (Black coating), Impeller: Plastic (Flammability: UL 94V-1)
- Expected life See the table below. (L10 life: 90% survival rate for continuous operation in indoor free air at 60°C, rated voltage)
- Motor protection function Locked rotor burnout protection, Reverse polarity protection
For details, please refer to p. 547.
- Dielectric strength 50/60 Hz, 500 VAC, for 1 minute (between lead wire conductors and frame)
- Insulation resistance 10 MΩ or more with a 500 VDC megger (between lead wire conductors and frame)
- Sound pressure level (SPL) At 1 m away from the air inlet
- Storage temperature -30 to +70°C (Non-condensing)
- Lead wire ⊕Red ⊖Black (Sensor) Yellow (Control) Brown
- Mass 300 g
- Ingress protection IP68

Specifications

The models listed below **have pulse sensors with PWM control function.**

Model no.	Rated voltage [V]	Operating voltage range [V]	PWM duty cycle* [%]	Rated current [A]	Rated input [W]	Rated speed [min ⁻¹]	Max. airflow [m ³ /min] [CFM]	Max. static pressure [Pa] [inchH ₂ O]	SPL [dB (A)]	Operating temperature [°C]	Expected life [h]
9WL0912P1H001	12	10.2 to 13.2	100	1.9	22.8	9000	3.7 130.6	430 1.72	61	-20 to +70	100000/60°C
			20	0.13	1.56	2700	1.11 39.1	48.0 0.19	30		
9WL0912P1F001			100	0.95	11.4	7000	2.9 102.4	263 1.05	55		
			20	0.1	1.2	2000	0.83 29.3	26.3 0.1	22		
9WL0924P1H001	24	20.4 to 26.4	100	0.95	22.8	9000	3.7 130.6	430 1.72	61		
			20	0.07	1.68	2700	1.11 39.1	48.0 0.19	30		
9WL0924P1F001			100	0.5	12	7000	2.9 102.4	263 1.05	55		
			20	0.06	1.44	2000	0.83 29.3	26.3 0.1	22		
9WL0948P1H601	48	40.8 to 52.8	100	0.48	23.04	9000	3.7 130.6	430 1.72	61		
			20	0.05	2.4	2700	1.11 39.1	48.0 0.19	30		
9WL0948P1F601			100	0.24	11.52	7000	2.9 102.4	263 1.05	55		
			20	0.05	2.4	2000	0.83 29.3	26.3 0.1	22		

* PWM frequency: 25 kHz. Fan does not rotate when PWM duty cycle is 0%.

Airflow - Static Pressure Characteristics / PWM Duty - Speed Characteristics Example

9WL0912P1H001 With pulse sensor with PWM control function

PWM duty cycle

Operating voltage range

PWM duty - Speed characteristics example

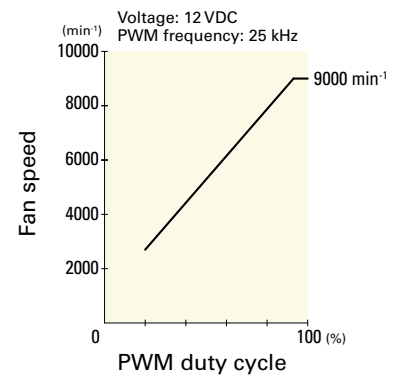
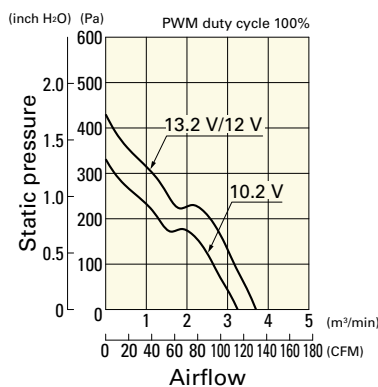
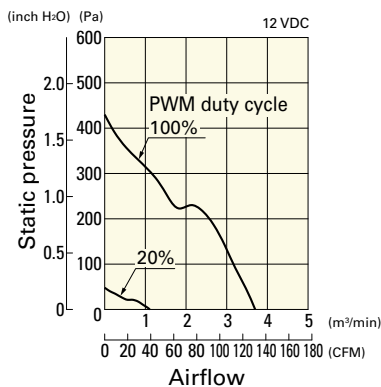

Airflow - Static Pressure Characteristics / PWM Duty - Speed Characteristics Example

9WL0912P1F001 With pulse sensor with PWM control function

PWM duty cycle

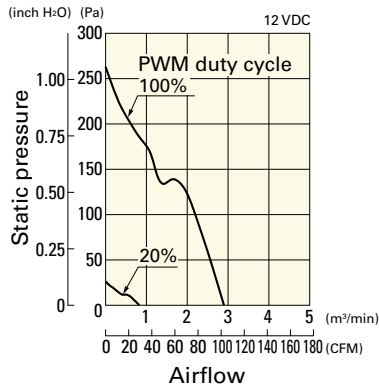

Operating voltage range

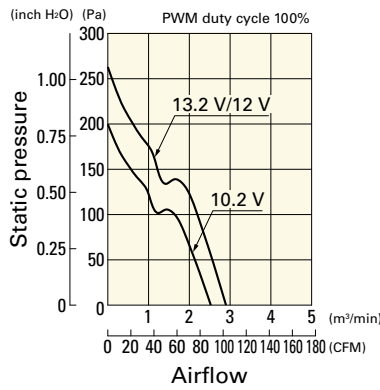

PWM duty - Speed characteristics example

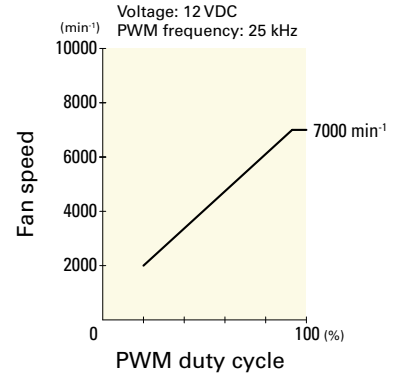

9WL0924P1H001 With pulse sensor with PWM control function

PWM duty cycle

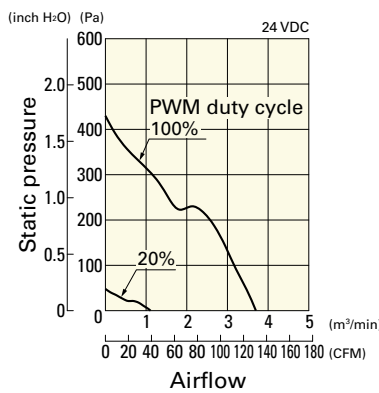

Operating voltage range

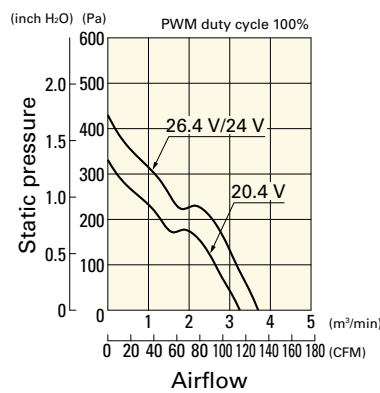

PWM duty - Speed characteristics example

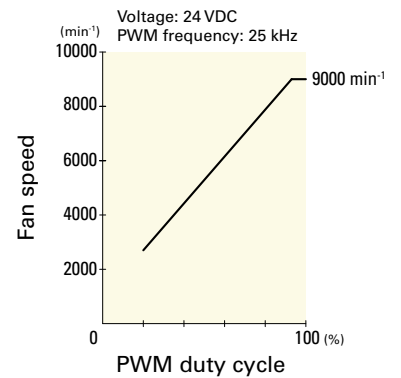

9WL0924P1F001 With pulse sensor with PWM control function

PWM duty cycle

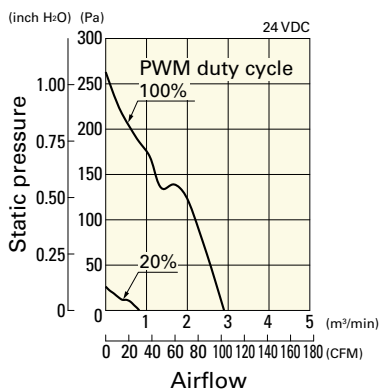

Operating voltage range

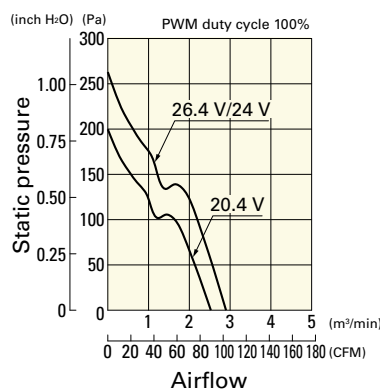

PWM duty - Speed characteristics example

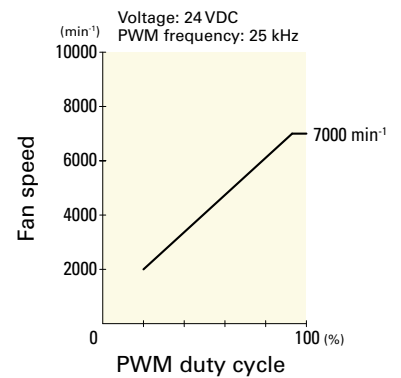

9WL0948P1H601 With pulse sensor with PWM control function

PWM duty cycle

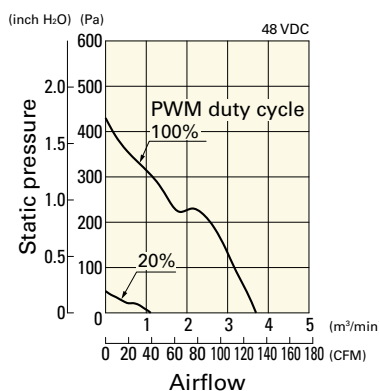

Operating voltage range

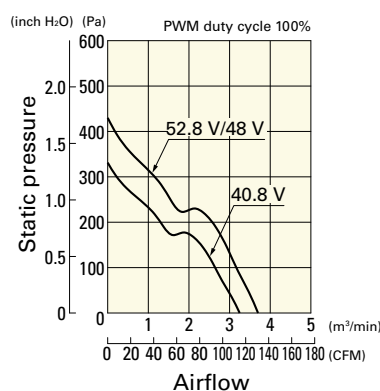

PWM duty - Speed characteristics example

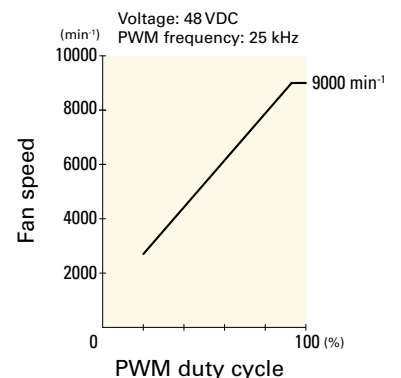

Airflow - Static Pressure Characteristics / PWM Duty - Speed Characteristics Example

9WL0948P1F601 With pulse sensor with PWM control function

PWM duty cycle

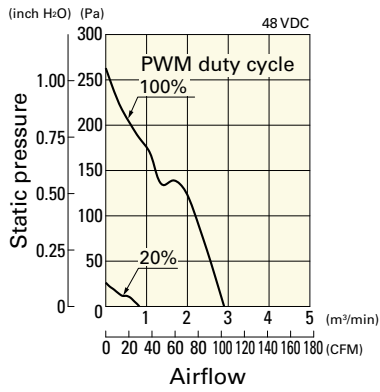

Operating voltage range

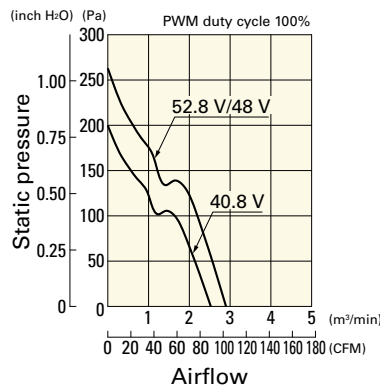

PWM duty - Speed characteristics example

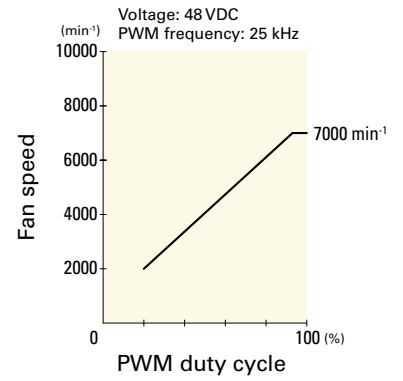

Dimensions (unit: mm)

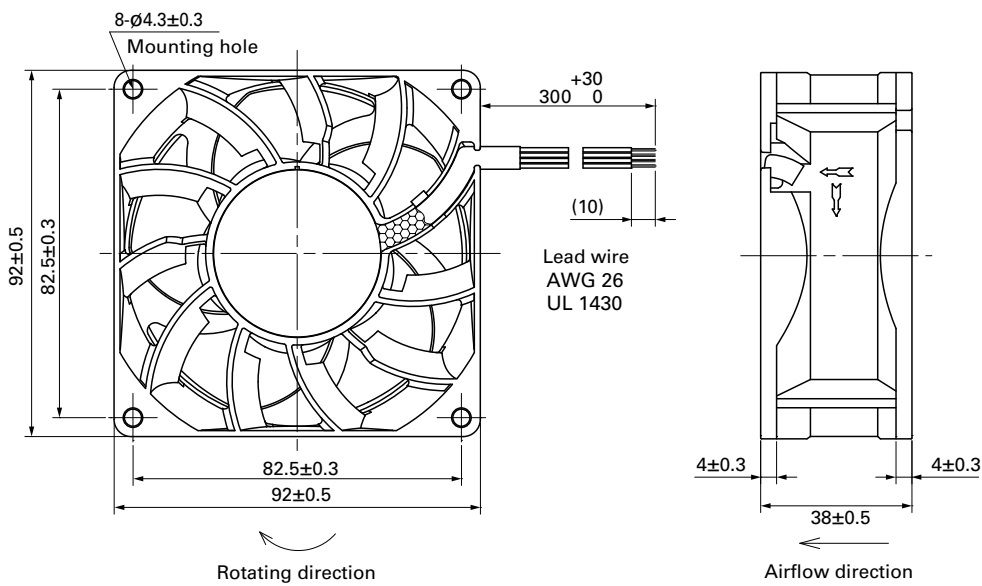

Reference Dimensions of Mounting Holes and Vent Opening (unit: mm)

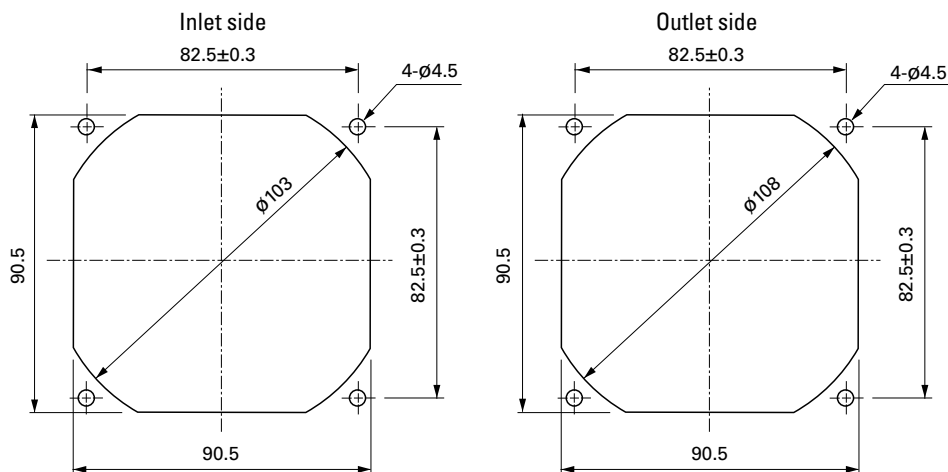

Options

Finger guards

page: p. 532

Model no.: 109-099E, 109-099H, 109-099C

Resin finger guards

page: p. 539

Model no.: 109-1001G

X-ON Electronics

Largest Supplier of Electrical and Electronic Components

Click to view similar products for [DC Fans](#) category:

Click to view products by [Sanyo Denki](#) manufacturer:

Other Similar products are found below :

[614R](#) [AUB0612L](#) [AFB0948HH-S687](#) [G2E085-AA05-10](#) [4318/12T](#) [AUB0912H-F00](#) [3412N/2ME](#) [W2G110-AM39-01](#) [8412GLV](#) [8412NGL-12](#) [6448-384](#) [4114N/17-251](#) [4318/2R](#) [4412F/2D](#) [424JMU](#) [4414/2HH](#) [4112 N/12GL-175](#) [9GA0912F402](#) [9GA0812B20011](#)
[AFB0824SHBAV1](#) [DV5214/2NP-230](#) [9GA0912H4021](#) [THC1548MGDJJ](#) [9GA0812B2001](#) [GFB1224SHG](#) [8500NU](#) [9WG1212E101-E](#)
[3241.124](#) [DC1203812W2B-2T0](#) [MF40060V1-1000U-G99](#) [DC0401012V2B-3T0](#) [ASFP14391](#) [ASFP64371](#) [ASFP64391](#) [ASFP84391](#)
[ASFP92391](#) [9A0612G402](#) [AD5012HB-C71](#) [AD5012MB-C71](#) [ASFP84372](#) [ASFP64372](#) [31100-000440-RS](#) [026758A](#) [514F](#) [MEC0381V1-000U-G99](#) [4292](#) [MF40101V2-1000U-A99](#) [MF60152V1-1000U-G99](#) [3610KL-04W-B50-D00](#) [109P0412K3023](#)